

# Construction & Material Handling Tyres

## Technical Databook

Edition 2018/2019





## **Mitas Technical Databook for Construction & Material Handling Tyres – World edition 2018 / 2019**

The extensive technical data and other information relating to tyres and accessories on the following pages has been compiled to reflect as accurately and completely as possible the current state of development. Due to changes in our product range the tyre sizes given in this guide are not always identical to our available range.

Mitas, part of Trelleborg group, is one of Europe's leading tire brands for agricultural machines, construction vehicles, material handling equipment, motorcycles, bicycles and other specialty segments. Mitas tires are being produced in the Czech Republic, the United States, Serbia, Slovenia and promoted through a global sales and distribution network.

For further information please contact us:

**Trelleborg Wheel Systems Czech Republic a.s.**

Švehlova 1900/3, 106 00 Prague 10, Czech Republic

# Contents

## Tread patterns, markings and definitions

List of tread patterns . . . . .	4
List of tyre sizes . . . . .	6
Tyre size marking . . . . .	8
Speed symbols and conversion tables . . . . .	9
Tyre sidewall marking and structures . . . . .	10
Load index . . . . .	11

### Earthmover Tyres

EM – Earthmover Radial – Light equipment . . . . .	12
EM – Earthmover Diagonal . . . . .	18
Light Equipment Diagonal . . . . .	26
Excavator . . . . .	34
Roller & Tractor Grader . . . . .	38

### Crane Tyres

CR – Crane Radial . . . . .	44
-----------------------------	----

### Multipurpose Tyres

MPT – Multipurpose Radial . . . . .	48
MPT – Multipurpose Diagonal . . . . .	54

### Tractor Industrial Tyres

TI – Tractor Industrial Radial . . . . .	58
Construction Applications Diagonal . . . . .	62

### Skid Steer Tyres

SK – Skid Steer . . . . .	72
---------------------------	----

### Material Handling Tyres

FLR – Material Handling Radial . . . . .	78
FL – Material Handling Diagonal . . . . .	82

## Use and Maintenance

Use and Maintenance . . . . .	88
Fitting and removal instructions . . . . .	89
Earthmover tyres general information . . . . .	90
List of homologations . . . . .	93
Rim specification . . . . .	94
Terms and abbreviations used in this catalogue . . . . .	98

Tread patterns

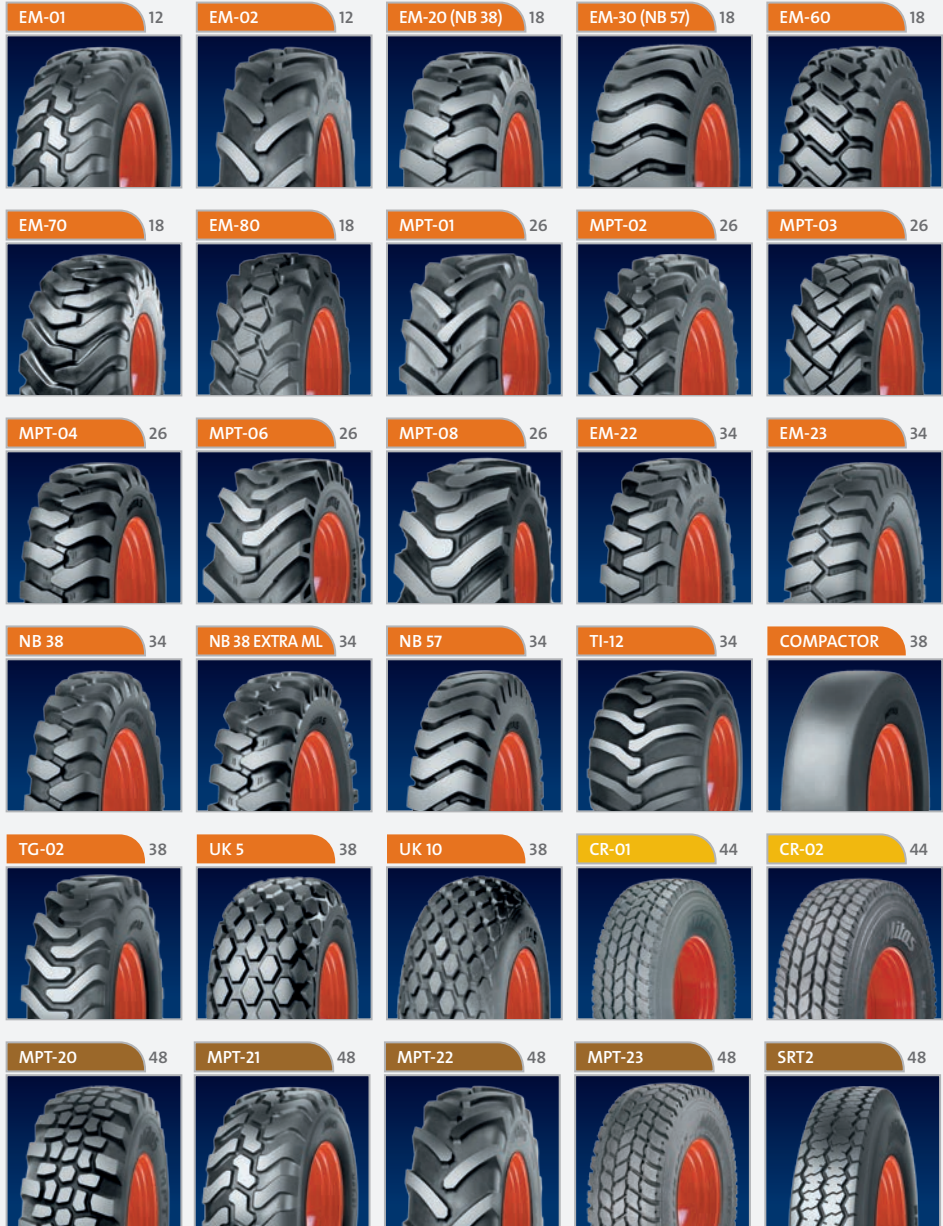

Legend:

Earthmover Tyres

Page 12

Crane Tyres

Page 44

Multipurpose Tyres

Page 48



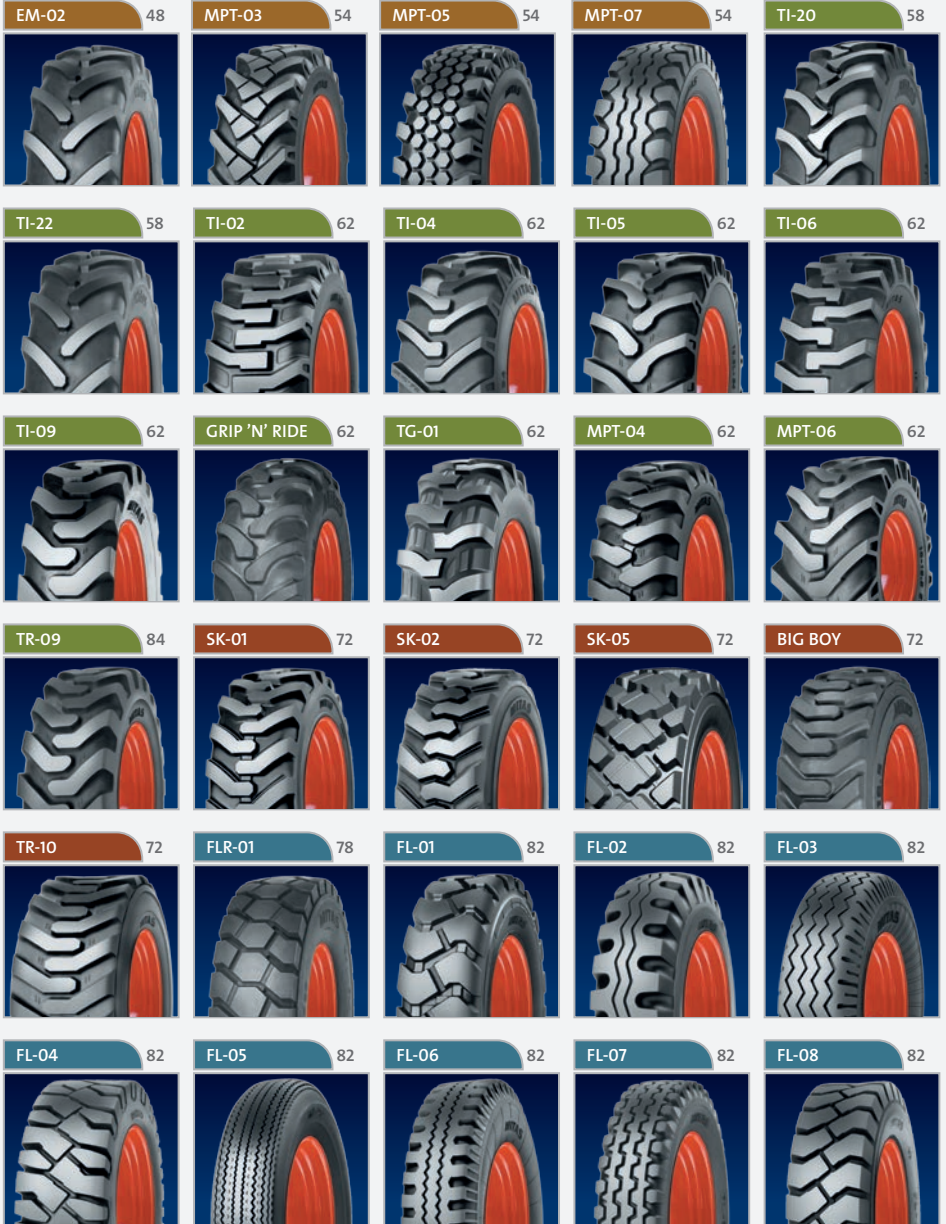

# List of tyre sizes

Size (inch)	Tyre size (Alternative tyre size)	Tread pattern	Page
<b>EM Radial Tyres</b>			
18"	335/80 R 18 (12.5 R 18)	EM-02	14
	365/70 R 18	EM-01	14
	405/70 R 18 (16/70 R 18)	EM-01	14
20"	335/80 R 20 (12.5 R 20)	EM-01	14
	365/80 R 20 (14.5 R 20)	EM-01	14
	405/70 R 20 (16/70 R 20)	EM-01	14
24"	405/70 R 24 (16/70 R 24)	EM-01	16
	440/70 R 24 (17.5L R 24)	EM-02	16
	500/70 R 24	EM-01	16
<b>EM Diagonal Tyres</b>			
24"	20-24 (22/70-24)	EM-70	20
25"	15.5-25	EM-20	20
	15.5-25	NB 57	20
	15.5-25	EM-60	20
	15.5-25	EM-80	20
	17.5-25	EM-20	20
	17.5-25	EM-30	20
	17.5-25	EM-60	20
	17.5-25	EM-80	22
	18.00-25	NB 38	22
	18.00-25	EM-30	22
	20.5-25	EM-20	22
	20.5-25	EM-30	22
	20.5-25	EM-60	22
	23.5-25	EM-30	24
	23.5-25	EM-60	24
	26.5-25	EM-30	24
	26.5-25	EM-60	24
29"	26.5-29	NB 57	24
<b>Light Equipment Diagonal Tyres</b>			
18"	280/80-18 (10.5-18)	MPT-01	28
	10.5-18	MPT-02	28
	340/80-18 (12.5-18)	MPT-01	28
19.5"	18-19.5	MPT-02	28
	18-19.5	MPT-03	30
	18-19.5	MPT-06	30
	18-19.5	MPT-08	30
20"	10.5-20	MPT-04	30
	340/80-20 (12.5-20)	MPT-01	30
	16/70-20 (405/70-20)	MPT-02	30
24"	405/70-20 (16/70-20)	MPT-01	32
	405/70-24 (16/70-24)	MPT-01	32
<b>Excavator Diagonal Tyres</b>			
20"	8.25-20	NB 38	36
	8.25-20	NB 38 Extra ML	36
	9.00-20	NB 38	36
	9.00-20	NB 38 Extra ML	36
	9.00-20	EM-22	36
	10.00-20	NB 38	36

Size (inch)	Tyre size (Alternative tyre size)	Tread pattern	Page
	10.00-20	NB 38 Extra ML	36
	10.00-20	EM-22	36
	10.00-20	EM-23	36
	11.00-20	NB 38	36
	11.00-20	EM-22	36
	11.00-20	NB 57	36
	500/45-20	TI-12	36
22.5"	500/60-22.5	TI-12	36
	600/40-22.5	TI-12	36
<b>Roller &amp; Tractor Grader Tyres</b>			
15"	9.5/65-15	COMPACTOR	40
16"	10.5/80-16	COMPACTOR	40
	11.00-20	COMPACTOR	40
	11.00-20	COMP. EXTRA	40
	11.00-20	COMP.SMOOTH	40
	11.00 R 20	COMPACTOR	40
	13/80 R 20	COMPACTOR	40
24"	13.00-24	TG-02	42
	14.00-24	TG-02	42
	14.9-24 IND	UK 5	42
	16.9-24 IND	UK 10	42
26"	23.1-26 IND	UK 5	42
	23.1-26 IND	UK 10	42
<b>Crane Radial Tyres</b>			
25"	335/95 R 25	CR-01	46
	445/95 R 25	CR-01	46
	445/95 R 25	CR-02	46
	525/80 R 25	CR-01	46
<b>Multipurpose Radial Tyres</b>			
18"	335/80 R 18 (12.5 R 18)	EM-02	50
20"	335/80 R 20 (12.5 R 20)	MPT-20	50
	335/80 R 20 (12.5 R 20)	MPT-21	50
	365/80 R 20 (14.5 R 20)	MPT-20	50
	365/80 R 20 (14.5 R 20)	MPT-21	50
	405/70 R 20 (16/70 R 20)	MPT-21	50
22.5"	275/90 R 22.5	SRT2	52
	375/75 R 22.5	MPT-23	52
24"	405/70 R 24 (16/70 R 24)	MPT-21	52
	445/70 R 24 (17.5L R 24)	MPT-22	52
<b>Multipurpose Diagonal Tyres</b>			
18"	12.5-18	MPT-03	56
20"	10.5-20	MPT-05	56
	10.5-20	MPT-07	56
	12.5-20	MPT-03	56
	12.5-20	MPT-05	56
	14.5-20	MPT-03	56
	14.5-20	MPT-05	56
	16/70-20 (405/70-20)	MPT-05	56
	405/70-20 (16/70-20)	MPT-03	56

Size (inch)	Tyre size (Alternative tyre size)	Tread pattern	Page
<b>Tractor Industrial Radial Tyres</b>			
18"	340/80 R 18 IND	TI-20	60
24"	460/70 R 24 IND (17.5L R 24)	TI-22	60
26"	480/80 R 26 IND	TI-20	60
28"	440/80 R 28 IND	TI-20	60
<b>Construction Applications Diagonal Tyres</b>			
18"	320/80-18 IND (12.5/80-18)	TR-09	64
	340/80-18 IND (12.5-18)	MPT-04	66
20"	340/80-20 IND (12.5-20)	MPT-04	66
	360/85-20 IND (14.5-20)	MPT-04	66
	400/70-20 IND (16.0/70-20)	MPT-04	66
	400/75-20 IND (16.0/70-20)	TR-09	64
22.5"	480/65-22.5 IND (18-22.5)	MPT-06	66
24"	400/70-24 IND	MPT-04	66
	400/80-24 IND (15.5/80-24)	TI-05	68
	16.9-24 IND	TI-04	68
	16.9-24	TG-01	68
	17.5L-24 IND	TI-02	68
	460/70-24 IND (17.5L-24)	TI-05	68
	19.5L-24 IND	TI-05	68
	19.5L-24 IND	GRIP-n-RIDE	68
	500/70-24 IND (19.5L-24)	TI-05	68
26"	18.4-26 IND	TI-06	70
28"	16.9-28 IND	TI-06	70
	16.9-28	TG-01	70
30"	440/80-30 IND (16.9-30)	TI-09	70
<b>Skid Steer Tyres (diagonal)</b>			
12"	23×8.50-12	SK-02	74
15"	27×8.50-15	SK-02	74
	27×10.50-15	SK-02	74
	31×15.50-15	SK-02	74
15.3"	10.0/75-15.3	SK-01	74
16.5"	10-16.5	SK-02	76
	10-16.5	SK-05	76
	10-16.5	BIG BOY	76
	12-16.5	SK-02	76
	12-16.5	SK-05	76
	12-16.5	BIG BOY	76
17.5"	14-17.5 IND	TR-10	76
18"	10.5/80-18	BIG BOY	76
	12.5/80-18	BIG BOY	76

Size (inch)	Tyre size (Alternative tyre size)	Tread pattern	Page
<b>Material Handling Radial Tyres</b>			
9"	6.00 R 9	FLR-01	80
10"	6.50 R 10	FLR-01	80
12"	7.00 R 12	FLR-01	80
15"	8.25 R 15	FLR-01	80
20"	12.00 R 20	FLR-01	80
<b>Material Handling Diagonal Tyres</b>			
8"	4.00-8	FL-03	84
	4.00-8	FL-08	84
	5.00-8	FL-01	84
	5.00-8	FL-03	84
	5.00-8	FL-08	84
	16×6-8	FL-08	84
	18×7-8	FL-08	84
9"	6.00-9	FL-01	84
	6.00-9	FL-02	84
	6.00-9	FL-08	84
	21×8-9	FL-08	84
10"	6.50-10	FL-01	84
	6.50-10	FL-02	84
	6.50-10	FL-08	84
	23×9-10	FL-08	84
12"	7.00-12	FL-01	84
	7.00-12	FL-02	84
	7.00-12	FL-08	84
	250/75-12 (27×10-12)	FL-08	84
13"	23×5	FL-05	84
	23×5	FL-07	84
15"	7.50-15	FL-08	84
	8.15-15	FL-04	86
	8.15-15	FL-08	86
	8.25-15	FL-06	86
	8.25-15	FL-08	86
	250-15	FL-08	86
	300-15	FL-08	86

## Tyre size marking

440/70 R 24	
440	Nominal section width (in mm)
70	Aspect ratio H/SW (in %)
R	Radial construction
24	Nominal rim diameter (in inches)

16/70 - 20	
16	Nominal section width (in inches)
70	Aspect ratio H/SW (in %)
-	Cross-ply construction
20	Nominal rim diameter (in inches)

27×8.50 - 12	
27	Overall diameter (in inches)
8.5	Nominal section width (in inches)
-	Cross-ply construction
12	Nominal rim diameter (in inches)

17.5 L-24	
17.5	Nominal section width (in inches)
L	Reduced aspect ratio
-	Cross-ply construction
24	Nominal rim diameter (in inches)

12.5 - 18	
12.5	Nominal section width (in inches)
-	Cross-ply construction
18	Nominal rim diameter (in inches)

23×5	
23	Overall diameter (in inches)
5	Nominal section width (in inches)

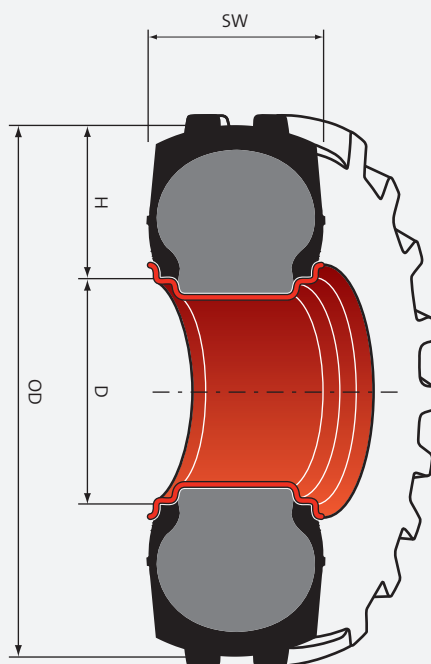

SW Section width  
 OD Overall diameter  
 H Section height  
 D Rim diameter



# Speed symbols and conversion tables

## Speed category

Speed symbol	A1	A2	A3	A4	A5	A6	A7	A8	B	D	F	G	J	K
Speed (km/h)	5	10	15	20	25	30	35	40	50	65	80	90	100	110

## Pressure units conversion table

bar	1.0	1.5	2.0	2.5	3.0	3.5	4.0	4.5	5.0	5.5
kPa	100	150	200	250	300	350	400	450	500	550
p. s. i.	15	22	29	36	44	51	58	65	73	80

bar	6.0	6.5	7.0	7.5	8.0	8.5	9.0	9.5	10.0	10.5
kPa	600	650	700	750	800	850	900	950	1 000	1 050
p. s. i.	87	94	102	109	116	123	131	138	145	152

## Units conversion table

Length	Mass	Pressure
1 millimeter (mm) = 0.03937"	1 pound (lb) = 0.4536 kg	1 p. s. i. (lb/in <sup>2</sup> ) = 6.895 kPa
1 inch (") = 25.4 mm = 0.0254 m	1 kilogram (kg) = 2.205 lb	1 kg/cm <sup>2</sup> = 98.066 kPa
1 meter (m) = 3.281 ft		1 bar = 100 kPa
1 foot (ft) = 0.3048 m	Volume	
1 kilometer (km) = 0.6214 mile	1 litre (l) = 0.21 gall	
1 mile = 1 609 m = 1.609 km	1 imperial gallon (imp.gal) = 4.55 l	

## Tyre sidewall marking



Sign	Meaning
MITAS	Trademark of producer
440/70 R 24	Tyre size marking
17.5 LR 24	Alternative size marking
EM-02	Tread pattern code
147	Load index (LI 147 = 3 075 kg)
B	Speed symbol (B = 50 km/h)
164	Load index (LI 164 = 5 020 kg)
A2	Speed symbol (A2 = 10 km/h)
TUBELESS	Tubeless tyre
↻	Direction of rotation

## Tyre structure

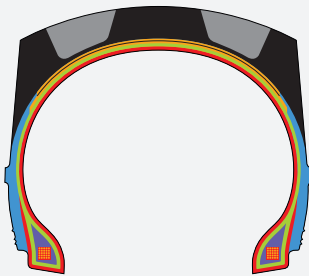

- Tread Pattern
- Breaker Cord
- Inner Liner
- Carcass Cord
- Sidewall
- Apex
- Bead Wire



### BIAS (DIAGONAL, CROSS-PLY) TYRE

A pneumatic tyre in which the ply cords extend to the beads and are laid substantially at alternate angles less than 90° to the centre-line of the tread.



### RADIAL PLY TYRE

A pneumatic tyre in which the ply cords extend to the beads and are laid substantially at 90° to the centre-line of the tread, the carcass being stabilised by an essentially inextensible circumferential belt.

## Load index

LI	kg	LI	kg	LI	kg	LI	kg	LI	kg
80	450	107	975	134	2 120	161	4 625	188	10 000
81	462	108	1 000	135	2 180	162	4 750	189	10 300
82	475	109	1 030	136	2 240	163	4 875	190	10 600
83	487	110	1 060	137	2 300	164	5 000	191	10 900
84	500	111	1 090	138	2 360	165	5 150	192	11 200
85	515	112	1 120	139	2 430	166	5 300	193	11 500
86	530	113	1 150	140	2 500	167	5 450	194	11 800
87	545	114	1 180	141	2 575	168	5 600	195	12 150
88	560	115	1 215	142	2 650	169	5 800	196	12 500
89	580	116	1 250	143	2 725	170	6 000	197	12 850
90	600	117	1 285	144	2 800	171	6 150	198	13 200
91	615	118	1 320	145	2 900	172	6 300	199	13 600
92	630	119	1 360	146	3 000	173	6 500	200	14 000
93	650	120	1 400	147	3 075	174	6 700	201	14 500
94	670	121	1 450	148	3 150	175	6 900	202	15 000
95	690	122	1 500	149	3 250	176	7 100	203	15 500
96	710	123	1 550	150	3 350	177	7 300	204	16 000
97	730	124	1 600	151	3 450	178	7 500	205	16 500
98	750	125	1 650	152	3 550	179	7 750	206	17 000
99	775	126	1 700	153	3 650	180	8 000	207	17 500
100	800	127	1 750	154	3 750	181	8 250	208	18 000
101	825	128	1 800	155	3 875	182	8 500	209	18 500
102	850	129	1 850	156	4 000	183	8 750	210	19 000
103	875	130	1 900	157	4 125	184	9 000		
104	900	131	1 950	158	4 250	185	9 250		
105	925	132	2 000	159	4 375	186	9 500		
106	950	133	2 060	160	4 500	187	9 750		



Universal application

## EM-01

TRACTION	=====
SERVICE LIFE	=====
RESISTANCE	=====
RIDING COMFORT	=====
RETREADING	=====



Excellent traction

## EM-02

TRACTION	=====
SERVICE LIFE	=====
RESISTANCE	=====
RIDING COMFORT	=====
RETREADING	=====



# EM radial series

## Ready to move the Earth

Tyre size	EM-01	EM-02
335/80 R 18 (12.5 R 18)		•
365/70 R 18	•	
405/70 R 18 (16/70 R 18)	•	
335/80 R 20 (12.5 R 20)	•	
365/80 R 20 (14.5 R 20)	•	
405/70 R 20 (16/70 R 20)	•	
405/70 R 24 (16/70 R 24)	•	
440/70 R 24 (17.5 L R 24)		•
500/70 R 24 IND	•	

### EM-01

Non-directional tread pattern for **all-round application**

Suitable above all for front loaders, telescopic loaders, backhoe loaders, dumpers and similar vehicles **for light earthmoving work**

**All steel radial** construction

### EM-02

Tread pattern with **good traction** properties

**Excellent durability**

Suitable above all for backhoe loaders, wheeled loaders, telescopic handlers and similar vehicles for **light service**

Also suitable for **agricultural application**



## EM radial series

### Technical data and load capacities

Tyre size	Tread pattern Type	Rim (permitted)	New		Max. in service		Loaded static radius (mm)	Rolling circumference (mm)	Tread depth (mm)	
			Overall diameter (mm)	Section width (mm)	Overall diameter (mm)	Overall width (mm)				
335/80 R 18 (12.5 R 18)	EM-02 TL	11×18	993	339	1 025	354	448	2 990	25	
365/70 R 18	EM-01 TL	11×18 (12×18)	969	360	1 000	400	437	2 915	20	
405/70 R 18 (16/70 R 18)	EM-01 TL	13×18	1 025	407	1 070	452	462	3 085	20	
335/80 R 20 (12.5 R 20)	EM-01 TL	11×20 (12×20)	1 044	339	1 076	366	470	3 140	20	
365/80 R 20 (14.5 R 20)	EM-01 TL	11×20 (12×20)	1 092	360	1 127	400	489	3 285	20	
405/70 R 20 (16/70 R 20)	EM-01 TL	13×20 (11; 12×20)	1 076	407	1 121	452	487	3 240	20	



	Service description LI/SS Transport/ Loading	Tyre load capacity (kg) at speed (km/h)						Tyre pressure (bar)
		0	10	20	30	40	50	
139 B/151 A2		2 526	1 579	1 371	1 254	1 137	1 098	1.4
		3 347	2 092	1 817	1 661	1 505	1 451	2.0
		3 888	2 430	2 102	1 926	1 744	1 684	2.4
		4 659	2 912	2 544	2 319	2 110	2 025	3.0
		5 520	<b>3 450</b>	3 036	2 760	2 540	<b>2 430</b>	<b>3.8</b>
135 B/146 A2		2 395	1 515	1 221	1 177	1 140	1 110	1.5
		2 990	1 885	1 518	1 463	1 415	1 380	2.0
		3 440	2 135	1 689	1 627	1 570	1 535	2.5
		3 970	2 470	1 958	1 887	1 820	1 780	3.0
		4 505	2 795	2 222	2 141	2 070	2 020	3.5
	4 800	<b>3 000</b>	2 398	2 311	2 250	<b>2 180</b>	<b>3.8</b>	
141 B/153 A2		2 745	1 705	1 315	1 267	1 240	1 195	1.5
		3 470	2 165	1 689	1 627	1 580	1 535	2.0
		4 170	2 590	2 019	1 945	1 890	1 835	2.5
		4 850	3 015	2 343	2 258	2 195	2 130	3.0
		5 520	3 430	2 651	2 555	2 490	2 410	3.5
	5 850	<b>3 650</b>	2 833	2 730	2 650	<b>2 575</b>	<b>3.8</b>	
156 B/168 A2		5 935	3 710	2 893	2 788	2 715	2 630	4.0
		6 630	4 150	3 262	3 143	3 055	2 965	4.5
		7 265	4 550	3 575	3 445	3 355	3 250	5.0
		7 840	4 910	3 861	3 721	3 620	3 510	5.5
		8 355	5 225	4 081	3 933	3 830	3 710	6.0
	8 950	<b>5 600</b>	4 400	4 240	4 125	<b>4 000</b>	<b>6.5</b>	
136 B/147 A2		2 370	1 485	1 188	1 145	1 110	1 080	1.5
		2 970	1 815	1 480	1 426	1 390	1 345	2.0
		3 540	2 210	1 766	1 701	1 650	1 605	2.5
		4 100	2 490	2 030	1 956	1 910	1 845	3.0
		4 650	2 880	2 321	2 237	2 170	2 110	3.5
	4 925	<b>3 075</b>	2 464	2 374	2 300	<b>2 240</b>	<b>3.8</b>	
141 B/153 A2		2 750	1 710	1 309	1 261	1 225	1 190	1.5
		3 470	2 185	1 683	1 622	1 575	1 530	2.0
		4 150	2 610	2 002	1 929	1 865	1 820	2.5
		4 840	3 030	2 338	2 253	2 195	2 125	3.0
		5 505	3 440	2 662	2 565	2 480	2 420	3.5
	5 850	<b>3 650</b>	2 833	2 730	2 650	<b>2 575</b>	<b>3.8</b>	
143 B/155 A2		2 905	1 800	1 370	1 320	1 280	1 245	1.5
		3 705	2 325	1 771	1 707	1 650	1 610	2.0
		4 455	2 790	2 129	2 051	1 995	1 935	2.5
		5 165	3 230	2 470	2 380	2 295	2 245	3.0
		5 880	3 670	2 822	2 719	2 635	2 565	3.5
	6 200	<b>3 875</b>	2 998	2 889	2 800	<b>2 725</b>	<b>3.8</b>	

## EM radial series (continued)

### Technical data and load capacities

Tyre size	Tread pattern Type	Rim (permitted)	New		Max. in service		Loaded static radius (mm)	Rolling circumference (mm)	Tread depth (mm)	
			Overall diameter (mm)	Section width (mm)	Overall diameter (mm)	Overall width (mm)				
405/70 R 24 (16/70 R 24)	EM-01 TL	13×24	1 178	407	1 223	452	534	3 545	20	
440/70 R 24 (17.5L R 24)	EM-02 TL	W 15 L×24	1 250	465	1 299	490	563	3 750	38	
500/70 R 24 IND	EM-01	DW16L×24 DW15L×24	1 310	503	1 338	528	585	3 945	28	



EM-01



EM-02



	Service description LI/SS Transport/ Loading	Tyre load capacity (kg) at speed (km/h)						Tyre pressure (bar)
		0	10	20	30	40	50	
146 B/158 A2		3 155	1 945	1 513	1 458	1 410	1 375	1.5
		3 985	2 470	1 909	1 839	1 790	1 735	2.0
		4 835	2 995	2 310	2 226	2 165	2 100	2.5
		5 630	3 500	2 717	2 618	2 535	2 470	3.0
		6 440	3 985	3 102	2 989	2 930	2 820	3.5
		6 800	<b>4 250</b>	3 300	3 180	3 100	<b>3 000</b>	<b>3.8</b>
147 B/164 A2		4 240	2 650	2 488	2 398	2 330	2 262	1.4
		6 480	4 050	2 728	2 629	2 700	2 480	2.0
		7 072	4 420	2 981	2 873	2 950	2 710	2.4
		7 776	4 860	3 267	3 148	3 240	2 970	3.0
		8 032	<b>5 020</b>	3 383	3 260	3 350	<b>3 075</b>	<b>3.2</b>
164 A8/164 B		4 500	2 930	2 750	2 560	2 360	2 360	1.6
		5 500	3 585	3 250	3 025	2 800	2 800	2.0
		6 500	4 240	3 740	3 490	3 240	3 240	2.4
		8 000	5 220	4 500	4 190	3 905	3 905	3.0
		9 500	6 200	5 200	4 885	4 560	4 560	3.6
		10 500	6 850	5 700	5 350	5 000	<b>5 000</b>	<b>4.0</b>



Excellent traction



### EM-20 (NB 38) (L-2)

Tread pattern with excellent traction and self-cleaning properties. Tubeless tyre for construction machinery.



Longer service life



### EM-30 (NB 57) (L-3)

Tread pattern with excellent durability and puncture resistance. Suitable for loaders in hard operating conditions.



Universal application



### EM-60 (L-3)

Tread pattern designed mainly for heavy construction site machines and other machinery operating in combined conditions. Very good self-cleaning properties.



Excellent traction



### EM-70 (E-2/L-2)

Tread pattern with good traction and minimal wheel slip, excellent cushioning, dumping and self-cleaning properties.



Excellent traction



### EM-80 (L-2/G-2)

Excellent traction and self-cleaning performances. Suitable for telescopic handlers, graders and loaders.

# EM diagonal series

## Reliable tyres for demanding earthmoving work

Tyre size	EM-20	EM-30	EM-60	EM-70	EM-80
20-24 (22/70-24)				•	
15.5-25	•	•	•		•
17.5-25	•	•	•		•
20.5-25	•	•	•		
23.5-25		•	•		
26.5-25		•	•		
26.5-29		•			
18.00-25	•	•			

Surface suitability chart – EM series

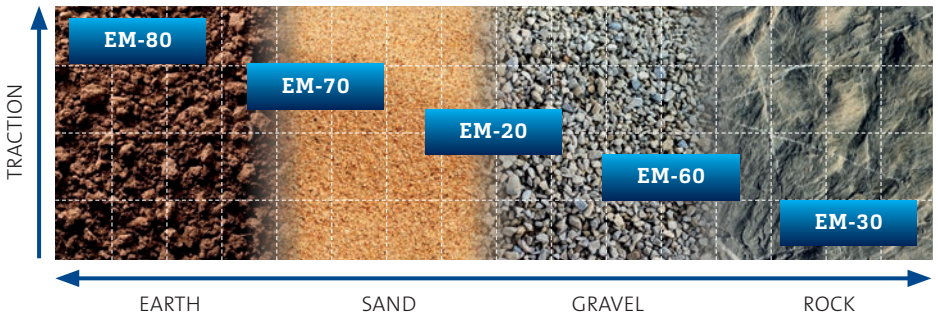

## EM diagonal series

### Technical data and load capacities

Tyre size	Tread pattern Type	Rim (permitted)	New		Max. in service		Loaded static radius (mm)	Rolling circumference (mm)	Tread width (mm)	Tread depth (mm)	
			Overall diameter (mm)	Section width (mm)	Overall diameter (mm)	Overall width (mm)					
20 - 24 (22/70 - 24)	EM-70 TL	16.00 T-24 SDC	1 390	545	1 452	585	633	4 170	460	28.5	
15.5 - 25	EM-20 TL	12.00/1.3-25 (13.00/1.4-25)	1 277	394	1 328	437	590	3 857	325	28	
	NB 57 TL	12.00/1.3-25 (13.00/1.4-25)	1 277	394	1 328	437	590	3 857	325	28	
	EM-60 TL	12.00/1.3-25 (13.00/1.4-25)	1 277	394	1 328	437	590	3 857	355	26	
15.5 - 25	EM-80 TL	12.00/1.3-25	1 277	394	1 328	437	550	3 777	352	25.4	
17.5 - 25	EM-20 TL	14.00/1.5-25	1 348	445	1 405	494	620	4 063	370	30	
	EM-30 TL	14.00/1.5-25	1 348	445	1 405	494	620	4 063	370	30	
	EM-60 TL	14.00/1.5-25	1 348	445	1 405	494	620	4 063	392	28	

Consult the tyre manufacturer for information on other applications of L-2 and L-3 tyres than on wheel loaders, grades, telescopic handlers or dozers.





Tread pattern	Service description LI/SS Loader	Ply rating	Loader service Tyre load capacity (kg) at speed (km/h)			Tyre pressure (bar)
			Static	5	10	
EM-70	173 A2/158 B	12 PR	6 880	4 859	4 300	1.50
			7 520	5 311	4 700	1.75
			8 160	5 763	5 100	2.00
			8 720	6 159	5 450	2.25
			9 280	6 554	5 800	2.50
			9 840	6 950	6 150	2.75
			10 400	7 345	<b>6 500</b>	<b>3.00</b>
			6 800	4 803	4 250	2.50
			7 160	5 057	4 475	2.75
EM-20 NB 57 EM-60	168 A2/149 B	12 PR	7 480	5 283	4 675	3.00
			7 800	5 509	4 875	3.25
			8 160	5 763	5 100	3.50
			8 560	6 046	5 350	3.75
			8 960	6 328	<b>5 600</b>	<b>4.00</b>
			6 800	4 803	4 250	2.50
			7 160	5 057	4 475	2.75
			7 480	5 283	4 675	3.00
			7 800	5 509	4 875	3.25
EM-80	168 A2/142 A8	12 PR	8 160	5 763	5 100	3.50
			8 560	6 046	5 350	3.75
			8 960	6 328	<b>5 600</b>	<b>4.00</b>
			9 256	6 537	5 785	4.25
			9 544	6 740	5 965	4.50
	174 A2/151 A8	16 PR	9 840	6 950	6 150	4.75
			10 136	7 159	6 335	5.00
			10 424	7 362	6 515	5.25
			10 720	7 571	<b>6 700</b>	<b>5.50</b>
EM-20 EM-30 EM-60	177 A2/158 B	16 PR	10 240	7 232	6 400	3.75
			10 640	7 515	6 650	4.00
			11 040	7 797	6 900	4.25
			11 360	8 023	7 100	4.50
			11 680	8 249	<b>7 300</b>	<b>4.75</b>
			14 520	10 255	9 075	6.50
EM-20 EM-60	188 A2/171 B	22 PR	15 280	10 792	9 550	6.75
			16 000	11 300	<b>10 000</b>	<b>7.00</b>

## EM diagonal series (continued)

### Technical data and load capacities

Tyre size	Tread pattern Type	Rim (permitted)	New		Max. in service		Loaded static radius (mm)	Rolling circumference (mm)	Tread width (mm)	Tread depth (mm)
			Overall diameter (mm)	Section width (mm)	Overall diameter (mm)	Overall width (mm)				
17.5 - 25	EM-80 TL	14.00/1.5 - 25	1 348	445	1 405	494	597	4 016	396	27
18.00 - 25*	NB 38 TL	13.00/2.5 - 25 (15.00/2.5 - 25)	1 615	498	1 693	553	734	4 840	404	38
	EM-30 TL	13.00/2.5 - 25 (15.00/2.5 - 25)	1 615	498	1 693	553	734	4 840	404	35
20.5 - 25	EM-20 TL	17.00/2.0 - 25 (17.00/1.7 - 25)	1 492	520	1 561	577	682	4 484	450	38
	EM-30 TL	17.00/2.0 - 25 (17.00/1.7 - 25)	1 492	520	1 561	577	682	4 484	450	38
	EM-60 TL	17.00/2.0 - 25 (17.00/1.7 - 25)	1 492	520	1 561	577	682	4 484	470	32

\* 18.00-25 206A2 40PR EM-30 TL - do not use for container handlers and port application

Consult the tyre manufacturer for information on other applications of L-2 and L-3 tyres than on wheel loaders, graders, telescopic handlers or dozers.



Tread pattern	Service description LI/SS Loader	Ply rating	Loader service Tyre load capacity (kg) at speed (km/h)			Tyre pressure (bar)	
			Static	5	10		
EM-80	171 A2/145 A8	12 PR	7 600	5 368	4 750	2.25	
			8 080	5 707	5 050	2.50	
			8 560	6 046	5 350	2.75	
			8 960	6 328	5 600	3.00	
			9 440	6 667	5 900	3.25	
				9 840	6 950	<b>6 150</b>	<b>3.50</b>
	177 A2/150 A8	16 PR	10 240	7 232	6 400	3.75	
			10 640	7 515	6 650	4.00	
			11 040	7 797	6 900	4.25	
			11 360	8 023	7 100	4.50	
11 680			8 249	<b>7 300</b>	<b>4.75</b>		
NB 38 EM-30			17 280	12 204	10 800	4.25	
			18 400	12 995	11 500	4.75	
			18 880	13 334	11 800	5.00	
			20 000	14 125	12 500	5.50	
			20 480	14 464	12 800	5.75	
	199 A2/180 B	28 PR	20 960	14 803	13 100	6.00	
			21 760	15 368	<b>13 600</b>	<b>6.50</b>	
			22 880	16 159	14 300	7.00	
			24 000	16 950	<b>15 000</b>	<b>7.50</b>	
			25 600	18 080	16 000	8.50	
EM-30	202 A2/183 B	32 PR	26 400	18 645	16 500	9.00	
			27 200	19 210	<b>17 000</b>	<b>9.50</b>	
			206A2/187B	40 PR			
EM-20 EM-30 EM-60	181 A2/167 B	16 PR	8 720	6 159	5 450	1.75	
			9 440	6 667	5 900	2.00	
			10 080	7 119	6 300	2.25	
			10 720	7 571	6 700	2.50	
			11 360	8 023	7 100	2.75	
	186 A2/170 B	20 PR	12 000	8 475	7 500	3.00	
			12 640	8 927	7 900	3.25	
			13 200	9 323	<b>8 250</b>	<b>3.50</b>	
			13 760	9 718	8 600	3.75	
			14 240	10 057	8 900	4.00	
EM-60	189 A2/174 B	24 PR	14 720	10 396	9 200	4.25	
			15 200	10 735	<b>9 500</b>	<b>4.50</b>	
			15 616	11 029	9 760	4.75	
			16 032	11 323	10 020	5.00	
			16 480	11 639	<b>10 300</b>	<b>5.25</b>	

## EM diagonal series (continued)

### Technical data and load capacities

Tyre size	Tread pattern Type	Rim (permitted)	New		Max. in service		Loaded static radius (mm)	Rolling circumference (mm)	Tread width (mm)	Tread depth (mm)
			Overall diameter (mm)	Section width (mm)	Overall diameter (mm)	Overall width (mm)				
23.5 - 25	EM-20 TL	19.50/2.5-25	1 617	597	1 696	663	734	4 843	530	45
	EM-30 TL	19.50/2.5-25	1 617	597	1 696	663	734	4 843	530	40
	EM-60 TL	19.50/2.5-25	1 617	597	1 696	663	734	4 843	540	40
26.5 - 25	EM-30 TL	22.00/3.0-25	1 750	673	1 839	747	791	5 231	605	45
	EM-60 TL	22.00/3.0-25	1 750	673	1 839	747	791	5 231	605	45
26.5 - 29	NB 57 TL	22.00/3.0-29 (24.00/3.0-29)	1 851	673	1 940	747	834	5 525	600	45

Consult the tyre manufacturer for information on other applications of L-2 and L-3 tyres than on wheel loaders, grades, telescopic handlers or dozers.

### Variation in load capacity with speed dependence

Speed (km/h)	0	1	5	10	15	20	25
Load capacity	+60 %	+30 %	+13 %	(0)	-7 %	-12 %	-15 %



Tread pattern	Service description LI/SS Loader	Ply rating	Loader service Tyre load capacity (kg) at speed (km/h)			Tyre pressure (bar)
			Static	5	10	
EM-30 EM-60	186 A2/171 B	16 PR	12 800	9 040	8 000	2.25
			13 600	9 605	8 500	2.50
			14 400	10 170	9 000	2.75
			15 200	10 735	<b>9 500</b>	<b>3.00</b>
EM-20 EM-30 EM-60	191 A2/177 B	20 PR	16 000	11 300	10 000	3.25
			16 800	11 865	10 500	3.50
	199 A2/183 B	28 PR	17 440	12 317	<b>10 900</b>	<b>3.75</b>
			19 600	13 843	12 250	5.00
EM-30 EM-60	203 A2/188 B	28 PR	20 640	14 577	12 900	5.25
			21 760	15 368	<b>13 600</b>	<b>5.50</b>
			20 320	14 351	12 700	3.25
			21 120	14 916	13 200	3.50
			21 760	15 368	13 600	3.75
	206 A2/192 B	32 PR	22 400	15 820	14 000	4.00
			23 200	16 385	14 500	4.25
			24 000	16 950	15 000	4.50
			24 800	17 515	<b>15 500</b>	<b>4.75</b>
			25 600	18 080	16 000	5.00
NB 57	204 A2/189 B	26 PR	26 400	18 645	16 500	5.25
			27 200	19 210	<b>17 000</b>	<b>5.50</b>
			23 200	16 385	14 500	3.75
			24 000	16 950	15 000	4.00
			24 800	17 515	15 500	4.25
			25 600	18 080	<b>16 000</b>	<b>4.50</b>

## Dimensions of "O" rings (mm)

Tyre size	Inside diameter	Section diameter	Circumference
15.5 - 25 17.5 - 25	581±2	6.6±0.5	1 825±6
18.0 - 25 20.5 - 25 23.5 - 25 26.5 - 25	568±2	9.8±0.5	1 784±6
26.5 - 29	655±2	9.8±0.5	2 058±6



Excellent traction



Universal application



### MPT-01

Tread pattern with very good traction and self-cleaning properties. Suitable above all for loader applications.



### MPT-02

Universal tread pattern for various application with good traction and self-cleaning properties.



Universal application



Effective self-cleaning



### MPT-03

Universal tread pattern for on- and off-road application with good traction. Suitable for municipal, on road service, agricultural and other special service vehicles.



### MPT-04

Tread pattern with excellent treadwear and durability. Maximum traction capabilities in soft soil.



Enhanced lateral stability



Excellent traction



### MPT-06

Tread pattern with excellent traction properties and enhanced stability. Especially suitable for telescopic handlers and excavators.



### MPT-08

Robust tread pattern with good traction and perfect stability. Designed especially for excavators and telescopic handlers in hard terrain.



# Light equipment diagonal tyres

## Proven tread patterns for lighter machinery

Tyre size	MPT-01	MPT-02	MPT-03	MPT-04	MPT-06	MPT-08
280/80-18 (10.5-18)	•					
10.5-18		•				
340/80-18 (12.5-18)	•					
18-19.5		•	•		•	•
10.5-20				•		
340/80-20 (12.5-20)	•					
16/70-20 (405/70-20)		•				
405/70-20 (16/70-20)	•					
405/70-24 (16/70-24)	•					
405/70-24				•		



## Light equipment series

### Technical data and load capacities

Tyre size	Tread pattern Type	Rim (permitted)	Tube Flap	New		Max. in service		Loaded static radius (mm)	Rolling circumference (mm)	Tread depth (mm)
				Overall diameter (mm)	Section width (mm)	Overall diameter (mm)	Overall width (mm)			
<b>280/80-18</b> (10.5-18)	MPT-01 TL	9×18	10-18	905	270	927	292	419	2 660	22
<b>10.5-18</b>	MPT-02 TL	9×18	10-18	905	270	927	292	419	2 660	20
<b>340/80-18</b> (12.5-18)	MPT-01 TL	11×18 (9×18)	12.5-18 12-18HS	990	325	1 017	351	455	2 910	25
<b>18-19.5</b>	MPT-02 TL	14.00×19.5 (13.00×19.5)	—	1 080	457	1 121	494	490	3 140	30



	Tread pattern	Service description LI/SS	Ply rating	Tyre load capacity (kg) at speed (km/h)								Tyre pressure (bar)
				Static	10	20	30	40	50	60	65	
MPT-01	130 B			3 271	2 368	1 835	1 687	1 628	1 480			2.25
				3 403	2 464	1 910	1 756	1 694	1 540			2.50
				3 558	2 576	1 996	1 835	1 771	1 610			2.75
				3 757	2 720	2 108	1 938	1 870	1 700			3.00
				3 934	2 848	2 207	2 029	1 958	1 780			3.25
				4 077	2 952	2 288	2 103	2 030	1 845			3.50
	4 199			3 040	2 356	2 166	2 090	<b>1 900</b>			<b>3.75</b>	
	140 B			4 530	3 280	2 540	2 330	2 250	2 050			4.50
				4 860	3 520	2 720	2 500	2 420	2 200			5.00
				5 190	3 760	2 910	2 670	2 580	2 350			5.50
				5 525	4 000	3 100	2 850	2 750	<b>2 500</b>			<b>6.00</b>
				MPT-02	129 D	10 PR	3 525	2 327	1 833	1 622	1 495	1 466
3 700		2 442	1 924				1 702	1 569	1 539	1 495	1 480	2.50
3 900	2 574	2 028	1 794				1 654	1 622	1 576	1 560	2.75	
4 125	2 723	2 145	1 898				1 749	1 716	1 667	1 650	3.00	
4 250	2 805	2 210	1 955				1 802	1 768	1 717	1 700	3.25	
4 450	2 937	2 314	2 047				1 887	1 851	1 798	1 780	3.50	
4 625	3 053	2 405	2 128		1 961		1 924	1 869	<b>1 850</b>	<b>3.75</b>		
MPT-01	132 B	3 337	2 416		1 872		1 721	1 661	1 510			1.75
		3 602	2 608		2 021		1 858	1 793	1 630			2.00
		3 845	2 784		2 158		1 984	1 914	1 740			2.25
	135 B	4 111	2 976		2 306		2 120	2 046	1 860			2.50
		4 287	3 104		2 406		2 212	2 134	1 940			2.75
		4 486	3 248	2 517	2 314	2 233	<b>2 030</b>			<b>3.00</b>		
145 B	4 652	3 368	2 610	2 400	2 316	2 105			3.25			
	4 818	3 488	2 703	2 485	2 398	<b>2 180</b>			<b>3.50</b>			
	5 350	3 875	3 000	2 760	2 660	2 420			4.00			
MPT-02	156 B	16 PR	5 875	4 255	3 300	3 030	2 925	2 660			4.50	
			6 410	4 640	3 595	3 300	3 190	<b>2 900</b>			<b>5.00</b>	
			6 133	4 440	3 441	3 164	3 053	2 775			2.75	
			6 575	4 760	3 689	3 392	3 273	2 975			3.00	
			6 962	5 040	3 906	3 591	3 465	3 150			3.25	
			7 348	5 320	4 123	3 791	3 658	3 325			3.50	
	7 735		5 600	4 340	3 990	3 850	3 500			3.75		
	8 122		5 880	4 557	4 190	4 043	3 675			4.00		
	8 509		6 160	4 774	4 389	4 235	3 850			4.25		
	8 840		6 400	4 960	4 560	4 400	<b>4 000</b>			<b>4.50</b>		

## Light equipment series

### Technical data and load capacities

Tyre size	Tread pattern Type	Rim (permitted)	Tube Flap	New		Max. in service		Loaded static radius (mm)	Rolling circumference (mm)	Tread depth (mm)	
				Overall diameter (mm)	Section width (mm)	Overall diameter (mm)	Overall width (mm)				
<b>18 - 19.5</b>	MPT-03 TL	14.00×19.5 (13.00×19.5)	–	1 080	457	1 121	494	490	3 140	24	
<b>18 - 19.5</b>	MPT-06 TL	14.00×19.5 (13.00×19.5)	–	1 100	470	1 129	505	508	3 280	30	
	MPT-08 TL	14.00×19.5 (13.00×19.5)	–	1 100	470	1 129	505	508	3 280	33	
<b>10.5 - 20</b>	MPT-04 TL	9×20 (9-20SDC)	10.5-20	955	270	977	292	440	2 810	21	
<b>340/80 - 20</b> (12.5 - 20)	MPT-01 TL	11×20 (11;12-20SDC)	–	1 040	325	1 067	351	480	3 060	25	
<b>16/70 - 20</b> (405/70 - 20)	MPT-02 TL	13×20 (13-20SDC)	–	1 076	407	1 116	440	495	3 165	28	



	Tread pattern	Service description LI/SS	Ply rating	Tyre load capacity (kg) at speed (km/h)								Tyre pressure (bar)			
				Static	10	20	30	40	50	60	65				
	MPT-03	156 D	16 PR	6 383	4 579	3 608	3 191	2 942	2 886	2 803	2 775	2.75			
6 843				4 909	3 868	3 421	3 154	3 094	3 005	2 975	3.00				
7 245				5 198	4 095	3 623	3 339	3 276	3 182	3 150	3.25				
7 648				5 486	4 323	3 824	3 525	3 458	3 358	3 325	3.50				
8 050				5 775	4 550	4 025	3 710	3 640	3 535	3 500	3.75				
8 453				6 064	4 778	4 226	3 896	3 822	3 712	3 675	4.00				
8 855				6 353	5 005	4 428	4 081	4 004	3 889	3 850	4.25				
9 200				6 600	5 200	4 600	4 240	4 160	4 040	<b>4 000</b>	<b>4.50</b>				
				MPT-06 MPT-08	160 A8	16 PR	3 720	3 120	2 784	2 640	2 400				1.75
4 108							3 445	3 074	2 915	2 650				2.00	
4 418	3 705	3 306	3 135				2 850				2.25				
4 728	3 965	3 538	3 355				3 050				2.50				
5 038	4 225	3 770	3 575				3 250				2.75				
5 348	4 485	4 002	3 795				3 450				3.00				
5 627	4 719	4 211	3 993				3 630				3.25				
5 890	4 940	4 408	4 180				3 800				3.50				
6 161	5 168	4 611	4 373				3 975				3.75				
6 433	5 395	4 814	4 565				4 150				4.00				
6 704	5 623	5 017	4 758	4 325				4.25							
6 975	5 850	5 220	4 950	<b>4 500</b>				<b>4.50</b>							
	MPT-06	166 A8	-	7 363	6 175	5 510	5 225	4 750				4.75			
7 595				6 370	5 684	5 390	4 900				5.00				
7 905				6 630	5 916	5 610	5 100				5.25				
8 215				6 890	6 148	5 830	<b>5 300</b>				<b>6.00</b>				
	MPT-04	131 D	10 PR	3 312	2 376	1 872	1 656	1 526	1 498	1 454	1 440	2.25			
3 496				2 508	1 976	1 748	1 611	1 581	1 535	1 520	2.50				
3 680				2 640	2 080	1 840	1 696	1 664	1 616	1 600	2.75				
3 864				2 772	2 184	1 932	1 781	1 747	1 697	1 680	3.00				
4 071				2 921	2 301	2 036	1 876	1 841	1 788	1 770	3.25				
4 278				3 069	2 418	2 139	1 972	1 934	1 879	1 860	3.50				
4 485				3 218	2 535	2 243	2 067	2 028	1 970	<b>1 950</b>	<b>3.75</b>				
4 442				3 216	2 492	2 291	2 211	2 010			2.75				
4 619	3 344	2 592	2 383	2 299	<b>2 090</b>			<b>3.00</b>							
	MPT-01	136 B		4 818	3 488	2 703	2 485	2 398	2 180			3.25			
4 995				3 616	2 802	2 576	2 486	<b>2 260</b>			<b>3.50</b>				
				MPT-02	148 D	14 PR	5 359	3 845	3 029	2 680	2 470	2 423	2 353	2 330	2.25
5 739	4 117	3 244	2 869				2 645	2 595	2 520	2 495	2.50				
6 486	4 653	3 666	3 243				2 989	2 933	2 848	2 820	3.00				
6 866	4 925	3 881	3 433				3 164	3 104	3 015	2 985	3.25				
7 245	5 198	4 095	3 623				3 339	3 276	3 182	<b>3 150</b>	<b>3.50</b>				

## Light equipment series

### Technical data and load capacities

Tyre size	Tread pattern Type	Rim (permitted)	Tube Flap	New		Max. in service		Loaded static radius (mm)	Rolling circumference (mm)	Tread depth (mm)
				Overall diameter (mm)	Section width (mm)	Overall diameter (mm)	Overall width (mm)			
<b>405/70 - 20</b> (16/70 - 20)	MPT-01 TL	13×20 (13 - 20SDC)	–	1 076	407	1 116	440	495	3 165	35
<b>405/70 - 24</b> (16/70 - 24)	MPT-01 TL	13×24 (13 - 24SDC)	16/70 - 24	1 178	407	1 218	440	545	3 465	35
<b>405/70 - 24</b>	MPT-04 TL	13×24 (13 - 24SDC)	16/70 - 24	1 178	407	1 218	440	545	3 465	30

### Variation in load capacity with speed dependence

Speed (km/h)	0	10	20	30	40	50	60	65
Tyre speed category	A8	+55%	+30%	+16%	+10%	(0)	–	–
	B	+121%	+60%	+24%	+14%	+10%	(0)	–
	D	+130%	+65%	+30%	+15%	+6%	+4%	+1%



	Tread pattern	Service description LI/SS	Ply rating	Tyre load capacity (kg) at speed (km/h)								Tyre pressure (bar)
				Static	10	20	30	40	50	60	65	
MPT-01	149 B	14 PR	5 304	3 840	2 976	2 736	2 640	2 400			2.25	
			5 691	4 120	3 193	2 936	2 833	2 575			2.50	
			6 431	4 656	3 608	3 317	3 201	2 910			3.00	
			6 807	4 928	3 819	3 511	3 388	3 080			3.25	
			7 183	5 200	4 030	3 705	3 575	<b>3 250</b>			<b>3.50</b>	
			7 514	5 440	4 216	3 876	3 740	3 400			3.75	
MPT-01	152 B	16 PR	7 846	5 680	4 402	4 047	3 905	<b>3 550</b>			<b>4.00</b>	
			7 404	5 360	4 154	3 819	3 685	3 350			3.75	
MPT-01	152 B	14 PR	7 846	5 680	4 402	4 047	3 905	<b>3 550</b>			<b>4.00</b>	
MPT-04	152 B	14 PR	6 115	4 425	3 430	3 155	3 045	2 765			2.00	
			6 325	4 580	3 550	3 260	3 150	2 860			2.50	
			6 510	4 715	3 655	3 360	3 240	2 945			3.00	
			7 020	5 080	3 940	3 620	3 495	3 175			3.50	
			7 935	5 680	4 405	4 050	3 905	<b>3 550</b>			<b>4.00</b>	
			8 840	6 400	4 960	4 560	4 400	<b>4 000</b>			<b>4.50</b>	
	156 B	—	8 840	6 400	4 960	4 560	4 400	<b>4 000</b>			<b>4.50</b>	



Excellent traction



### EM-22

New generation of tyre for excavators. Modified tread pattern NB 38, giving excellent traction and self-cleaning properties. Wider by about 7% in comparison with NB 38. Suitable above all for high power modern excavators.



Designed for rocky terrain



### EM-23

Higher resistance to puncture and tread wear due to higher filling of tread area. Special tread pattern for stony and hard terrain.



Classic design



### NB 38

Classic tread pattern profile for universal application with good traction and self-cleaning properties.



Excellent traction



### NB 38 Extra ML

Wider tread area in comparison with NB 38 by about 23–25%. Better stability due to wider tread area.



Longer service life



### NB 57

Higher resistance to puncture and tread wear due to higher filling of tread area. Tread pattern for stony and hard terrain.



Excellent traction



### TI-12

Tread pattern with excellent traction for flotation tyres, designed above all for powered wheels of agricultural and industrial machines. Applicable for trailed wheels as well.



# Excavator diagonal – wide range of patterns for various conditions

Tyre size	EM-22	EM-23	NB 38	NB 38 Extra ML	NB 57	TI-12
8.25-20			•	•		
9.00-20	•		•	•		
10.00-20	•	•	•	•		
11.00-20	•		•		•	
500/45-20						•
500/60-22.5						•
600/40-22.5						•

## Surface suitability chart – excavator tyres

	Crushed Rock	Gravel	Road	Sand	Loam	Mud
EM-23	■	■	■	■	■	■
NB 57	■	■	■	■	■	■
EM-22	■	■	■	■	■	■
NB 38	■	■	■	■	■	■
NB 38 Extra ML	■	■	■	■	■	■
TI-12	■	■	■	■	■	■

## Variation in load capacity with speed dependence – TI-12

500/45-20, 500/60-22.5, 600/40-22.5

Speed (km/h)	0	10	15	20	25	30	35	40	45	50
Load capacity	+65%	+40%	+33%	+26%	+19%	+12%	+5%	(0)	-5%	-10%



# Excavator

## Technical data and load capacities

Tyre size	Tread pattern Type	Rim (permitted)	Tube Flap	New		Max. in service		Load- ed static radius (mm)	Rolling circum- ference (mm)	Tread width (mm)	
				Overall diameter (mm)	Section width (mm)	Overall diameter (mm)	Overall width (mm)				
8.25 - 20	NB 38 TT	6.5 - 20 (6.0;7.0 - 20)	8.25 - 20 20/1 eHD	970	234	993	253	462	2 940	185	
	NB 38 Extra ML TT	6.5 - 20 (6.0;7.0 - 20)	8.25 - 20 20/1 eHD	970	234	993	253	462	2 940	220	
9.00 - 20	NB 38 TT	7.0 - 20 (6.5;7.5 - 20)	9.00 - 20 20/1 eHD	1 012	256	1 037	276	481	3 070	190	
	NB 38 Extra ML TT	7.0 - 20 (6.5;7.5 - 20)	9.00 - 20 20/1 eHD	1 012	256	1 037	276	481	3 070	234	
	EM-22 TT	7.0 - 20 (6.5;7.5 - 20)	9.00 - 20 20/1 eHD	1 012	256	1 037	276	481	3 070	203	
10.00 - 20	NB 38 TT	7.5 - 20 (7.0;8.0 - 20)	10.00 - 20 20/2 eHD	1 050	275	1 077	297	498	3 180	215	
	NB 38 Extra ML TT	7.5 - 20 (7.0;8.0 - 20)	10.00 - 20 20/2 eHD	1 050	275	1 077	297	498	3 180	264	
	EM-22	7.5 - 20 (7.0;8.0 - 20)	10.00 - 20 20/2 eHD	1 050	275	1 077	297	498	3 180	230	
	EM-23	7.5 - 20 (7.0;8.0 - 20)	10.00 - 20 20/2 eHD	1 050	275	1 077	297	498	3 180	230	
11.00 - 20	NB 38 TT	8.0 - 20 (7.5 - 20)	11.00 - 20 20/2 eHD	1 080	291	1 109	314	511	3 275	240	
	EM-22 TT	8.0 - 20 (7.5 - 20)	11.00 - 20 20/2 eHD	1 080	291	1 109	314	511	3 275	254	
11.00 - 20	NB 57 TT	8.0 - 20 (7.5 - 20)	11.00 - 20 20/2 eHD	1 080	291	1 109	314	511	3 275	-	
500/45 - 20	Tl-12 TL	16.00×20DC	-	980	490	1 030	530	445	2 910	-	
500/60 - 22.5	Tl-12 TL	16.00×22.5DC	-	1 192	503	1 234	543	519	3 504	-	
600/40 - 22.5	Tl-12 TL	20.00×22.5DC	-	1 050	600	1 107	642	473	3 146	-	



	Tread depth (mm)	Minimal dual spacing (mm)	Tread pattern	Service description LI/SS	Ply rating	Tyre load capacity (kg) at speed (km/h)							Tyre pressure (bar)
						Static	10	20	30	40	50	70	
	18	269	NB 38 NB 38 Extra ML	122 B	14 PR	2 825	2 260	1 885	1 542	1 457	1 415	6.00 6.50 <b>6.75</b>	
	18	269				2 910	2 330	1 940	1 586	1 499	1 455		
	20	297	NB 38 NB 38 Extra ML EM-22	140 B	14 PR	4 710	3 770	3 200	2 572	2 431	2 360	6.50 6.75 <b>7.00</b>	
	20	297				4 850	3 880	3 300	2 649	2 503	2 430		
	20	297				5 000	4 000	3 400	2 725	2 575	<b>2 500</b>		
	20	316	NB 38 Extra ML	145 B	14 PR	6 380	4 595	3 830	3 117	2 946	2 860	6.00 <b>6.50</b>	
	22	316	NB 38 NB 38 Extra ML EM-22 EM-23	146 B	16 PR	6 575	4 735	3 945	3 210	3 033	<b>2 945</b>		
	20	316				6 790	4 850	3 880	3 172	2 997	2 910	7.25 <b>7.50</b>	
	18	316				7 000	5 000	4 000	3 270	3 090	<b>3 000</b>		
	25	335	NB 38 EM-22	148 B	16 PR	6 750	4 900	4 042	3 278	3 098	3 008	6.50 7.00 <b>7.25</b>	
	25	335				6 990	5 050	4 180	3 390	3 203	3 110		
	25	335	NB 57	140 E	16 PR	5 450	3 900	3 270	2 725	2 500	2 350	4.00 4.50 <b>5.00</b>	
	25	335				5 850	4 200	3 510	2 925	2 690	2 520		2 340
	32	-	TI-12	160 A8	-	6 250	4 500	3 750	3 125	2 875	2 700	5.20 5.60 <b>6.00</b>	
	32	-				6 831	5 795	5 215	4 640	4 140	3 725		
	35	-	TI-12	152 A8	-	7 128	6 050	5 440	4 840	4 320	3 890	2.80 3.00 3.20 <b>3.60</b>	
	35	-				7 425	6 300	5 670	5 040	<b>4 500</b>	4 050		
	35	-	TI-12	169 A8	-	5 264	4 466	4 019	3 573	3 190	2 871	1.20 1.50 1.80 2.10 2.20 2.50 2.80 4.50 4.80 5.10 5.40 5.70 <b>6.00</b>	
	35	-				5 478	4 648	4 183	3 718	3 320	2 988		
	35	-				5 693	4 830	4 347	3 864	3 450	3 105		
	35	-				5 858	4 970	4 473	3 976	<b>3 550</b>	3 195		
	35	-				3 201	2 715	2 445	2 175	1 940	1 745		
	35	-				3 597	3 050	2 745	2 440	2 180	1 960		
	35	-				3 993	3 390	3 050	2 710	2 420	2 180		
	35	-				4 373	3 710	3 340	2 970	2 650	2 385		
	35	-				4 496	3 815	3 435	3 050	2 725	2 455		
	35	-				4 868	4 130	3 715	3 305	2 950	2 655		
	35	-				5 198	4 410	3 970	3 530	3 150	2 835		
	35	-				8 085	6 860	6 175	5 490	4 900	4 410		
	35	-				8 399	7 125	6 415	5 700	5 090	4 580		
	35	-				8 696	7 380	6 640	5 900	5 270	4 745		
	35	-				8 993	7 630	6 865	6 105	5 450	4 905		
	35	-	9 290	7 880	7 095	6 305	5 630	5 065					
	35	-	9 570	8 120	7 310	6 495	<b>5 800</b>	5 220					



Effective self-cleaning



### COMPACTOR (C-1)

Special tyre for rollers. The same tread pattern for Compactor, Compactor Extra and Compactor Smooth.



### TG-02 (R-4)

Tread pattern with good traction and self-cleaning properties.



Directional stability



### UK 5 (R-3)

Tread pattern suitable for industrial and road construction equipment.



Directional stability



### UK 10 (R-3)

Tread pattern suitable for industrial and road construction equipment.

# Roller & Tractor Grader tyres

## Road works specialists

Tyre size	COMP.	TG-02	UK 5	UK 10
9.5/65 - 15	•			
10.5/80 - 16	•			
11.00-20	•			
11.00 R 20	•			
13/80 R 20	•			
13.00 - 24		•		
14.00 - 24		•		
14.9 - 24 IND			•	
16.9 - 24 IND				•
23.1 - 26 IND			•	•



# Roller & Tractor Grader

## Technical data and load capacities

Tyre size	Tread pattern Type	Rim (permitted)	Tube Flap	New		Max. in service		Loaded static radius (mm)	Rolling circumference (mm)	Minimal dual spacing (mm)
				Overall diameter (mm)	Section width (mm)	Overall diameter (mm)	Overall width (mm)			
9.5/65 - 15	COMPACTOR TL	15 × 7 JA	–	671	243	685	263	333	2 019	280
10.5/80 - 16	COMPACTOR TL	16 × 8 LB	–	812	285	830	307	372	2 430	330
11.00 - 20	COMPACTOR TT	8.0-20 (7.5-20)	11.00-20 20/2 eHD	1 040	290	1 062	314	493	3 150	335
11.00 - 20	COMPACTOR EXTRA TT	8.0-20 (8.5-20)	11.00-20 20/2 eHD	1 064	294	1 086	314	504	3 225	340
11.00 - 20	COMPACTOR SMOOTH TT	8.0-20 (8.5-20)	11.00-20 20/2 eHD	1 070	291	1 092	314	507	3 240	335
11.00 R 20*	COMPACTOR TT	8.0-20	11.00-20 20/2 eHD	1 069	293	1 097	316	–	3 210	352
13/80 R 20*	COMPACTOR TT	9.0-20	13/80-20	1 050	322	1 072	348	–	3 150	387

\* All steel radial construction

COMPACTOR



TG-02



UK 5



UK 10



Service description LI/SS	Ply rating	Tyre load capacity (kg) at speed (km/h)							Tyre pressure (bar)
		Static	5	8	10	15	25		
	6 PR	1 700 1 970 2 100	1 200 1 400 1 500		1 060 1 230 <b>1 315</b>			2.50 3.00 <b>3.25</b>	
	6 PR	2 160 2 600 3 000	1 540 1 850 2 140		1 350 1 620 <b>1 875</b>			2.00 2.50 <b>3.00</b>	
164 A3	16 PR			1 400 2 020 2 640 3 240 3 800 4 350 4 900 5 480 6 000		1 350 1 900 2 480 3 000 3 500 4 000 4 500 <b>5 000</b>		2.00 3.00 4.00 5.00 6.00 7.00 8.00 <b>9.00</b> 10.00	
170 A2	18 PR	7 984 8 272 8 488 8 712 9 000 9 216 9 600			4 990 5 170 5 305 5 445 5 625 5 760 <b>6 000</b>			6.25 6.55 6.90 7.25 7.60 8.00 <b>8.30</b>	
156 A5	18 PR	6 109 6 311 6 468 6 624 7 360			3 818 3 945 4 042 4 140 4 600		3 320 3 430 3 515 3 600 <b>4 000</b>	7.25 7.60 8.00 8.30 <b>10.00</b>	
157 A3	—				1 500 1 900 2 250 2 625 2 950 3 300 3 925 4 550 5 150	1 200 1 525 1 800 2 100 2 375 2 625 3 150 3 650 <b>4 125</b>		1.50 2.00 2.50 3.00 3.50 4.00 5.00 6.00 <b>7.00</b>	
164 A3	—				2 520 3 100 3 660 4 260 4 840 5 420 5 710 6 000	2 240 2 760 3 260 3 790 4 310 4 820 <b>5 000</b>		3.00 4.00 5.00 6.00 7.00 8.00 <b>8.50</b> 9.00	

## Roller & Tractor Grader (continued)

Technical data and load capacities

Tyre size	Tread pattern Type	Rim (permitted)	Tube Flap	New		Max. in service		Loaded static radius (mm)	Rolling circumference (mm)	Tread depth (mm)
				Overall diameter (mm)	Section width (mm)	Overall diameter (mm)	Overall width (mm)			
13.00-24	TG-02 TT/TL	8.00TG SDC (9.00/1.5 (DC))	13.00-24	1 278	333	1 318	360	579	3 770	25
14.00-24	TG-02 TT/TL	8.00TG SDC (10.00 VA SDC)	14.00-24	1 348	362	1 392	391	608	3 975	25

Tyre size	Tread pattern Type	Rim (permitted)	New		Max. in service		Loaded static radius (mm)	Rolling circumference (mm)	Tread depth (mm)
			Overall diameter (mm)	Section width (mm)	Overall diameter (mm)	Overall width (mm)			
14.9-24 IND	UK 5 TL	W 13×24	1 250	395	1 285	425	580	3 710	18
16.9-24 IND	UK 10 TL	W 15 L×24	1 308	442	1 335	464	579	3 729	22
23.1-26 IND	UK 5 TL	DW 20 A×26	1 580	587	1 635	634	750	4 660	20
	UK 10 TL	DW 20 A×26	1 580	587	1 635	634	750	4 660	30



COMPACTOR



TG-02



UK 5



UK 10



	Service description LI/SS	Ply rating	Tyre load capacity (kg) at speed (km/h)					Tyre pressure (bar)
			5	10	15	25	40	
143 A8	12 PR	12 PR	3 502	3 090	2 760	2 287	2 060	2.00
			4 012	3 540	3 162	2 620	2 360	2.50
			4 633	4 088	3 652	3 025	<b>2 725</b>	<b>3.00</b>
153 A8	16 PR	16 PR	5 049	4 455	3 980	3 297	2 970	3.25
			5 653	4 988	4 456	3 691	3 325	3.50
			6 205	5 475	4 891	4 052	<b>3 650</b>	<b>3.75</b>

	Tread pattern	Service description LI/SS	Ply rating	Tyre load capacity (kg) at speed (km/h)							Tyre pressure (bar)
				Static	10	10 cyclic	20	30	40	50	
UK 5	128 A8	8 PR	8 PR	3 265	1 775	2 130	1 935	1 477	1 420	1 292	1.20
				3 565	1 938	2 325	2 112	1 612	1 550	1 411	1.40
				3 865	2 100	2 520	2 289	1 747	1 680	1 529	1.60
				4 140	2 250	2 700	2 453	1 872	<b>1 800</b>	1 638	<b>1.80</b>
UK 10	129 B	8 PR	8 PR	4 140	2 250	2 700	2 160	1 925	1 800	1 640	1.30
				4 395	2 390	2 865	2 350	2 045	1 910	1 738	1.50
				4 635	2 520	3 024	2 480	2 155	2 016	<b>1 850</b>	<b>1.70</b>
UK 5	158 A8	10 PR	10 PR	7 865	4 275	5 130	3 730	3 555	3 420	3 110	1.20
				8 625	4 690	5 625	4 090	3 900	3 750	3 415	1.40
				9 405	5 115	6 135	4 460	4 255	4 090	3 720	1.60
				9 775	5 315	6 375	4 635	4 420	<b>4 250</b>	3 870	<b>1.70</b>
UK 5 UK 10	162 A8	12 PR	12 PR	10 925	5 940	7 125	5 180	4 940	<b>4 750</b>	4 325	<b>1.90</b>



## CR-01

TRACTION	=====
SERVICE LIFE	=====
RESISTANCE	=====
SPEED	=====
COMFORT	=====



## CR-02

TRACTION	=====
SERVICE LIFE	=====
RESISTANCE	=====
SPEED	=====
COMFORT	=====

# CR-01 and CR-02 – new generation of crane tyre for improved productivity

**CR-01** – Open tread block design for excellent traction and easy self-cleaning in off-road application. Deepest tread pattern in category

**CR-02** – High operating economy on the road thanks to lower rolling resistance

**Better performance** due to high maximum speed up to 85 km/h

**Reduced fuel consumption** thanks to all-steel construction improving rolling resistance

**Improved operator comfort** and **low noise emissions** in road high speed service

**Regroovable and suitable for retreading** thanks to high durability of carcass

**Homologated as M + S** and meets requirements for **winter conditions**

**Fully homologated** according to EU Directives 92/93, 2001/43 and 2005/11 (noise homologation)



## CR series

### Technical data and load capacities

Tyre size	Tread pattern Type	Rim (permitted)	New		Max. in service		Loaded static radius (mm)	Rolling circumference (mm)	Tread depth (mm)
			Overall diameter (mm)	Section width (mm)	Overall diameter (mm)	Overall width (mm)			
385/95 R 25	CR-01 TL	9.50/1.7 CR-25 (10.00/1.5-25)	1 369	379	1 415	409	633	4 295	23
445/95 R 25	CR-01 TL	11.00/1.7CR-25 (11.25/2.0-25) (11.00/1.7CR×25)	1 480	440	1 570	483	688	4 504	26
	CR-02 TL	11.00/1.7CR-25 (11.25/2.0-25) (11.00/1.7CR×25)	1 473	440	1 549	475	686	4 506	23
525/80 R 25	CR-01 TL	17.00/1.7CR-25 (17.00/2.0-25)	1 475	530	1 542	588	679	4 450	28

### Dimensions of “O” rings (mm)

Tyre size	Inside diameter	Section diameter	Circumference
385/95 R 25	568 ± 2	9.8 ± 0.5	1 784 ± 6
445/95 R 25			
525/80 R 25			



CR-01

CR-02

Service description LI/SS	Tyre load capacity (kg) at speed (km/h)												Tyre pressure (bar)
	Static	5	10	20	30	40	50	60	70	80	85	90	
170 F	9 750	8 190	7 175	5 850	4 875	4 485	4 370	4 290	4 095	3 900			5.0
	11 250	9 450	8 280	6 750	5 625	5 175	5 040	4 950	4 725	4 500			6.0
	12 500	10 500	9 200	7 500	6 250	5 750	5 600	5 500	5 250	5 000			7.0
	13 750	11 550	10 120	8 250	6 875	6 325	6 160	6 050	5 775	5 500			8.0
	15 000	12 600	11 040	9 000	7 500	6 900	6 720	6 600	6 300	<b>6 000</b>			<b>9.0</b>
174 F	10 395	8 780	7 575	6 360	5 320	4 900	4 775	4 685	4 475	4 260	4 135		5.0
	12 125	10 255	8 855	7 430	6 215	5 720	5 570	5 470	5 220	4 970	4 820		6.0
	13 590	11 465	9 885	8 280	6 915	6 365	6 195	6 075	5 805	5 525	5 360		7.0
	15 160	12 795	11 035	9 255	7 740	7 125	6 940	6 815	6 510	6 195	6 010		8.0
	16 750	14 070	12 060	10 050	8 375	7 705	7 505	7 370	7 035	<b>6 700</b>	6 500		<b>9.0</b>
176 F	13 400	11 250	9 100	8 400	6 700	6 150	6 000	5 900	5 650	5 350		5 050	5.0
	15 400	12 950	10 500	9 250	7 700	7 100	6 900	6 800	6 500	6 150		5 800	6.0
	17 750	14 950	12 100	10 650	8 900	8 200	8 000	7 850	7 500	<b>7 100</b>		6 700	<b>7.0</b>



Longer service life



### MPT-20



Universal perennial tread pattern  
On- and off- road application  
Municipal, military and other special vehicles



Universal application



### MPT-21



Non-directional tread pattern  
Good traction on- and off-the-road  
Effective self-cleaning properties



Excellent traction



### MPT-22 / EM-02



Good traction properties  
Excellent durability  
Also suitable for agricultural application



Longer service life



### MPT-23



Tread pattern for road application  
Low noise emission  
Excellent service life



Rail and road application



### SRT2



Rail & Road application  
Excellent durability  
Longer service life

# Multipurpose radial tyres

## Universal tyres for on- and off-road use

---

Tyre size	MPT-20	MPT-21	MPT-22	MPT-23	EM-02	SRT2
335/80 R 18 (12.5 R 18)					•	
335/80 R 20 (12.5 R 20)	•	•				
365/80 R 20 (14.5 R 20)	•	•				
405/70 R 20 (16/70 R 20)		•				
275/90 R 22.5						•
375/75 R 22.5				•		
405/70 R 24 (16/70 R 24)		•				
445/70 R 24 (17.5 L R 24)			•			





## MPT radial series

### Technical data and load capacities

Tyre size	Tread pattern Type	Rim (permitted)	New		Max. in service		Loaded static radius (mm)	Rolling circumference (mm)	Tread depth (mm)	
			Overall diameter (mm)	Section width (mm)	Overall diameter (mm)	Overall width (mm)				
<b>335/80 R 18</b> (12.5 R 18)	EM-02 TL	11×18 (12×18)	993	340	1 025	354	448	2 979	22	
<b>335/80 R 20</b> (12.5 R 20)	MPT-20 TL	11×20 (12×20)	1 044	340	1 076	354	480	3 132	17.5	
<b>335/80 R 20</b> (12.5 R 20)	MPT-21 TL	11×20 (12×20)	1 044	340	1 076	354	474	3 132	20	
<b>365/80 R 20</b> (14.5 R 20)	MPT-20 TL	11×20 (12×20)	1 092	367	1 128	374	495	3 318	19	
<b>365/80 R 20</b> (14.5 R 20)	MPT-21 TL	11×20 (12×20)	1 092	360	1 128	374	493	3 276	20	
<b>405/70 R 20</b> (16/70 R 20)	MPT-21 TL	13×20 (12×20)	1 076	407	1 110	423	492	3 228	20	



	Service description LI/SS	Tyre load capacity (kg) at speed (km/h)									Tyre pressure (bar)
		Static	10	40	50	70	80	90	100	110	
132G		1 913	1 185	890	850	800	795	765			1.00
		2 738	1 690	1 260	1 205	1 140	1 120	1 095			1.60
		3 250	2 045	1 490	1 440	1 375	1 340	1 300			2.00
		3 763	2 370	1 715	1 670	1 595	1 550	1 505			2.40
		4 463	2 840	2 040	2 000	1 905	1 840	1 785			3.00
		5 000	3 190	2 300	2 240	2 140	2 080	<b>2 000</b>			<b>3.50</b>
147 K		3 300	2 376	1 518	1 478	1 412	1 373	1 346	1 320	1 320	2.00
		4 500	3 240	2 070	2 016	1 926	1 872	1 836	1 800	1 800	3.00
		5 600	4 032	2 576	2 509	2 397	2 330	2 285	2 240	2 240	4.00
		6 563	4 725	3 019	2 940	2 809	2 730	2 678	2 625	2 625	5.00
		7 438	5 355	3 421	3 332	3 183	3 094	3 035	2 975	2 975	6.00
		7 688	5 535	3 536	3 444	3 290	3 198	3 137	3 075	<b>3 075</b>	<b>6.50</b>
139 J		2 430	1 515	1 155	1 142	1 080	1 055	1 030	1 020		1.50
		3 060	1 845	1 445	1 417	1 345	1 313	1 280	1 265		2.00
		3 650	2 260	1 715	1 691	1 600	1 565	1 530	1 510		2.50
		4 215	2 555	1 985	1 943	1 845	1 800	1 755	1 735		3.00
		4 835	3 015	2 300	2 262	2 160	2 103	2 045	2 020		3.50
		5 340	3 330	2 545	2 503	2 380	2 325	2 270	2 235		4.00
	5 850	3 650	2 790	2 722	2 600	2 540	2 480	<b>2 430</b>		<b>4.50</b>	
152 K		3 613	2 510	1 662	1 618	1 546	1 503	1 474	1 395	1 395	2.00
		5 000	3 485	2 300	2 240	2 140	2 080	2 040	2 000	2 000	3.00
		6 438	4 420	2 961	2 884	2 755	2 678	2 627	2 575	2 575	4.00
		7 500	5 375	3 450	3 360	3 210	3 120	3 060	2 970	2 970	5.00
		8 625	6 240	3 968	3 864	3 692	3 588	3 519	3 450	3 450	6.00
		8 875	6 390	4 083	3 976	3 799	3 692	3 621	3 550	<b>3 550</b>	<b>6.25</b>
152 J		2 800	1 745	1 260	1 238	1 185	1 158	1 130	1 105		1.50
		3 525	2 225	1 620	1 607	1 520	1 488	1 455	1 435		2.00
		4 875	3 090	2 255	2 223	2 100	2 058	2 015	1 985		3.00
		6 150	3 790	2 725	2 654	2 530	2 470	2 410	2 370		4.00
		7 450	4 595	3 325	3 265	3 095	3 023	2 950	2 915		5.00
		8 650	5 400	3 930	3 836	3 660	3 573	3 485	3 425		6.00
	8 950	5 600	4 080	3 976	3 800	3 710	3 620	<b>3 550</b>		<b>6.25</b>	
152J		2 780	1 765	1 270	1 249	1 175	1 153	1 130	1 115		1.50
		4 270	2 740	1 980	1 943	1 830	1 798	1 765	1 735		2.50
		5 635	3 600	2 620	2 559	2 430	2 385	2 340	2 285		3.50
		7 030	4 505	3 305	3 254	3 070	3 013	2 955	2 905		4.50
		8 210	5 240	3 815	3 730	3 530	3 465	3 400	3 330		5.50
		8 950	5 600	4 080	3 976	3 800	3 710	3 620	<b>3 550</b>		<b>6.00</b>

## MPT radial series (continued)

### Technical data and load capacities

Tyre size	Tread pattern Type	Rim (permitted)	New		Max. in service		Loaded static radius (mm)	Rolling circumference (mm)	Tread depth (mm)	
			Overall diameter (mm)	Section width (mm)	Overall diameter (mm)	Overall width (mm)				
275/90 R 22.5	SRT2 TL	8.25 × 22.5	1 076	270	1 100	286	491	3 261	17	
375/75 R 22.5*	MPT-23 TL	11.75 × 22.5	1 140	380	1 163	394	521	3 582	25	
405/70 R 24 (16/70 R 24)	MPT-21 TL	13.0 × 24 (13 × 24)	1 178	407	1 212	423	538	3 534	20	
445/70 R 24 (17.5 L R 24)	MPT-22 TL	DW 15 L × 24	1 255	465	1 292	471	573	3 765	38	

\* In preparation, please contact Mitas for availability



Service description LI/SS	Tyre load capacity (kg) at speed (km/h)										Tyre pressure (bar)
	Static	10	40	50	70	80	90	100	110		
153 G/163 A5	6 235	4 570	2 895	2 825	2 670	2 595	2 495				5.50
	6 710	4 905	3 100	3 040	2 875	2 790	2 685				6.00
	7 185	5 240	3 310	3 250	3 075	2 990	2 875				6.50
	7 625	5 590	4 165	3 460	3 200	3 170	3 050				7.00
	8 075	5 935	3 760	3 675	3 455	3 360	3 230				7.50
	8 600	6 250	3 980	3 880	3 680	3 580	3 440				8.00
	9 125	6 570	4 195	4 085	3 905	3 795	<b>3 650</b>				<b>8.50</b>
	165G	5 600	4 030	2 575	2 510	2 400	2 330	2 240			
7 635		5 495	3 510	3 420	3 270	3 175	3 055				4.00
8 785		6 325	4 040	3 935	3 760	3 655	3 515				5.00
10 425		7 505	4 795	4 670	4 460	4 335	4 170				6.00
11 460		8 250	5 270	5 135	4 905	4 765	4 585				7.00
12 875		9 270	5 920	5 765	5 510	5 355	<b>5 150</b>				<b>8.00</b>
152 J	3 225	1 990	1 435	1 378	1 270	1 258	1 245	1 230			1.50
	4 085	2 525	1 820	1 753	1 670	1 628	1 585	1 565			2.00
	4 920	3 035	2 200	2 106	2 020	1 967	1 915	1 880			2.50
	5 750	3 535	2 575	2 486	2 370	2 313	2 255	2 220			3.00
	6 545	4 065	2 940	2 845	2 715	2 650	2 585	2 540			3.50
	7 390	4 555	3 315	3 209	3 055	2 980	2 905	2 865			4.00
	8 165	5 055	3 675	3 573	3 390	3 310	3 230	3 190			4.50
	8 950	5 600	4 080	3 976	3 800	3 710	3 620	<b>3 550</b>			<b>5.00</b>
	151G	3 000	2 150	1 380	1 344	1 284	1 248	1 200			
4 825		3 470	2 220	2 162	2 065	2 007	1 930				2.00
6 625		4 770	3 050	2 968	2 836	2 756	2 650				3.00
7 525		5 430	3 470	3 371	3 221	3 130	3 010				3.50
8 450		6 080	3 880	3 786	3 617	3 515	3 380				4.00
8 625		6 210	3 970	3 864	3 692	3 588	<b>3 450</b>				<b>4.10</b>



Universal application



### MPT-03

Universal tread pattern for on- and off-road application with good traction. Suitable for municipal, on road service, agricultural and other special service vehicles.



Road application



### MPT-05

Universal heavy-duty tread pattern for on- and off-road application. Suitable mainly for municipal, military, on road service and other special service vehicles.



Universal application



### MPT-07

Non-directional tread pattern, suitable for various special service vehicles.

# Multipurpose diagonal

Proven tread patterns  
for wide range of application

---

Tyre size	MPT-03	MPT-05	MPT-07
12.5-18	•		
18-19.5	•		
10.5-20		•	•
12.5-20	•	•	
14.5-20	•	•	
16/70-20		•	
405/70-20	•		



## MPT diagonal series

### Technical data and load capacities

Tyre size	Tread pattern Type	Rim (permitted)	Tube Flap	New		Max. in service		Loaded static radius (mm)	Rolling circumference (mm)	Tread depth (mm)
				Overall diameter (mm)	Section width (mm)	Overall diameter (mm)	Overall width (mm)			
12.5 - 18	MPT-03 TL	11×18 (9×18)	12.5 - 18 12 - 18 HS	990	325	1 017	351	455	2 910	20
10.5 - 20	MPT-05 TL	9×20 (9-20 SDC)	10.5 - 20	955	270	977	292	440	2 810	16
	MPT-07 TT	9×20 (9-20 SDC)	10.5 - 20	955	270	977	292	440	2 810	18
12.5 - 20	MPT-03 TL	11×20 (11; 12-20 SDC)	–	1 040	325	1 067	351	480	3 060	20
12.5 - 20	MPT-05 TL	11×20 (11; 12-20 SDC)	12.5 - 20 (11 - 20)	1 040	325	1 067	351	480	3 060	18
14.5 - 20	MPT-03 TL	11×20 (11; 12-20 SDC)	14.5 - 20 (12.5 - 20)	1 095	355	1 124	383	503	3 220	24
	MPT-05 TL	11×20 (11; 12-20 SDC)	14.5 - 20 (12.5 - 20)	1 095	355	1 124	383	503	3 220	20
16/70 - 20 (405/70 - 20)	MPT-05 TL	13×20 (13-20 SDC)	16 - 20	1 076	407	1 116	440	495	3 165	22
405/70 - 20 (16/70 - 20)	MPT-03 TL	13×20 (13-20 SDC)	–	1 076	407	1 116	440	495	3 165	30

### Variation in load capacity with speed dependence

Speed (km/h)	0	10	20	30	40	50	60	65	70	80	90
Load capacity	+150%	+80%	+50%	+25%	+15%	+12%	+10%	+8.5%	+7%	+4%	(0)

MPT-03



MPT-05



MPT-07



	Tread pattern	Service description L/SS	Ply rating	Tyre load capacity (kg) at speed (km/h)											Tyre pressure (bar)
				Static	10	20	30	40	50	60	65	70	80	90	
MPT-03	128 G	10 PR	3 387	2 439	2 032	1 694	1 558	1 517	1 490	1 470	1 450	1 409	1 355	1.75	
			3 618	2 605	2 171	1 809	1 664	1 621	1 592	1 570	1 548	1 505	1 447	2.00	
			3 871	2 787	2 323	1 935	1 781	1 734	1 703	1 680	1 657	1 610	1 548	2.25	
			4 124	2 970	2 475	2 062	1 897	1 848	1 815	1 790	1 765	1 716	1 650	2.50	
			4 332	3 119	2 599	2 166	1 993	1 941	1 906	1 880	1 854	1 802	1 733	2.75	
	4 500	3 240	2 700	2 250	2 070	2 016	1 980	1 950	1 926	1 872	<b>1 800</b>	<b>3.00</b>			
	4 700	3 384	2 820	2 350	2 162	2 106	2 068	2 040	2 012	1 955	1 880	3.25			
	4 875	3 510	2 925	2 438	2 243	2 184	2 145	2 120	2 087	2 028	<b>1 950</b>	<b>3.50</b>			
	136 G	16 PR	5 055	3 640	3 033	2 528	2 325	2 265	2 224	2 194	2 164	2 103	2 022	3.75	
			5 238	3 771	3 143	2 619	2 409	2 346	2 305	2 273	2 242	2 179	2 095	4.00	
5 420			3 902	3 252	2 710	2 493	2 428	2 385	2 352	2 320	2 255	2 168	4.25		
5 600			4 032	3 360	2 800	2 576	2 509	2 464	2 430	2 397	2 330	<b>2 240</b>	<b>4.50</b>		
3 325			2 394	1 995	1 663	1 530	1 490	1 463	1 443	1 423	1 383	1 330	2.25		
3 500	2 520	2 100	1 750	1 610	1 568	1 540	1 519	1 498	1 456	1 400	2.50				
3 688	2 655	2 213	1 844	1 696	1 652	1 623	1 600	1 578	1 534	1 475	2.75				
3 875	2 790	2 325	1 938	1 783	1 736	1 705	1 682	1 659	1 612	1 550	3.00				
4 088	2 943	2 453	2 044	1 880	1 831	1 799	1 774	1 749	1 700	1 635	3.25				
4 288	3 087	2 573	2 144	1 972	1 921	1 887	1 861	1 835	1 784	1 715	3.50				
4 500	3 240	2 700	2 250	2 070	2 016	1 980	1 953	1 926	1 872	<b>1 800</b>	<b>3.75</b>				
MPT-05 MPT-07	128 G	10 PR	4 513	3 249	2 708	2 256	2 076	2 022	1 986	1 958	1 931	1 877	<b>1 805</b>	<b>3.00</b>	
	129 G	10 PR	4 750	3 420	2 850	2 375	2 185	2 128	2 090	2 062	2 033	1 976	1 900	3.25	
MPT-03	132 G	12 PR	5 000	3 600	3 000	2 500	2 300	2 240	2 200	2 170	2 140	2 080	<b>2 000</b>	<b>3.50</b>	
	4 513	3 249	2 708	2 256	2 076	2 022	1 986	1 958	1 931	1 877	1 805	3.00			
MPT-05	132 G	12 PR	4 750	3 420	2 850	2 375	2 185	2 128	2 090	2 062	2 033	1 976	1 900	3.25	
			5 000	3 600	3 000	2 500	2 300	2 240	2 200	2 170	2 140	2 080	<b>2 000</b>	<b>3.50</b>	
MPT-03 MPT-05	136 G	12 PR	4 088	2 943	2 453	2 044	1 880	1 831	1 799	1 774	1 749	1 700	1 635	1.75	
			4 375	3 150	2 625	2 188	2 013	1 960	1 925	1 899	1 873	1 820	1 750	2.00	
			4 700	3 384	2 820	2 350	2 162	2 106	2 068	2 040	2 012	1 955	1 880	2.25	
			5 000	3 600	3 000	2 500	2 300	2 240	2 200	2 170	2 140	2 080	2 000	2.50	
			5 300	3 816	3 180	2 650	2 438	2 374	2 332	2 300	2 268	2 205	2 120	2.75	
5 600	4 032	3 360	2 800	2 576	2 509	2 464	2 430	2 397	2 330	<b>2 240</b>	<b>3.00</b>				
MPT-05	145 G	14 PR	6 550	4 716	3 930	3 275	3 013	2 934	2 882	2 843	2 803	2 725	2 620	3.00	
			6 888	4 959	4 133	3 444	3 168	3 086	3 031	2 989	2 948	2 865	2 755	3.25	
			7 250	5 220	4 350	3 625	3 335	3 248	3 190	3 147	3 103	3 016	<b>2 900</b>	<b>3.50</b>	
MPT-03	145 G	14 PR	6 550	4 716	3 930	3 275	3 013	2 934	2 882	2 843	2 803	2 725	2 620	3.00	
			6 888	4 959	4 133	3 444	3 168	3 086	3 031	2 989	2 948	2 865	2 755	3.25	
			7 250	5 220	4 350	3 625	3 335	3 248	3 190	3 147	3 103	3 016	<b>2 900</b>	<b>3.50</b>	





# TI series – universal radial tyres for industrial and agricultural application

## TI-20

New generation of tread pattern

Suitable for **construction, road and agricultural work**

**Priority to traction**

Designed for **muddy conditions**

**Very good resistance to damage**

## TI-22

**Good traction and effective self-cleaning properties**

**Excellent durability**

Suitable for backhoe loaders, wheeled loaders, telescopic handlers and similar vehicles for light service

**Also suitable for agricultural application**

Tyre size	TI-20	TI-22
340/80 R 18	•	
460/70 R 24 IND (17.5L R 24)		•
480/80 R 26 IND	•	
440/80 R 28 IND	•	



## TI radial series

### Technical data and load capacities

Tyre size	Tread pattern Type	Rim (permitted)	New		Max. in service		Loaded static radius (mm)	Rolling circumference (mm)	Tread depth (mm)	
			Overall diameter (mm)	Section width (mm)	Overall diameter (mm)	Overall width (mm)				
340/80 R 18 IND	TI-20 TL	11×18 (12×18, W 10×18, W 11×18)	1 001	343	1 023	360	449	2 993	30	
460/70 R 24 IND (17.5L R 24)	TI-22 TL	DW 14 L×24 (DW 15 L, DW 16 L, 14, 16, W 14 L)	1 254	455	1 280	478	559	3 700	38	
480/80 R 26 IND	TI-20 TL	DW 15 L×26 (DW 16 L×26)	1 428	500	1 458	525	640	4 250	34	
440/80 R 28 IND	TI-20 TL	DW 14 L×28 (DW 15 L×28)	1 415	441	1 445	466	640	4 235	34	

### Variation in load capacity with speed dependence

Speed (km/h)	0	5	10	15	20	25	30	35	40	45	50
Constant load	+130%	+45%	+25%	+13%	+9%	+6%	+4%	+2%	(0)	-4%	-9%
Cyclic application	+130%	+67%*	+50%**	+34%	+23%	+11%	+7%	+3%	(0)	-4%	-9%

\* One way distance 150 m.

\*\* One way distance 600 m.



Service description LI/SS	Tyre load capacity (kg) at speed (km/h)							Tyre pressure (bar)
	0	10	10 cyclic	20	30	40	50	
143 A8	3 760	2 045	2 450	1 780	1 700	1 635	1 570	2.0
	4 390	2 390	2 865	2 080	1 985	1 910	1 740	2.5
	5 015	2 725	3 270	2 375	2 270	2 180	1 985	3.0
	5 635	3 060	3 675	2 670	2 550	2 450	2 230	3.5
	6 265	3 405	4 090	2 970	2 835	<b>2 725</b>	2 480	<b>4.0</b>
159 A8	6 010	3 265	3 920	2 845	2 715	2 610	2 375	2.0
	7 020	3 815	4 580	3 330	3 175	3 055	2 780	2.5
	8 035	4 365	5 240	3 805	3 635	3 495	3 180	3.0
	9 050	4 920	5 900	4 290	4 090	3 935	3 580	3.5
	10 065	5 470	6 565	4 770	4 550	<b>4 375</b>	3 980	<b>4.0</b>
160 A8	7 073	3 844	4 613	3 352	3 198	3 075	2 798	2.0
	7 705	4 188	5 025	3 652	3 484	3 350	3 049	2.2
	8 165	4 438	5 325	3 870	3 692	3 550	3 231	2.4
	8 625	4 688	5 625	4 088	3 900	3 750	3 413	2.6
	9 200	5 000	6 000	4 360	4 160	4 000	3 640	2.8
	9 775	5 313	6 375	4 633	4 420	4 250	3 868	3.0
	10 350	5 625	6 750	4 905	4 680	<b>4 500</b>	4 095	<b>3.2</b>
156 A8	6 440	3 500	4 200	3 052	2 912	2 800	2 548	2.0
	6 900	3 750	4 500	3 270	3 120	3 000	2 730	2.2
	7 245	3 938	4 725	3 434	3 276	3 150	2 867	2.4
	7 935	4 313	5 175	3 761	3 588	3 450	3 140	2.6
	8 395	4 563	5 475	3 979	3 796	3 650	3 322	2.8
	8 913	4 844	5 813	4 224	4 030	3 875	3 526	3.0
	9 200	5 000	6 000	4 360	4 160	<b>4 000</b>	3 640	<b>3.2</b>



**TI-02** (R-4)

Classic version of tread pattern for industrial use.



Excellent traction



**TI-05** (R-4)

Robust industrial tread pattern with excellent traction properties.



Excellent traction



**TI-09** (R-4)

Tread pattern with very good traction and self-cleaning properties.



**TG-01** (R-4)

Robust industrial pattern with higher resistance to puncture and tread wear.



**TI-04** (R-4)



Designed for 4x4

Industrial tread pattern for use on backhoe loaders with 4x4 axles.



Longer service life



**TI-06** (R-4)

Robust industrial pattern with higher resistance to puncture and tread wear.



Excellent traction



**GRIP 'N' RIDE** (R-4)

Tread pattern suitable for backhoe loaders and other types of loaders with excellent self-cleaning properties and reinforced sidewall.



Effective self-cleaning



**MPT-04**

Tread pattern with excellent treadwear and durability. Maximum traction capabilities in soft soil.

# Construction applications diagonal

## Robust and durable tyres for construction and road works



Enhanced lateral stability

### MPT-06



Tread pattern with excellent traction properties and enhanced stability. Especially suitable for telescopic handlers and excavators.

### TR-09 (R-4)



Tread pattern with good traction.

Tyre size	TI-02	TI-04	TI-05	TI-06	TI-09	G'n'R	TG-01	MPT-04	MPT-06	TR-09
320/80-18 (12.5/80-18)										•
340/80-18 (12.5-18)								•		
340/80-20 (12.5-20)								•		
360/85-20 (14.5-20)								•		
400/70-20 (16.0/70-20)								•		
400/75-20 (16.0/70-20)										•
480/65-22.5 (18-22.5)									•	
400/70-24								•		
400/80-24 (15.5/80-24)			•							
16.9-24										
16.9-24		•					•			
17.5L-24	•									
460/70-24 (17.5L-24)			•							
19.5L-24			•							
19.5L-24						•				
500/70-24 (19.5L-24)			•							
18.4-26				•						
16.9-28				•						
16.9-28							•			
440/80-30 (16.9-30)					•					

# Construction Applications Diagonal Tyres

## Technical data and load capacities

Tyre size	Tread pattern Type	Rim (permitted)	New		Max. in service		Loaded static radius (mm)	Rolling circumference (mm)	Tread depth (mm)
			Overall diameter (mm)	Section width (mm)	Overall diameter (mm)	Overall width (mm)			
320/80-18 IND (12.5/80-18)	TR-09 TL	11×18 (9×18)	987	308	1 014	323	465	2 900	25
400/75-20 IND (16.0/70-20)	TR-09 TL	13 SDC-20	1 095	408	1 125	450	504	3 220	27

### Variation in load capacity with speed dependence – front tyres

Speed (km/h)		0	10	15	20	25	30	35	40	45	50
Free rolling (40 km/h)	A8 LLV	+ 65%	+ 40%	+ 33%	+ 26%	+ 19%	+ 12%	+ 5%	(0)	- 5%	- 10%
	HLV	+ 98%	+ 68%	+ 60%	+ 51%	+ 43%	+ 34%	+ 26%	+ 20%	+ 14%	+ 8%
Drive wheels (40 km/h)	A8 LLV	+ 135%	+ 40%	+ 33%	+ 26%	+ 19%	+ 12%	+ 5%	(0)	- 5%	- 10%
	HLV	+ 193%	+ 100%	+ 90%	+ 80%	+ 70%	+ 60%	+ 50%	+ 43%	+ 36%	+ 29%

LLV = Low Load Variation

HLV = High Load Variation, is where the tyre load varies by a factor of 2 or more between loaded and unloaded conditions. The inflation pressure for HLV application must be increased, consult tyre manufacturer. In the case of HLV, the maximum distance should not exceed 1 km. For a longer distance, consult tyre manufacturer.

TR-09



Service description LI/SS	Ply rating	Tyre load capacity (kg) - free rolling / drive wheels - at speed (km/h)					Tyre pressure (bar)
		10	20	30	40	50	
138/125 A8	12 PR	2 675/1 890	2 405/1 700	2 140/1 510	1 910/1 350	1 720/1 215	2.50
		2 865/2 015	2 575/1 815	2 290/1 615	2 045/1 440	1 840/1 295	2.80
		3 050/2 170	2 745/1 955	2 440/1 735	2 180/1 550	1 960/1 395	3.10
		3 200/2 235	2 880/2 010	2 560/1 790	2 285/1 595	2 055/1 435	3.40
		3 305/2 310	2 975/2 080	2 650/1 850	<b>2 360/1 650</b>	2 125/1 485	<b>3.70</b>
150/138 A8	14 PR	3 430/2 460	3 090/2 210	2 745/1 965	2 450/1 755	2 205/1 580	2.00
		3 815/2 730	3 435/2 455	3 050/2 185	2 725/1 950	2 450/1 755	2.50
		4 100/3 005	3 690/2 700	3 280/2 400	2 930/2 145	2 640/1 930	3.00
		4 690/3 305	4 220/2 975	3 750/2 645	<b>3 350/2 360</b>	3 015/2 125	<b>3.50</b>



## Construction Applications Diagonal Tyres (continued)

Technical data and load capacities

Tyre size	Tread pattern Type	Rim (permitted)	Tube Flap	New		Max. in service		Loaded static radius (mm)	Rolling circumference (mm)	Tread depth (mm)
				Overall diameter (mm)	Section width (mm)	Overall diameter (mm)	Overall width (mm)			
<b>340/80-18 IND</b> (12.5-18)	MPT-04 TL	11×18 (9×18)	12.5-18 12-18 HS	990	325	1 017	351	455	2 910	25
<b>340/80-20 IND</b> (12.5-20)	MPT-04 TL	11×20 (11;12-20SDC)	12.5-20 (11-20)	1 040	325	1 067	351	480	3 060	22
<b>360/85-20 IND</b> (14.5-20)	MPT-04 TL	11×20 (11;12-20SDC)	14.5-20 (12.5-20)	1 095	355	1 124	383	503	3 220	25
<b>400/70-20 IND</b> (16.0/70-20)	MPT-04 TL	13×20 (13-20SDC)	–	1 076	407	1 116	440	495	3 165	26
<b>480/65-22.5 IND</b> (18-22.5)	MPT-06 TL	14.00×22.5	–	1 166	460	1 197	494	542	3 480	26
<b>400/70-24 IND</b>	MPT-04 TL	13×24 (13-24SDC)	16/70-24	1 178	407	1 218	440	545	3 465	30



MPT-04

MPT-06

	Tread pattern	Service description L/SS	Ply rating	Tyre load capacity (kg) at speed (km/h)								Tyre pressure (bar)
				Static	10	20	30	40	50	60	65	
MPT-04	131 D	10 PR	3 381	2 426	1 911	1 691	1 558	1 529	1 485	1 470	1.75	
			3 611	2 591	2 041	1 806	1 664	1 633	1 586	1 570	2.00	
			3 864	2 772	2 184	1 932	1 781	1 747	1 697	1 680	2.25	
	134 D	12 PR	4 117	2 954	2 327	2 059	1 897	1 862	1 808	1 790	2.50	
			4 324	3 102	2 444	2 162	1 993	1 955	1 899	1 880	2.75	
			4 485	3 218	2 535	2 243	2 067	2 028	1 970	<b>1 950</b>	<b>3.00</b>	
144 D	16 PR	4 692	3 366	2 652	2 346	2 162	2 122	2 060	2 040	3.25		
		4 876	3 498	2 756	2 438	2 247	2 205	2 141	<b>2 120</b>	<b>3.50</b>		
		6 072	4 356	3 432	3 036	2 798	2 746	2 666	2 640	4.50		
MPT-04	132 D	10 PR	6 325	4 538	3 575	3 163	2 915	2 860	2 778	2 750	4.50	
			6 440	4 620	3 640	3 220	2 968	2 912	2 828	<b>2 800</b>	<b>4.75</b>	
			4 439	3 185	2 509	2 220	2 046	2 007	1 949	1 930	2.75	
	135 D	12 PR	4 600	3 300	2 600	2 300	2 120	2 080	2 020	<b>2 000</b>	<b>3.00</b>	
			4 807	3 449	2 717	2 404	2 215	2 174	2 111	2 090	3.25	
			5 014	3 597	2 834	2 507	2 311	2 267	2 202	<b>2 180</b>	<b>3.50</b>	
MPT-04	139 D	12 PR	4 669	3 350	2 639	2 335	2 152	2 111	2 050	2 030	2.25	
			4 991	3 581	2 821	2 496	2 300	2 257	2 192	2 170	2.50	
			5 290	3 795	2 990	2 645	2 438	2 392	2 323	2 300	2.75	
	142 D	14 PR	5 589	4 010	3 159	2 795	2 576	2 527	2 454	<b>2 430</b>	<b>3.00</b>	
			5 842	4 191	3 302	2 921	2 692	2 642	2 565	2 540	3.25	
			6 095	4 373	3 445	3 048	2 809	2 756	2 677	<b>2 650</b>	<b>3.50</b>	
MPT-04	148 D	14 PR	5 359	3 845	3 029	2 680	2 470	2 423	2 353	2 330	2.25	
			5 739	4 117	3 244	2 869	2 645	2 595	2 520	2 495	2.50	
			6 486	4 653	3 666	3 243	2 989	2 933	2 848	2 820	3.00	
	163 A8	16 PR	6 866	4 925	3 881	3 433	3 164	3 104	3 015	2 985	3.25	
			7 245	5 198	4 095	3 623	3 339	3 276	3 182	<b>3 150</b>	<b>3.50</b>	
			4 108	3 445	3 074	2 915	2 650				1.75	
MPT-06	163 A8	16 PR	4 495	3 770	3 364	3 190	2 900				2.00	
			4 844	4 063	3 625	3 438	3 125				2.25	
			5 193	4 355	3 886	3 685	3 350				2.50	
			5 503	4 615	4 118	3 905	3 550				2.75	
			5 813	4 875	4 350	4 125	3 750				3.00	
			6 123	5 135	4 582	4 345	3 950				3.25	
			6 433	5 395	4 814	4 565	4 150				3.50	
			6 704	5 623	5 017	4 758	4 325				3.75	
			6 975	5 850	5 220	4 950	4 500				4.00	
			7 246	6 078	5 423	5 143	4 675				4.25	
			7 518	6 305	5 626	5 335	<b>4 850</b>				<b>4.50</b>	
			6 118	4 389	3 458	3 059	2 820	2 766	2 687	2 660	2.00	
			6 325	4 538	3 575	3 163	2 915	2 860	2 778	2 750	2.50	
			6 509	4 670	3 679	3 255	3 000	2 943	2 858	2 830	3.00	
			7 015	5 033	3 965	3 508	3 233	3 172	3 081	3 050	3.50	
7 935	5 693	4 485	3 968	3 657	3 588	3 485	<b>3 450</b>	<b>4.00</b>				
MPT-04	151 D	14 PR	6 325	4 580	3 550	3 260	3 150	2 860		2.50		
			6 510	4 715	3 655	3 360	3 240	2 945		3.00		
			7 020	5 080	3 940	3 620	3 495	3 175		3.50		
	156 B	-	7 935	5 745	4 455	4 095	3 950	3 590		4.00		
			8 840	6 400	4 960	4 560	4 400	<b>4 000</b>		<b>4.50</b>		

## Construction Applications Diagonal Tyres (continued)

Technical data and load capacities

Tyre size	Tread pattern Type	Rim (permitted)	New		Max. in service		Loaded static radius (mm)	Rolling circumference (mm)	Tread depth (mm)
			Overall diameter (mm)	Section width (mm)	Overall diameter (mm)	Overall width (mm)			
400/80-24 IND (15.5/80-24)	TI-05 TL	DW13×24 (DW14L×24) (13×24, 14×24) (TW14L×24)	1 250	404	1 294	436	573	3 688	35
16.9-24 IND	TI-04 TL	W15L×24 (W14L×24)	1 310	429	1 355	463	610	3 865	27
16.9-24	TG-01 TL	W15L×24 (W14L×24)	1 310	429	1 355	463	579	3 798	25
17.5L-24 IND	TI-02 TL	W15L×24 (W14L×24)	1 241	445	1 278	481	580	3 660	28
460/70-24 IND (17.5L-24)	TI-05 TL	DW14L×24 (DW15L, DW16L, 14, 16, TW14L)	1 250	455	1 300	494	580	3 660	35
19.5L-24 IND	TI-05 TL	DW16L×24	1 314	495	1 356	535	610	3 865	32
	GRIP-n-RIDE TL	W16L×24 (DW16L×24)	1 314	495	1 356	535	610	3 865	27
500/70-24 IND (19.5L-24)	TI-05 TL	DW16L×24 (DW15L×24) (W15L×24) (W16L×24) (16×24)	1 310	503	1 360	528	589	3 865	32



	Tread pattern	Service description L/SS	Ply rating	Tyre load capacity (kg) at speed (km/h)							Tyre pressure (bar)
				Static	10	10 cyclic	20	30	40	50	
	TI-05	162 A8	-	5 975	3 245	3 895	2 830	2 700	2 595	2 365	2.00
				6 800	3 695	4 435	3 220	3 075	2 956	2 690	2.50
				7 625	4 145	4 975	3 615	3 450	3 315	3 020	3.00
				8 450	4 590	5 510	4 005	3 820	3 675	3 340	3.50
				9 275	5 040	6 050	4 395	4 195	4 030	3 670	4.00
				10 100	5 490	6 585	4 785	4 565	4 390	3 995	4.50
				10 925	5 940	7 125	5 180	4 940	<b>4 750</b>	4 325	<b>5.00</b>
	TI-04	149 A8	12 PR	3 795	2 065	2 475	1 800	1 715	1 650	1 500	1.00
				4 335	2 355	2 830	2 055	1 960	1 885	1 715	1.20
				4 875	2 650	3 180	2 310	2 205	2 120	1 930	1.40
				5 395	2 930	3 520	2 555	2 440	2 345	2 135	1.60
				5 865	3 190	3 825	2 780	2 650	2 550	2 320	1.80
				6 360	3 455	4 150	3 015	2 875	2 765	2 515	2.00
				6 900	3 750	4 500	3 270	3 120	3 000	2 730	2.20
	7 190	3 905	4 690	3 405	3 250	3 125	2 845	2.40			
	7 475	4 065	4 875	3 545	3 380	<b>3 250</b>	2 960	<b>2.60</b>			
	TG-01	149 A6	12 PR	6 590	3 580	4 295	3 120	2 980	2 865	2 605	2.30
				6 785	3 685	4 425	3 215	3 070	2 950	2 685	2.40
				6 980	3 795	4 555	3 310	3 160	3 035	2 760	2.50
				7 185	3 905	4 685	3 405	<b>3 250</b>	3 125	2 840	<b>2.60</b>
	TI-02	144 A8	10 PR	4 195	2 500	3 000	2 250	2 000	1 785	1 605	1.10
				4 700	2 800	3 360	2 520	2 240	2 000	1 800	1.30
				5 205	3 100	3 720	2 790	2 480	2 215	1 995	1.50
				5 711	3 400	4 080	3 060	2 720	2 430	2 185	1.70
				6 216	3 705	4 446	3 335	2 960	2 645	2 380	2.00
	6 580	3 920	4 704	3 530	3 135	<b>2 800</b>	2 520	<b>2.20</b>			
	TI-05	159 A8	-	6 555	3 565	4 275	3 105	2 965	2 850	2 595	2.00
				7 430	4 040	4 845	3 520	3 360	3 230	2 940	2.50
				8 305	4 515	5 415	3 935	3 755	3 610	3 285	3.00
				9 175	4 990	5 985	4 350	4 150	3 990	3 630	3.50
	10 065	5 470	6 565	4 770	4 550	<b>4 375</b>	3 980	<b>4.00</b>			
	TI-05 GRIP-n- RIDE	151 A8	12 PR	4 510	2 450	2 940	2 140	2 040	1 960	1 785	1.10
				5 095	2 770	3 325	2 415	2 305	2 215	2 015	1.30
				5 680	3 090	3 705	2 690	2 570	2 470	2 250	1.50
				6 270	3 405	4 090	2 970	2 835	2 725	2 480	1.70
				7 075	3 845	4 615	3 350	3 200	3 075	2 800	1.90
				7 510	4 080	4 900	3 560	3 395	3 265	2 970	2.10
				7 935	4 315	5 175	3 760	3 590	<b>3 450</b>	3 140	<b>2.30</b>
	TI-05	164 A8	-	7 705	4 185	5 022	3 650	3 485	3 350	3 050	2.00
				8 650	4 700	5 640	4 100	3 910	3 760	3 425	2.50
				9 600	5 220	6 260	4 550	4 340	4 175	3 800	3.00
				10 550	5 735	6 880	5 000	4 770	4 585	4 175	3.50
				11 500	6 250	7 500	5 450	5 200	<b>5 000</b>	4 550	<b>4.00</b>

## Construction Applications Diagonal Tyres (continued)

Technical data and load capacities

Tyre size	Tread pattern Type	Rim (permitted)	New		Max. in service		Loaded static radius (mm)	Rolling circumference (mm)	Tread depth (mm)
			Overall diameter (mm)	Section width (mm)	Overall diameter (mm)	Overall width (mm)			
18.4-26 IND	TI-06 TL	W16L×26 (W15L×26)	1 425	467	1 470	504	665	4 190	29
16.9-28 IND	TI-06 TL	W15L×28 (W14L×28)	1 410	429	1 455	463	660	4 160	28
16.9-28	TG-01 TL	W15L×28 (W14L×28)	1 410	429	1 455	463	640	4 190	25
440/80-30 IND (16.9-30)	TI-09 TL	W15L×30 (W14L×30)	1 460	429	1 500	463	685	4 300	34

### Variation in load capacity with speed dependence

Speed (km/h)	0	5	10	15	20	25	30	35	40	45	50
Constant load	+ 130%	+ 45%	+ 25%	+ 13%	+ 9%	+ 6%	+ 4%	+ 2%	(0)	- 4%	- 9%
Cyclic application	+ 130%	+ 67%*	+ 50%**	+ 34%	+ 23%	+ 11%	+ 7%	+ 3%	(0)	- 4%	- 9%

\* One way distance 150 m.

\*\* One way distance 600 m.



	Tread pattern	Service description L/SS	Ply rating	Tyre load capacity (kg) at speed (km/h)							Tyre pressure (bar)			
				Static	10	10 cyclic	20	30	40	50				
	TI-06	156 A8	12 PR	5 200	2 825	3 390	2 465	2 350	2 260	2 055	1.10			
				5 795	3 150	3 780	2 745	2 620	2 520	2 295	1.30			
				6 360	3 455	4 150	3 015	2 875	2 765	2 515	1.50			
				6 900	3 750	4 500	3 270	3 120	3 000	2 730	1.70			
				7 420	4 030	4 840	3 515	3 355	3 225	2 935	1.90			
				7 935	4 315	5 175	3 760	3 590	3 450	3 140	2.10			
				8 570	4 655	5 590	4 060	3 875	3 725	3 390	2.30			
				9 200	5 000	6 000	4 360	4 160	<b>4 000</b>	3 640	<b>2.50</b>			
	TI-06	152 A8	12 PR	4 360	2 370	2 845	2 065	1 970	1 895	1 725	1.10			
				4 970	2 700	3 240	2 355	2 245	2 160	1 965	1.30			
				5 590	3 040	3 645	2 650	2 525	2 430	2 210	1.50			
				6 130	3 330	4 000	2 905	2 770	2 665	2 425	1.70			
				6 670	3 625	4 350	3 160	3 015	2 900	2 640	1.90			
				7 050	3 830	4 600	3 340	3 190	3 065	2 790	2.10			
				7 245	3 940	4 725	3 435	3 275	3 150	2 865	2.20			
				7 705	4 190	5 025	3 650	3 485	3 350	3 050	2.40			
	TG-01	151 A6	12 PR	8 165	4 440	5 325	3 870	3 690	<b>3 550</b>	3 230	<b>2.60</b>			
				7 055	3 834	4 601	3 345	3 195	3 067	2 791	2.30			
				7 253	3 942	4 730	3 440	3 285	3 154	2 870	2.40			
				7 452	4 050	4 860	3 535	3 375	3 240	2 948	2.50			
				7 651	4 158	4 990	3 630	<b>3 465</b>	3 326	3 027	<b>2.60</b>			
				TI-09	154 A8	14 PR	4 740	2 575	3 090	2 245	2 140	2 060	1 870	1.10
							5 245	2 850	3 420	2 485	2 370	2 280	2 070	1.30
							5 750	3 125	3 750	2 725	2 600	2 500	2 275	1.50
	6 325	3 435	4 125				2 995	2 860	2 750	2 500	1.70			
	7 095	3 855	4 625				3 360	3 205	3 085	2 805	2.00			
	7 475	4 060	4 875				3 540	3 380	3 250	2 955	2.20			
	7 995	4 340	5 210				3 785	3 610	3 475	3 160	2.50			
	8 315	4 515	5 420				3 940	3 755	3 615	3 285	2.70			
				8 625	4 685	5 625	4 085	3 900	<b>3 750</b>	3 410	<b>2.90</b>			



Excellent traction

### SK-01

Standard tread pattern with good traction properties and sidewall protection.



Reinforced construction

### SK-02

Heavy duty tread pattern, robust reinforced tread lug in the central part, higher resistance to puncture and tread wear. Reinforced sidewall.



Longer service life

### SK-05

Robust tyre for extreme conditions. Low void ratio and improved depth increases service life. Excellent self-cleaning properties.



Longer service life

### BIG BOY

Robust industrial pattern with higher resistance to puncture and tread wear.



Excellent traction

### TR-10 (R-4)

Tread pattern suitable above all for bigger skid steer loaders and front axles of backhoe loaders or telescopic platforms.



# Skid steer diagonal tyres

For small machines  
with great performance

---

Tyre size	SK-01	SK-02	SK-05	BIG BOY	TR-10
23×8.50-12		•			
27×8.50-15		•			
27×10.50-15		•			
31×15.5-15		•			
10.0/75-15.3 IND	•				
10-16.5		•	•	•	
12-16.5		•	•	•	
14-17.5 IND					•
10.5/80-18				•	
12.5/80-18				•	





## SK series

### Technical data and load capacities

Tyre size	Tread pattern Type	Rim (permitted)	Tube Flap	New		Max. in service		Loaded static radius (mm)	Rolling circumference (mm)	Tread depth (mm)
				Overall diameter (mm)	Section width (mm)	Overall diameter (mm)	Overall width (mm)			
23×8.50-12	SK-02 TL	7.00×12	–	575	214	589	231	258	1 690	13
27×8.50-15	SK-02 TL	7.00×15	–	680	214	695	231	317	2 000	14.5
27×10.50-15	SK-02 TL	8.50×15	–	683	264	693	268	320	2 140	14.5
31×15.5-15	SK-02 TL	13LB×15	–	766	384	800	405	360	2 371	23
10.0/75-15.3 IND	SK-01 TT/TL	9.00×15.3	10-15 HS 10/75-15	780	264	800	277	360	2 295	17



BIG BOY

SK-01

SK-02

SK-05

TR-10

	Tread pattern	Service description LI/SS	Ply rating	Tyre load capacity (kg) at speed (km/h)						Tyre pressure (bar)	
				10	15	20	30	40	50		
	SK-02	99 A4	6 PR	505	470	420	400			1.25	
				550	515	460	435			1.50	
				650	605	540	515			1.75	
				745	695	620	590			2.00	
				840	785	700	665			2.25	
				930	870	<b>775</b>	735			<b>2.50</b>	
		115 A4	10 PR	1 050	980	875	831			2.80	
				1 134	1 058	945	898			3.00	
				1 212	1 131	1 010	960			3.20	
				1 338	1 249	1 115	1 059			3.50	
				1 458	1 361	<b>1 215</b>	1 154			<b>3.80</b>	
						610	570	510	485		1.50
						700	655	585	555		1.75
						790	740	660	625		2.00
	99 A4	6 PR	865	805	720	685			2.25		
			930	870	<b>775</b>	735			<b>2.50</b>		
	SK-02	111 A4	8 PR	990	925	825	780			2.75	
				1 050	985	880	835			3.00	
				1 110	1 040	925	875			3.25	
				1 170	1 095	975	925			3.50	
				1 230	1 150	1 025	970			3.75	
				1 290	1 200	1 070	1 015			4.00	
		1 320	1 235	<b>1 100</b>	1 045			<b>4.20</b>			
		120 A2	8 PR	1 100	850	740	700			3.00	
				1 170	900	790	750			3.25	
				1 240	950	820	800			3.50	
	1 300			1 000	860	850			3.75		
	120 A2	8 PR	1 350	1 050	920	900			4.00		
			<b>1 400</b>	1 110	990	940			<b>4.20</b>		
	SK-02	119 A4	8 PR	1 420	1 190	1 135	1 010			2.50	
				1 535	1 285	1 225	1 090			2.75	
				1 690	1 410	<b>1 350</b>	1 200			<b>3.10</b>	
	SK-01	127 A6	10 PR	1 430	1 355	1 300	1 180			3.00	
				1 505	1 430	1 370	1 245			3.25	
				1 585	1 505	1 440	1 310			3.50	
				1 665	1 580	1 515	1 375			3.75	
				1 745	1 655	1 585	1 440			4.00	
				1 815	1 725	1 650	1 500			4.25	
				1 890	1 800	1 720	1 565			4.50	
				1 970	1 870	1 790	1 625			4.75	
				2 045	1 945	1 860	1 690			5.00	
				2 120	2 015	1 925	<b>1 750</b>			<b>5.25</b>	

## SK series (continued)

### Technical data and load capacities

Tyre size	Tread pattern Type	Rim (permitted)	Tube Flap	New		Max. in service		Loaded static radius (mm)	Rolling circumference (mm)	Tread depth (mm)
				Overall diameter (mm)	Section width (mm)	Overall diameter (mm)	Overall width (mm)			
10-16.5	SK-02 TL	8.25×16.5	–	773	264	792	285	345	2 340	22
	SK-05 TL	8.25×16.5	–	805	259	840	280	366	2 355	35
	BIG BOY TL	8.25×16.5	–	798	259	832	280	366	2 355	19
12-16.5	SK-02 TL	9.75×16.5	–	831	307	851	331	370	2 515	22
	SK-05 TL	9.75×16.5	–	836	305	873	329	384	2 475	35
	BIG BOY TL	9.75×16.5	–	841	315	879	340	384	2 475	20.6
14-17.5 IND	TR-10 TL	10.50×17.5	–	910	355	932	383	430	2 858	22
10.5/80-18	BIG BOY TL	9×18	–	907	274	927	292	411	2 645	26
12.5/80-18	BIG BOY TL	9×18	–	991	307	1 014	323	445	2 865	28



	Tread pattern	Service description LI/SS	Ply rating	Tyre load capacity (kg) at speed (km/h)					Tyre pressure (bar)	
				10	15	20	30	40		50
	SK-02 BIG BOY	131 A3	8 PR	1 640	1 530	1 365	1 195			2.50
				1 730	1 615	1 440	1 265			2.75
	SK-02 SK-05	135 A3	10 PR	1 825	1 700	1 520	1 335			3.00
				1 915	1 785	1 595	1 400			3.25
	SK-02 BIG BOY	140 A3	10 PR	2 005	1 870	1 670	1 465			3.50
				2 090	<b>1 950</b>	1 740	1 525			<b>3.75</b>
	SK-02 SK-05 BIG BOY	144 A3	12 PR	2 100	1 960	1 750	1 540			4.50
				2 215	2 070	1 845	1 645			4.75
	BIG BOY	147 A3	14 PR	2 330	<b>2 180</b>	1 945	1 710			<b>5.00</b>
				2 075	1 935	1 730	1 520			2.50
	SK-02 BIG BOY	140 A3	10 PR	2 210	2 060	1 840	1 615			2.75
				2 330	2 170	1 940	1 700			3.00
	SK-02 SK-05 BIG BOY	144 A3	12 PR	2 440	2 280	2 035	1 785			3.25
				2 525	2 360	2 105	1 845			3.50
	BIG BOY	147 A3	14 PR	2 575	2 400	2 145	1 880			4.00
				2 635	2 450	2 195	1 925			4.25
	BIG BOY	147 A3	14 PR	2 690	<b>2 500</b>	2 240	1 965			<b>4.50</b>
				2 775	2 570	2 310	2 035			4.75
	BIG BOY	147 A3	14 PR	2 860	2 650	2 385	2 100			5.00
				2 960	2 740	2 460	2 165			5.25
	TR-10	139 B	14 PR	3 025	<b>2 800</b>	2 520	2 220			<b>5.50</b>
				3 120	2 890	2 600	2 290			5.75
	BIG BOY	115 A8	10 PR	3 220	2 980	2 680	2 360			6.00
				3 320	<b>3 075</b>	3 010	2 650			<b>6.20</b>
	BIG BOY	128 A8	14 PR	2 760	2 575	2 480	2 205	1 970	1 775	3.20
				2 890	2 700	2 600	2 315	2 065	1 860	3.50
	BIG BOY	128 A8	14 PR	3 030	2 830	2 730	2 425	2 165	1 950	3.80
				3 165	2 950	2 850	2 530	2 260	2 035	4.10
	BIG BOY	128 A8	14 PR	3 345	3 150	3 010	2 675	2 390	2 150	4.50
				3 565	3 320	3 205	2 850	2 545	2 290	5.00
	BIG BOY	128 A8	14 PR	3 780	3 550	3 400	3 025	2 700	<b>2 430</b>	<b>5.50</b>
				1 290		1 160	1 030	920	875	2.80
	BIG BOY	128 A8	14 PR	1 430		1 285	1 145	1 020	970	3.10
				1 560		1 405	1 250	1 115	1 060	3.40
	BIG BOY	128 A8	14 PR	1 700		1 530	1 360	<b>1 215</b>	1 155	<b>3.70</b>
				1 750		1 575	1 400	1 250	1 190	2.50
	BIG BOY	128 A8	14 PR	1 960		1 765	1 570	1 400	1 330	2.80
				2 170		1 955	1 735	1 550	1 475	3.10
	BIG BOY	128 A8	14 PR	2 270		2 040	1 815	1 620	1 540	3.40
				2 350		2 120	1 880	1 680	1 595	3.70
	BIG BOY	128 A8	14 PR	2 435		2 190	1 950	1 740	1 655	4.00
				2 520		2 270	2 015	<b>1 800</b>	1 710	<b>4.30</b>



High durability

## FLR-01

HANDLING	=====
RESISTANCE	=====
SERVICE LIFE	=====

# Material Handling radial tyres

## Heavy-duty all-steel tyres for material handling machinery

---

Designed for fork lifts, container handlers and terminal tractors.

Increased tyre life guaranteed by advanced tread design.

Excellent operator comfort thanks to all-steel construction.

Improved rolling resistance for lower fuel consumption.



# FLR

## Technical data and load capacities

Tyre size	Tread pattern Type	Rim (permitted)	New		Max. in service		Loaded static radius (mm)	Rolling circumference (mm)	Tread pattern depth (mm)	
			Overall diameter (mm)	Section width (mm)	Overall diameter (mm)	Overall width (mm)				
6.00 R 9	FLR-01 TL	4.00E-9	540	160	562	173	–	–	25	
6.50 R 10	FLR-01 TL	5.00F-10	588	177	612	191	–	–	27	
7.00 R 12	FLR-01 TL	5.00S-12	672	192	699	207	–	–	30	
8.25 R 15	FLR-01 TL	6.50-15	836	234	869	253	–	–	35	
12.00 R 20	FLR-01 TL/TT	8.00-20 (8.50 V-20)	1 121	318	1 146	334	505	3 180	36	

For dual application the loads are 88% of single tyre.



Service description LI/SS	Tyre load capacity (kg) at speed (km/h)										Tyre pressure (bar)
	Steering wheel		Load wheel		Side-loaders			Other application			
	25	35	25	35	Static	25	35	10	40		
121 A5	1 090	1 010	1 410	1 360	1 640	1 090	1 010	1 410	960	6.50	
	1 130	1 050	1 470	1 420	1 700	1 130	1 050	1 470	1 000	7.00	
	1 180	1 100	1 540	1 490	1 780	1 180	1 100	1 540	1 050	7.50	
	1 240	1 150	1 620	1 560	1 860	1 240	1 150	1 620	1 110	8.00	
	1 280	1 200	1 680	1 620	1 920	1 280	1 200	1 680	1 140	8.50	
	1 330	1 240	1 750	1 680	1 990	1 330	1 240	1 750	1 200	9.00	
	1 390	1 290	1 820	1 750	2 090	1 390	1 290	1 820	1 230	9.50	
	1 450	1 340	1 880	1 810	2 180	1 450	1 340	1 880	1 280	10.00	
	128 A5	1 290	1 190	1 670	1 620	1 940	1 290	1 190	1 670	1 140	6.00
		1 360	1 250	1 750	1 680	2 040	1 360	1 250	1 750	1 200	6.50
1 410		1 300	1 820	1 752	2 110	1 410	1 300	1 820	1 250	7.00	
1 470		1 360	1 910	1 840	2 200	1 470	1 360	1 910	1 310	7.50	
1 530		1 430	2 010	1 930	2 300	1 530	1 430	2 010	1 370	8.00	
1 580		1 480	2 080	2 010	2 380	1 580	1 480	2 080	1 420	8.50	
1 650		1 540	2 170	2 080	2 470	1 650	1 540	2 170	1 490	9.00	
1 730		1 600	2 250	2 160	2 590	1 730	1 600	2 250	1 530	9.50	
1 800		1 660	2 330	2 240	2 700	1 800	1 660	2 330	1 590	10.00	
136 A5		1 610	1 480	2 080	2 020	2 430	1 610	1 480	2 080	1 430	6.00
	1 690	1 560	2 180	2 100	2 550	1 690	1 560	2 180	1 500	6.50	
	1 750	1 620	2 270	2 190	2 640	1 750	1 620	2 270	1 560	7.00	
	1 830	1 700	2 390	2 300	2 760	1 830	1 700	2 390	1 640	7.50	
	1 910	1 780	2 510	2 410	2 880	1 910	1 780	2 510	1 720	8.00	
	1 970	1 850	2 600	2 510	2 980	1 970	1 850	2 600	1 780	8.50	
	2 050	1 920	2 710	2 600	3 090	2 050	1 920	2 710	1 860	9.00	
	2 150	2 000	2 810	2 700	3 240	2 150	2 000	2 810	1 920	9.50	
	2 240	2 070	2 910	2 800	3 380	2 240	2 070	2 910	1 990	10.00	
	153 A5	2 620	2 410	3 390	3 290	3 950	2 620	2 410	3 390	2 330	6.00
2 750		2 540	3 550	3 420	4 150	2 750	2 540	3 550	2 440	6.50	
2 850		2 640	3 700	3 570	4 300	2 850	2 640	3 700	2 540	7.00	
2 980		2 770	3 890	3 750	4 490	2 980	2 770	3 890	2 670	7.50	
3 110		2 900	4 090	3 920	4 690	3 110	2 900	4 090	2 800	8.00	
3 210		3 010	4 240	4 090	4 850	3 210	3 010	4 240	2 900	8.50	
3 340		3 130	4 410	4 230	5 030	3 340	3 130	4 410	3 030	9.00	
3 500		3 260	4 580	4 400	5 270	3 500	3 260	4 580	3 130	9.50	
3 650		3 370	4 740	4 560	5 500	3 650	3 370	4 740	3 240	10.00	
176 A5		5 100	4 700	6 600	6 400	7 700	5 100	4 700	6 600	4 550	6.00
	5 350	4 950	6 900	6 650	8 080	5 350	4 950	6 900	4 750	6.50	
	5 550	5 150	7 200	6 950	8 390	5 550	5 150	7 200	4 950	7.00	
	5 800	5 400	7 570	7 300	8 760	5 800	5 400	7 570	5 200	7.50	
	6 050	5 650	7 950	7 650	9 150	6 050	5 650	7 950	5 450	8.00	
	6 250	5 880	8 250	7 950	9 450	6 250	5 880	8 250	5 650	8.50	
	6 500	6 100	8 600	8 250	9 820	6 500	6 100	8 600	5 900	9.00	
	6 800	6 350	8 900	8 560	10 270	6 800	6 350	8 900	6 100	9.50	
	7 100	6 570	9 230	8 880	10 730	7 100	6 570	9 230	6 320	10.00	





Longer service life



### FL-01

Tread pattern designed for heavy duty service. Good directional stability.



### FL-02

Rib/block tread pattern combination providing good traction. Good directional control in various service conditions.



Good stability



### FL-03

Rib pattern used in 8" tyres. Good vehicle stability and skid resistance.



Longer service life



### FL-04

Block type tread pattern for heavy duty service in demanding operating conditions. Good traction characteristics and puncture resistance.



### FL-05

Rib tread pattern designed for normal service conditions. Good vehicle stability and skid resistance.



### FL-06

Combination of rib/block tread pattern.

# Material Handling diagonal tyres

## Good handling in various service conditions



**FL-07**

Combination of rib/block tread pattern.



**FL-08**

Higher filling of tread pattern. Tread pattern designed for heavy duty service. Good directional stability



Tyre size	FL-01	FL-02	FL-03	FL-04	FL-05	FL-06	FL-07	FL-08
4.00-8			•					•
5.00-8	•		•					•
16×6-8								•
18×7-8								•
6.00-9	•	•						•
21×8-9								•
6.50-10	•	•						•
23×9-10								•
7.00-12	•	•						•
250/75-12								•
23×5					•		•	
7.50-15								•
8.15-15				•				•
250-15								•
8.25-15						•		•
300-15								•

Counterbalanced lift trucks application		Maximum tyre load capacity (% of reference load)
25 km/h	Load wheel	130
	Steering wheel	100
35 km/h	Load wheel	125
	Steering wheel	92.5

Side-loaders application	Maximum tyre load capacity (% of reference load)
Static	151
25 km/h	100
35 km/h	92.5

Other vehicles application	Maximum tyre load capacity (% of reference load)
10 km/h	130
25 km/h	100
40 km/h	89
50 km/h	84



## FL series

### Technical data and load capacities

Tyre size	Tread pattern	Type	Rim (permitted)	Tube Flap	New		Max. in service		Loaded static radius (mm)	Minimal dual spacing (mm)
					Overall diameter (mm)	Section width (mm)	Overall diameter (mm)	Overall width (mm)		
4.00-8	FL-03	TT	3.00D-8 3 1/4I-8*	4.00-8	414	112	422	121	188	134 138
4.00-8	FL-08	TT	3 1/4I-8	4.00-8	414	112	422	121	188	138
5.00-8	FL-01	TT	3.00D-8	5.00-8	467	132	476	143	208	158
5.00-8	FL-03	TT	3.00D-8	5.00-8	467	132	476	143	208	158
5.00-8	FL-08	TT	3.00D-8	5.00-8	467	132	476	143	208	158
16×6-8	FL-08	TT	4.33R-8	16×6-8	425	152	434	164	192	175
18×7-8	FL-08	TT	4.33R-8	18×7-8	462	173	471	187	206	199
6.00-9	FL-01	TT	4.00E-9	6.00-9	540	160	551	173	240	192
6.00-9	FL-02	TT	4.00E-9	6.00-9	540	160	551	173	240	192
6.00-9	FL-08	TT	4.00E-9	6.00-9	540	160	551	173	240	192
21×8-9	FL-08	TT	6.00E-9	21×8-9	535	200	546	216	234	230
6.50-10	FL-01	TT	5.00F-10 (5.50F-10)	6.50-10	588	177	600	191	262	212 (218)
6.50-10	FL-02	TT	5.00F-10 (5.50F-10)	6.50-10	588	177	600	191	262	212 (218)
6.50-10	FL-08	TT	5.00F-10 (5.50F-10)	6.50-10	588	177	600	191	262	212 (218)
23×9-10	FL-08	TT	6.50F-10	23×9-10	595	225	607	243	260	259
7.00-12	FL-01	TT	5.00S-12	7.00-12	672	192	685	207	303	230
7.00-12	FL-02	TT	5.00S-12	7.00-12	672	192	685	207	303	230
7.00-12	FL-08	TT	5.00S-12	7.00-12	672	192	685	207	303	230
250/75-12 (27×10-12)	FL-08	TT	8.00G-12	250/75-12 27×10-12	681	261	697	274	314	293
23×5	FL-05	TT	3.75P-13	23×5	635	155	654	167	295	186
23×5	FL-07	TT	3.75P-13	23×5	635	155	654	167	290	186
7.50-15	FL-08	TT	6.0-15 (6.5-15)	7.50-15	772	212	787	229	350	254 (260)

\*obligatory for 8 PR and 10 PR



	Tread depth (mm)	Tread pattern	Service description LI/SS	Ply rating	Tyre load capacity (kg)		Tyre pressure (bar)
					Load wheel	Steering wheel	
	6	FL-03	90 A5	6 PR	780	600	8.00
			94 A5	8 PR	870	670	9.00
			97 A5	10 PR	950	730	10.00
	6	FL-08	94 A5	8 PR	870	670	9.00
			97 A5	10 PR	950	730	10.00
	8	FL-01	106 A5	8 PR	1 235	950	8.25
	6	FL-03	106 A5	8 PR	1 235	950	8.25
	11	FL-08	106 A5	8 PR	1 235	950	8.25
			111 A5	10 PR	1 415	1 090	10.00
	12	FL-08	113 A5	16 PR	1 495	1 150	10.00
	14	FL-08	121 A5	14 PR	1 885	1 450	9.00
			125 A5	16 PR	2 145	1 650	10.00
	11.5	FL-01	118 A5	10 PR	1 715	1 320	8.50
			121 A5	12 PR	1 885	1 450	10.00
	10	FL-02	118 A5	10 PR	1 715	1 320	8.50
			121 A5	12 PR	1 885	1 450	10.00
	13	FL-08	118 A5	10 PR	1 715	1 320	8.50
			121 A5	12 PR	1 885	1 450	10.00
	15	FL-08	134 A5	16 PR	2 755	2 120	10.00
	11.5	FL-01	122 A5	10 PR	1 950	1 500	7.75
			125 A5	12 PR	2 145	1 650	9.00
	10	FL-02	122 A5	10 PR	1 950	1 500	7.75
			125 A5	12 PR	2 145	1 650	9.00
	14	FL-08	122 A5	10 PR	1 950	1 500	7.75
			125 A5	12 PR	2 145	1 650	9.00
			128 A5	14 PR	2 340	1 800	10.00
	16	FL-08	142 A5	20 PR	3 440	2 650	10.00
	13	FL-01	133 A5	12 PR	2 680	2 060	8.50
			134 A5	14 PR	2 755	2 120	9.00
	10	FL-02	133 A5	12 PR	2 680	2 060	8.50
			134 A5	14 PR	2 755	2 120	9.00
	15	FL-08	133 A5	12 PR	2 680	2 060	8.50
			134 A5	14 PR	2 755	2 120	9.00
			136 A5	16 PR	2 910	2 240	10.00
	18	FL-08	143 A5	14 PR	3 545	2 725	7.00
			146 A5	16 PR	3 900	3 000	8.00
			152 A5	20 PR	4 615	3 550	10.00
	9.5	FL-05	106 B	6 PR	–	950	6.00
			118 B	10 PR	–	1 320	8.00
	9.5	FL-07	113 A5	6 PR	1 495	1 150	5.25
			121 A5	10 PR	1 885	1 450	8.00
	21	FL-08	144 A5	14 PR	3 640	2 800	9.25
			146 A5	16 PR	3 900	3 000	10.00



## FL series

### Technical data and load capacities

Tyre size	Tread pattern	Type	Rim (permitted)	Tube Flap	New		Max. in service		Loaded static radius (mm)	Minimal dual spacing (mm)
					Overall diameter (mm)	Section width (mm)	Overall diameter (mm)	Overall width (mm)		
8.15 - 15	FL-04	TT	7.0-15	28×9-15	707	216	721	233	322	248
8.15 - 15	FL-08	TT	7.0-15	28×9-15	707	216	721	233	322	248
8.25 - 15	FL-06	TT	6.5-15	8.25-15	836	234	853	253	376	281
8.25 - 15	FL-08	TT	6.5-15	8.25-15	836	234	853	253	376	281
250 - 15	FL-08	TT	7.50-15	250-15	735	250	750	270	340	288
300 - 15 (315/70-15)	FL-08	TT	8.00-15	300-15	840	300	857	324	366	345

<sup>(1)</sup> obligatory for 8 PR and 10 PR



Tread depth (mm)	Tread pattern	Service description LI/SS	Ply rating	Tyre load capacity (kg)		Tyre pressure (bar)
				Load wheel	Steering wheel	
15	FL-04	146 A5	14 PR	3 900	3 000	10.00
18	FL-08	146 A5	14 PR	3 900	3 000	10.00
12	FL-06	149 A5	14 PR	4 225	3 250	8.00
23	FL-08	153 A5	18 PR	4 745	3 650	10.00
20	FL-08	153 A5	18 PR	4 745	3 650	9.50
		155 A5	20 PR	5 040	3 875	10.00
23	FL-08	165 A5	22 PR	6 695	5 150	10.00

## Use & Maintenance

### Storage

- > Keep the tyres clean and away from heat, light, ozone or hydrocarbon sources.
- > Avoid prolonged exposure of the tyres to direct sunlight.
- > Avoid any contact with grease, petrol, volatile solvents or other substances that may deteriorate the rubber.
- > Avoid horizontal storage for tubeless tyres, only small size tyres may be stacked or stored flat (maximum 6 months).
- > When tyres are stored flat (horizontal), the position must be lug against lug.
- > Reduce inflation pressure when tyres are stored fitted on rims.
- > Ensure there is no water or moisture inside the tyre.
- > Never store tyres directly in contact with the ground for long periods.

### Tyre repairs

- > For safety reasons, repairs should only be carried out by specialists using the correct tools.

### Proper use of tyres

- > When loading tyres you have to consider the correlation between speed, inflation pressure and load capacity.
- > Overloading results in premature tyre failure. Use the technical documentation and inflation tables which show the load and pressure figures for different operating speeds.
- > Underinflation results not only in incorrect tread wear but also in ply separation and eventually further damage to the ply.
- > Overinflation makes the tyre stiff and decreases its resistance against hits, leading to ply tear.



Check inflation pressure regularly



Avoid contact with grease, oil and other chemicals



Inspect tyres for damage and irregularities



Observe tyre and vehicle load limits



Read safety and maintenance recommendations



Use only authorised repair

# Fitting and removal instructions

**Demounting and mounting procedures can be dangerous, and should be performed only by trained and qualified staff, using proper tools and procedures. Failure to comply with these procedures may result in faulty positioning of the tyre on the rim, and cause the tyre to burst with explosive force leading to serious physical injury or death.**

## Fitting

1. Make sure that the rim, the tyre and the tube are compatible.
2. Check that the tyre is suitable for the machine. Use only rims recommended or permitted by the tyre manufacturer.
3. Always use the proper specialised equipment and tools.
4. The rim must be clean and in perfect condition (no damage, etc.). If necessary, clean the rim thoroughly with a wire brush. Never fit a tyre onto a rim that shows cracks, significant distortion, evidence of welded repair, etc.
5. Thoroughly inspect the inside as well as the outside of the tyre in order to identify any damage which may be present. If the damage is considered to be beyond repair, the tyre should be scrapped.
6. If fitting with a tube, always use the correct new tube and flap for the tyre size. For fitting tubeless tyres without tubes, on tubeless rims, always use a new tubeless valve.
7. Before fitting, lubricate the rim and the beads. Use only a suitable lubricant that will not damage the tyre (never use silicone or petroleum-based products).
8. We recommend vertical fitting. In case of horizontal fitting it is impossible to see if the lower bead is correctly seated.
9. Fit the tyre on the rim diametrically opposite to the valve hole (respect, if present, the rotation direction indicated by the arrows). With the help of a suitable lever and closely repeated applications, get the first bead over the rim flange. Then pose the lightly inflated talc coated tube (if fitted) inside the tyre. Locate the valve, fitting the ferrule loosely. Fit the second bead, lever it progressively over the rim flange, finish at the valve.
10. For seating the beads and centring of the tyre, remove the valve core. Slowly inflate to ensure correct seating of the beads. Ensure that the beads do not pinch the tube.
11. During tyre inflation keep at a safe distance and always use a safety cage. If possible, fasten the tyre to the wall or use retaining chains. During pressure readings ensure that no part of the body is within the possible trajectory of the valve mechanism or of the caps. It is recommended to use suitable pressure limitation gauges. Use a filter and dehumidifier on the compressed air line to avoid introducing humidity or dirt. Never use a hammer to make a tyre bead seat by hitting it.
12. Continue inflation. Make sure that you do not inflate beyond 2.5 bar if the beads are not well seated and centred on the wheel.
13. If the beads are not correctly seated, deflate, lubricate and inflate again. Repeat these operations until the beads are correctly seated.
14. When all the previous operations have been correctly done refit the valve core. Set the pressure according to the load – see tables in technical databook.
15. Make sure the valves do not touch the rims, the brake drums or other fixed mechanical parts.

## Removing

- > Never try to unseat the beads of an inflated tyre.
- > Always remove the valve core.
- > Let the tyre deflate, check before unseating that the tyre is completely deflated. Never use tools that could damage the rims or the beads of the tyre.



# Earthmover tyres

## “L” series type tyres

“L” series type tyres are used on all size loaders and dozers in off-road applications. Most loader type tyres, because of their extremely heavy construction, are limited to very low speeds and very short haul distances, 10 km/h and 250 m maximum.

### Wheeled Loader



### Wheeled Dozer



**Loader Service:** Closed working cycle  
 Low speed – up to 10 km/h  
 Short distance – up to 250 m

**Dozer Service:** Pushes or grades material  
 Low speed – up to 10 km/h  
 Travel distance varies

**Load and Carry Service:** Picks up and transports material  
 Low speed – up to 25 km/h  
 Short distance – cycle length up to 600 m

“L” series tyres are categorized by **number code**, **type** and **tread depth**.

Number code	Type	Tread depth
L-2	Traction Design	Regular Tread Depth
L-3	Rock Design	Regular Tread Depth

Below are examples of Mitas “L” Series tyres



The letter designation and number code is found on the sidewalls of tyres.  
 The **L-2** traction design tyre gives maximum traction in sand and soft soil conditions.  
 The **L-3** rock design offers good traction and rock resistance in general purpose loader operations.

These illustrations show different lug to void ratios.

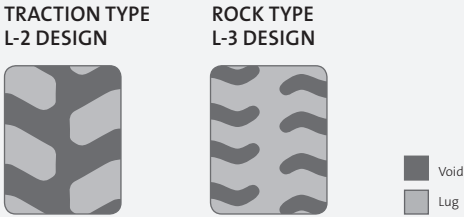

MITAS has also developed comparison ratings for “L” series type tyres.

Note: The numbers are relative ratings with the L-3 tyre rated at 100. For example, the L-2 tyre has 20% better traction than the L-3. Certain tyre construction features and applications can affect these ratings.

The data below could vary from operation and /or from size to size of tyre.

“L” series tyres				
	Traction	Rock resistance	Tread wear	Lug to Void ratio
L-2	120	90	90	1 : 1
L-3	100	100	100	1 : 2

## Determining Inflation Pressures for Loaders

### 1 – By weighing the machine axle

- Determine the maximum load on each tyre by weighing, this is the only way of setting tyre pressures accurately for optimum performance
- Use the table “Variation in load capacity with speed” for LOADERS to determine the pressure  
Front axle: for laden front axle (bucket full)  
Rear axle: for unladen rear axle (bucket empty)

### 2 – By calculation, using the machine manufacturer’s data

When the machine is loading with the bucket penetrating into the material, the loader is often on the point of tipping.

It is in this state that the front tyres are most heavily laden.

- Determine the maximum load /tyre on the front and rear axles

#### FRONT axle

The load on the front axle is equal to the total unladen weight of the machine + the tipping load (tipping load is shown in machine manufacturer’s data).

#### REAR axle (bucket empty)

- Use either the unladen rear axle load given by the machine manufacturer, or
- Take 60% of the unladen weight of the machine (to have a margin of safety)

## Earthmover tyres (continued)

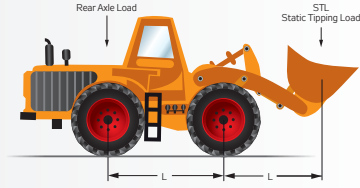

Example calculation (for a loader with the following characteristics):

Tyre equipment:	23.5 - 25 16 PR EM-30 TL		
Unladen weights:	Front:	8 000 kg (1)	
	Rear:	8 500 kg (2)	
	Total:	16 500 kg (3)	
Straight line tipping load:		13 900 kg (4)	

Maximum axle load – Front (static\*)  
 (3) + (4) = 30 400 kg or 15 200 kg per tyre

Maximum axle load – Rear  
 (2) = 8 500 kg or 4 250 kg per tyre

Base pressures as per table “Variation in load capacity with speed”  
 Front = 300 kPa (\* increase for static load from 10 km/h is 60 %, 15 200 / 1.6 = 9 500 kg)  
 Rear = 250 kPa (calculated with a margin of safety for speed 25 km/h)

### Important

The rule to determine pressures by calculation applies to loaders of standard specifications, which have not been modified for special use. The calculated pressures are the minimum for the loads and may be increased to obtain a desired level of handling, or for particular applications, (but must remain within the published load / pressure schedule for the tyre size and type). In the case of long travel distances (e.g. delivery of new machine, transfer from one site to another, etc.), specific precautions need to be taken:

#### Vehicles in Transit

- Vehicles must be empty during transit
- Set inflation pressure on cold tyres to the maximum value permitted by the table “Variation in load capacity with speed” for loaders
- Maximum vehicle speed 35 km/h
- Cooling stop 30 minutes after each 50 km transit
- Transit to a distance longer than 100 km is not recommended and the vehicle must be transported on a trailer

**The inflation pressure will increase during roading of the vehicles. The pressure must not be lowered when tyres are warm.**

#### Determining Inflation Pressures for Dozers:

Depending on the type of work, tyres on a dozer are subjected to different types of loading.

- The load on the Front Axle is maximum when loading (pushing) a scraper
- The load on the Rear Axle is maximum when dozing or whilst stockpiling

From a practical viewpoint, the maximum load on either of the two axles is approximately equal to 2/3 of the machine weight.

- Using this method determine the load on each tyre
- Use the table “Variation in load capacity with speed”

#### Determining Inflation Pressures for Telescopic Handlers

In the case of telescopic handlers the pressures recommended by the machine manufacturer should be used. These pressures are determined by the machine manufacturer after conducting a “Tilt Test” for stability. In the absence of the machine manufacturer’s recommendation, use the pressure corresponding to the maximum normalised load as shown in the table “Variation in load capacity with speed” for LOADERS for both front and rear tyres.

# List of homologations

Inch	Tyre size	Alternative tyre size	Tread pattern	DOT 119	ECE R.54	M + S	ECE R.106	ECE R.117	EC 2001/43
<b>EM Diagonal Tyres</b>									
20"	500/45-20		TI-12				•		
22.5"	500/60-22.5		TI-12				•		
	600/40-22.5		TI-12				•		
<b>Light Equipment Diagonal Tyres</b>									
18"	280/80-18	(10.5-18)	MPT-01				•		
	10.5-18		MPT-02				•		
	340/80-18	(12.5-18)	MPT-01				•		
19.5"	18-19.5		MPT-02						
	18-19.5		MPT-03						•
	18-19.5		MPT-06						
	18-19.5		MPT-08						
20"	10.5-20		MPT-04						
	340/80-20	(12.5-20)	MPT-01				•		
	16/70-20	(405/70-20)	MPT-02				•		
	405/70-20	(16/70-20)	MPT-01						•
24"	405/70-24	(16/70-24)	MPT-01				•		
	405/70-24		MPT-04						
<b>Crane Radial Tyres</b>									
25"	385/95 R 25		CR-01	•	•	•			
	445/95 R 25		CR-01	•	•	•			
	445/95 R 25		CR-02	•	•				
	525/80 R 25		CR-01	•	•	•			
<b>MPT Radial Tyres</b>									
18"	335/80 R 18	(12.5 R 18)	EM-02	•	•				•
20"	335/80 R 20	(12.5 R 20)	MPT-20	•	•	•			•
	335/80 R 20	(12.5 R 20)	MPT-21	•	•	•			•
	365/80 R 20	(14.5 R 20)	MPT-20	•	•	•			•
	365/80 R 20	(14.5 R 20)	MPT-21	•	•	•			•
	405/70 R 20	(16/70 R 20)	MPT-21	•	•	•			•
22.5"	275/90 R 22.5		SRT2	•	•	•	•		•
	375/75 R 22.5		MPT-23	•	•				•
24"	405/70 R 24	(16/70 R 24)	MPT-21	•	•	•			•
	445/70 R 24	(17.5L R 24)	MPT-22	•					•

Inch	Tyre size	Alternative tyre size	Tread pattern	DOT 119	ECE R.54	M + S	ECE R.106	ECE R.117	EC 2001/43
<b>MPT Diagonal Tyres</b>									
18"	12.5-18		MPT-03				•	•	•
20"	10.5-20		MPT-05				•	•	•
	10.5-20		MPT-07	•	•	•			•
	12.5-20		MPT-03				•	•	•
	12.5-20		MPT-05				•	•	•
	14.5-20		MPT-03				•	•	•
	14.5-20		MPT-05				•	•	•
	16/70-20	(405/70-20)	MPT-05				•	•	•
	405/70-20	(16/70-20)	MPT-03				•	•	•
<b>Tractor Industrial Radial Tyres</b>									
18"	340/80 R 18 IND		TI-20				•		
24"	460/70 R 24 IND	(17.5L R 24)	TI-22				•		
26"	480/80 R 26 IND		TI-20				•		
28"	440/80 R 28 IND		TI-20				•		
<b>Construction Applications Diagonal Tyres</b>									
18"	320/80-18 IND	(12.5/80-18)	TR-09				•		
	340/80-18 IND	(12.5-18)	MPT-04				•		
20"	340/80-20 IND	(12.5-20)	MPT-04				•		
	360/85-20 IND	(14.5-20)	MPT-04				•		
	400/70-20 IND	(16.0/70-20)	MPT-04				•		
	400/75-20 IND	(16.0/70-20)	TR-09				•		
22.5"	480/65-22.5 IND	(18-22.5)	MPT-06				•		
24"	400/70-24 IND		MPT-04				•		
	400/80-24 IND	(15.5/80-24)	TI-05				•		
	16.9-24 IND		TI-04				•		
	16.9-24		TG-01				•		
	17.5L-24 IND		TI-02				•		
	460/70-24 IND	(17.5L-24)	TI-05				•		
	19.5L-24 IND		TI-05				•		
	19.5L-24 IND	GRIP-n-RIDE					•		
	500/70-24 IND	(19.5L-24)	TI-05				•		
26"	18.4-26 IND		TI-06				•		
28"	16.9-28 IND		TI-06				•		
	16.9-28		TG-01				•		
30"	440/80-30 IND	(16.9-30)	TI-09				•		

- DOT 119 Nat'l Highway Traffic Safety Admin., DOT § 571.119 Standard No. 119; New pneumatic tyres for motor vehicles with a GVWR of more than 4 536 kilograms (10 000 pounds) and motorcycles.
- ECE R.54 European Regulation No. 54; Uniform provisions concerning the approval of pneumatictyres for commercial vehicles and their trailers.
- M + S Mud & Snow Pattern
- ECE R.106 European Regulation No. 106; Uniform provisions concerning the approval of pneumatictyres for agricultural vehicles and their trailers.
- ECE R.117 European Regulation No. 117; Uniform provisions concerning the approval of tyres with regard to rolling sound emissions and to adhesion on wet surfaces and/or to rolling resistance.
- EC 2001/43 European Directive 2001/43/EC relating to tyres for motor vehicles and their trailers and to their fitting; noise from tyres.

# Rim specification

## Sample of rim marking

DW18Lx38	Meaning
DW	Rim Contour
18	Nominal Rim Width in inches
L	Flange Height code
x	One-piece rim
38	Nominal Rim Diameter in inches

## Further samples of marking

	Meaning
W	Wide Drop Centre – Single Well shape rim
DW	Wide Drop Centre – Double Well shape rim
SDC	Semi-drop Centre rim
–	Multi-piece rim
x	One-piece rim
H2	Double Hump
DC	Drop Centre rim

## 5° Drop Centre rims

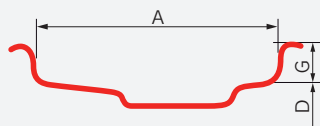

RIM	A	G	D
9.00×15.3	228.6	19.0	388.8
9×18	228.6	25.4	462.0
11×18	279.4	25.4	462.0
12×18	304.8	25.4	462.0
13×18	330.2	25.4	462.0
9×20	228.6	25.4	512.8
11×20	279.4	25.4	512.8
12×20	304.8	25.4	512.8
13×20	330.2	25.4	512.8
16.0×20	406.5	25.5	512.8
13×24	330.2	25.4	614.4
13.0×24	330.2	25.4	614.4

## 15° Drop-centre rims

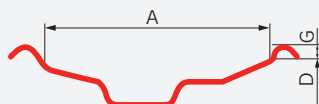

RIM	A	G	D
8.25×16.5	209.6	12.7	419.1
9.75×16.5	247.6	12.7	419.1
10.50×17.5	266.5	12.7	444.5
13.00×19.5	330.2	12.7	495.3
8.25×22.5	209.5	12.7	571.5
11.75×22.5	298.5	12.7	571.5
14.00×19.5	355.6	12.7	495.3
16.00×22.5	406.4	12.7	571.5
20.00×22.5	508.0	12.7	571.5

## 5° Full Tapered Rims

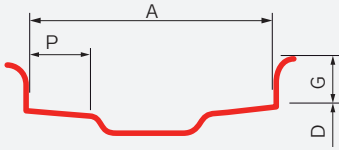

RIM	A	G	D
11.25/2.0 - 25	286.0	51.0	635.0
13.00/2.5 - 25	330.2	63.5	635.0
15.00/2.5 - 25	381.0	63.5	635.0
17.00/2.0 - 25	431.8	50.8	635.0
19.50/2.5 - 25	495.3	63.5	635.0
22.00/3.0 - 25	558.8	76.2	635.0
24.00/3.0 - 25	609.6	76.2	635.0
25.00/3.5 - 25	635.0	89.0	635.0
22.00/3.0 - 29	558.8	76.2	736.6
24.00/3.0 - 29	609.6	76.2	736.6
13.00/2.5 - 33	330.2	63.5	838.2

## 5° Tapered rims

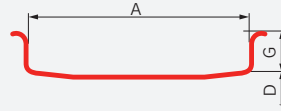

RIM	A	G	D
6.0 - 15	152.4	33.0	387.4
6.5 - 15	165.1	35.6	387.4
7.0 - 15	177.8	38.1	387.4
6.0 - 20	152.4	33.0	514.4
6.5 - 20	165.1	35.6	514.4
7.0 - 20	177.8	38.1	514.4
7.5 - 20	190.5	40.6	514.4
8.0 - 20	203.2	43.2	514.4
8.5 - 20	215.9	45.7	514.4
9.0 - 20	228.5	48.5	514.4

## 5° Full Tapered rims

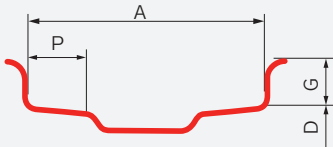

RIM	A	G	D
9.50/1.7 CR - 25	241.5	43.0	635.0
10.00/1.5 - 25	254.0	38.1	635.0
11.00/1.7 CR - 25	279.5	43.0	635.0
12.00/1.3 - 25	304.8	33.0	635.0
14.00/1.5 - 25	355.6	38.1	635.0
17.00/1.7 - 25	431.8	43.2	635.0

## 5° Semi-Drop Centre Rims

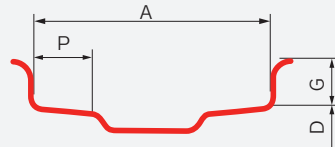

RIM	A	G	D
9×20 SDC	228.6	25.4	512.8
11×20 SDC	279.4	25.4	512.8
12×20 SDC	304.8	25.4	512.8
13×20 SDC	330.2	25.4	512.8
13×24 SDC	330.2	25.4	614.4
8.00 TG×24 SDC	203.2	35.7	614.4
16.00 T-24 SDC	406.4	35.7	614.4
10.00 VA×24 SDC	254.0	43.2	614.4

## Rim specification (continued)

### 5° Drop Centre rims

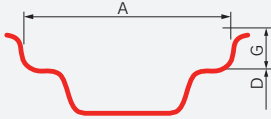

RIM	A	G	D
7.00×12	177.8	20.5	304.0
7.00×15	177.8	20.5	380.2
7 JA×15	177.8	16.0	380.2
8 J×15	203.0	17.3	380.2
8.50×15	216.0	17.3	380.2
13 LB×15	330.0	22.0	380.2
8 LB×16	203.0	22.0	405.6

### 5° Tapered rims

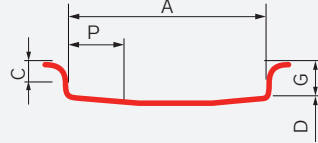

RIM	A	G	D
3.00 D-8	76.2	17.5	202.4
4.00 E-9	101.6	19.8	227.8
6.00 E-9	152.4	19.8	227.8
5.00 F-10	127.0	22.2	253.2
5.50 F-10	139.7	22.2	253.2
6.50 F-10	165.1	22.2	253.2
5.00 S-12	127.0	31.3	308.8
8.00 G-12	203.2	27.9	304.0

### 5° Drop-Centre rims

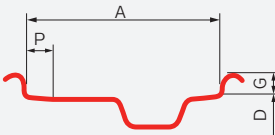

RIM	A	G	D
9.00/1.5-24	228.6	38.0	614.4
13.00/1.4-25	330.2	35.8	635.0
14.00/1.3-25	355.6	33.0	635.0

### 5° Tapered rims – Divided Type

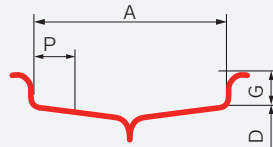

RIM	A	G	D
3 1/4 I-8	82.5	15.8	202.4
5.00 S-12	127.0	31.3	308.8

### Flat Base rims - Divided Type

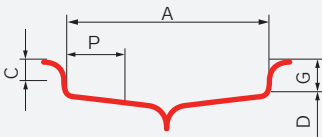

RIM	A	G	D
4.33 R-8	110.0	27.8	205.1

### Flat Base rims

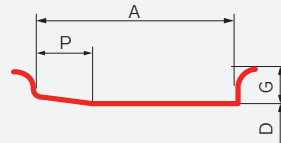

RIM	A	G	D
3.75 P-13	95.2	25.4	330.2
4.33 R-8	110.0	28.6	202.4

## W and DW rims

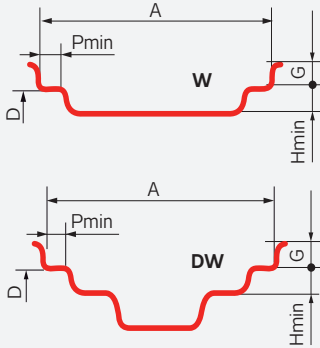

RIM	A	G	Pmin.	Hmin.
W 12	305.0	25.4	27.0	20.6
W 13	330.2	25.4	27.0	20.6
W 14 L	355.6	25.4	27.0	20.6
W 15 L	381.0	25.4	33.0	20.6
W 16 L	406.4	25.4	33.0	20.6
DW 13	330.2	25.4	27.0	20.6
DW 20 A	508.0	28.6	50.8	27.0
DW 14 L	355.6	25.4	36.5	27.0
DW 15 L	381.0	25.4	36.5	27.0
DW 16 L	406.4	25.4	50.5	27.0
DW 18	457.2	25.4	50.8	27.0
DW 20	508.0	28.6	41.3	27.0

Nominal	24"	26"	28"	30"
D	614.4	665.2	716.0	766.8



## Terms and shortcuts used in this catalogue

Acronyms	Meaning	Definition
PR	Ply Rating	Identifies different versions (load capacity/inflation pressure) of tyres having the same size designation.
TYPE	Tubeless or Tube Type	Tubeless (TL) – Tyres specifically designed for fitment without an inner tube on appropriate rims. Tubeless tyres may be used with a tube.
LI	Load Index	Is a numerical code associated with the maximum load a tyre can carry at the speed indicated by its Speed Symbol under service conditions specified by the tyre manufacturer.
SS	Speed Symbol	Indicated the maximum speed at which the tyre can carry a load corresponding to its Load Index under service conditions specified the tyre manufacturer.
	Free Rolling Wheels	Free rolling wheels, that not transmit motion, e.g. trailer
	Drive Wheels	Drive wheels, that transmit motion, e.g. drive wheel axle on tractors
RIM	Recommended Rim	The rim which gives the best fitment of the tyre for all conditions and types of service.
RIM (PERMITTED)	Permitted Rim	Any rim which can be permitted in addition to the recommended rim.
	New Tyre Dimensions	The dimensions of an unloaded new tyre mounted on its Measuring Rim at the recommended inflation pressure and allowed to stand for a minimum of 24 hours at normal room temperature before readjustment of the pressure back to its original level.
	Section Width (design)	The linear distance between the outsides of the sidewalls of an inflated new tyre excluding elevations due to labelling (marking), decorations, or protective bands or ribs.
	Overall Diameter (design)	The diameter of an inflated tyre at the outermost surface of the tread.
	Static Radius (theoretical nominal)	The radius of the new tyre loaded at the maximum load capacity and with the corresponding tyre pressure.
	Rolling Circumference (theoretical nominal)	The circumference of the tyre loaded at the maximum load capacity and with the corresponding tyre pressure.

Acronyms	Meaning	Definition
<b>LOAD CAPACITY</b>	Tyre Load Carrying Capacity	The maximum load (kg) a tyre is permitted to carry under specified operating conditions. In the case of twin-fitted driven wheels, a factor of 1.76 is applied to the load capacity of a single fitment tyre.
	Inflation Pressure	The “cold” pressure (kPa) of the fluid with which the tyre is inflated.
<b>HLV</b>	High Load Variation	Is where the tyre load varies by a factor of “2” or more between loaded and unloaded conditions. The inflation pressure for HLV application must be increased, consult tyre manufacturer. In the case of HLV, the maximum distance should not exceed 1 km and maximum speed 10 km/h. For a longer distance or higher speed, consult tyre manufacturer.
		Example of purpose: without HLV - normal use with constant load in transport service, on tractor in field service, e.g. trailer, tractor; with HLV – use with various load conditions, factor > 2 between loaded and unloaded, e.g. loaders
<b>LLV</b>	Low Load Variation	Standard application with low load difference between loaded and unloaded conditions.
<b>ETRTO</b>	The European Tyre and Rim Technical Organisation	Data in this Technical Databook are relevant with ETRTO standards, the further data you can find there.
	Nominal Section Width	The section width of an inflated tyre mounted on its theoretical rim and indicated in the tyre size designation.
<b>IND</b>		Agricultural tyres for traction wheels for construction applications with load capacities and inflation pressures which differ from those for tyres which the same size designation for use on agricultural tractors.
<b>REINFORCED</b>		Tyres with better protection against tyre damage (puncture). The load capacity and tyre dimensions stay like standard execution.

**Trelleborg Wheel Systems Czech Republic a.s.**  
Švehlova 1900/3, 106 00 Prague 10, Czech Republic



Trelleborg Wheel Systems Czech Republic a.s. is fully compliant with the limits on Polycyclic AromaticHydrocarbons (PAHs) determined by the European Directive EC/2005/69 and REACH Regulation EC/1907/2006, since December 1st 2009.



Your Distributor/Dealer:

**Mitas**

[mitas-tyres.com](http://mitas-tyres.com)