

Agricultural Tyres

Technical Catalogue

Edition 2019/2020





Mitas Technical Catalogue for Agricultural Tyres – Edition 2019 / 2020

The extensive technical data and other information relating to tyres and accessories on the following pages has been compiled to reflect as accurately and completely as possible the current state of development. Due to changes in our product range the tyre sizes given in this guide are not always identical to our available range.

Mitas brand, part of Trelleborg group, is one of Europe's leading tyres brands for agricultural machines, construction vehicles, material handling equipment, motorcycles, bicycles and other specialty segments. Mitas tyres are being produced in the Czech Republic, the United States, Serbia, Slovenia and promoted through a global sales and distribution network.

For further information please contact us:

Trelleborg Wheel Systems Czech Republic a.s.

Švehlova 1900/3, 106 00 Prague 10, Czech Republic

Contents

Tread patterns, markings and definitions

List of tread patterns	4
List of tyre sizes	6
Tyre size marking	10
Speed symbols and conversion tables	11
Tyre sidewall marking and structures	12
Load index	13
Main applications chart	14

Tractor Radial Tyres

HC 1000, HC 2000 – VF tyre (Very High Flexion)	16
SFT – Super Flexion Tyre	24
SST – Silent Speed Tyre	36
AC 65 – 65 series	40
HC 70 – 70 series	48
AC 70 T – 70 series	54
AC 70 G – 70 series	62
AC 85 – standard	66
AC 85 / AC 90 – Row Crop	76

Harvester Radial Tyres

HC 3000 - VF tyre, CFO series – drive wheel	86
CHO – drive wheel	90
SFT & AC 70 H/G/N – drive wheel	96
SFT, AC 70 G, AC 65 IMP – steering wheel	106
Conversion table – tractor and harvester radial tyres	112

Trailer Radial Tyres

Agriterra 02, 03 & 04	116
AR – Agricultural radial	122

Municipal, Agro-industrial and Multipurpose Tyres

HCM – High Capacity Municipal radial	128
Ti-20 & Ti-22 – Agro-industrial radial	134
AC 70 G & MPT-22 – Multipurpose radial (MPT)	138
Agro-industrial diagonal	146

Tractor Diagonal Tyres

AF – Tractor Agro Forestry	156
TD – Tractor Drive (diagonal)	160

Implement Diagonal Tyres

IM – Implement Non Traction	172
TR – Implement Traction	182

Other Tyres

TS & B – Tractor Small	190
TF – Tractor Front	198
B & V – Bantam	208

Use and Maintenance

U.S. Tread pattern marking	210
Use and Maintenance	211
Fitting and removal instructions	212
Liquid ballasting of tractor tyres	213
Explanations referring to tractor tyres	218
Explanations referring to IMP/MPT tyres	220
Rim specification	222
Terms and abbreviations used in this catalogue	226

Tread patterns



Tractor Radial Tyres

Page 16

Trailer Radial Tyres

Page 116

Harvester Radial Tyres

Page 86

Agro-industrial Tyres

Page 128



Tractor Diagonal Tyres

Diagonal Tyres

Page 156

Page 172

List of tyre sizes

Size (inch)	Tyre size (Alternative tyre size)	Tread pattern	Page
Tractor & Harvester Radial			
16"	200/70 R 16	AC 70 T	56
	240/70 R 16	AC 70 T	56
	260/70 R 16	AC 70 T	56
	280/70 R 16	AC 70 T	56
	320/65 R 16	AC 65	42
18"	280/70 R 18	AC 70 T	56
	260/70 R 20	AC 70 T	56
20"	280/70 R 20	AC 70 T	56
	280/85 R 20 (11.2 R 20)	AC 85	68
	300/70 R 20	AC 70 T	56
	320/70 R 20	AC 70 T	56
	360/70 R 20	AC 70 T	56
	380/70 R 20	AC 70 T	58
	420/65 R 20	AC 65 N	42
	420/65 R 20	AC 65	42
	280/85 R 24 (11.2 R 24)	AC 85	68
	320/70 R 24	HC 70	50
	320/70 R 24	AC 70 T	58
	320/85 R 24 (12.4 R 24)	AC 85	68
340/85 R 24 (13.6 R 24)	AC 85	68	
360/70 R 24	HC 70	50	
360/70 R 24	AC 70 T	58	
380/70 R 24	HC 70	50	
380/70 R 24	AC 70 T	58	
380/70 R 24	AC 70 G	64	
380/85 R 24 (14.9 R 24)	AC 85	68	
420/70 R 24	HC 70	50	
420/70 R 24	AC 70 T	58	
420/70 R 24	AC 70 G	64	
420/85 R 24 (16.9 R 24)	AC 85	68	
440/65 R 24	AC 65	42	
460/70 R 24 IMP	AC 70 G	108	
480/65 R 24	AC 65	42	
480/70 R 24	HC 70	50	
480/70 R 24	AC 70 G	64	
500/70 R 24 IMP	AC 70 G	108	
500/85 R 24 IMP	SFT	108	
540/65 R 24	AC 65	42	
25"	1000/50 R 25	SFT	26, 98
26"	620/55 R 26 IMP	SFT	108
	620/75 R 26	SFT	26, 98
	750/65 R 26	SFT	26
28"	280/85 R 28 (11.2 R 28)	AC 85	68
	320/85 R 28 (12.4 R 28)	AC 85	68
	340/85 R 28 (13.6 R 28)	AC 85	68
	380/70 R 28	HC 70	50
	380/70 R 28	AC 70 T	58
	380/85 R 28 (14.9 R 28)	AC 85	68
	420/70 R 28	HC 70	50
	420/70 R 28	AC 70 T	58
	420/70 R 28	AC 70 G	64
	VF 420/85 R 28 (16.9 R 28)	HC 2000	18
	420/85 R 28 (16.9 R 28)	AC 85	70
	440/65 R 28	AC 65	42

Size (inch)	Tyre size (Alternative tyre size)	Tread pattern	Page
	480/65 R 28	AC 65	44
	480/70 R 28	HC 70	50
	480/70 R 28	AC 70 T	58
	500/80 R 28 IMP	SFT	108
	540/65 R 28	SFT	26
	540/65 R 28	AC 65	44
	600/65 R 28	SFT	26
	600/65 R 28	AC 65	44
	600/65 R 28 IMP	AC 65	108
	600/70 R 28	SFT	26
30"	380/85 R 30 (14.9 R 30)	AC 85	70
	420/70 R 30	HC 70	50
	420/70 R 30	AC 70 T	58
	420/85 R 30 (16.9 R 30)	AC 85	70
	420/90 R 30	AC 85	70
	460/85 R 30 (18.4 R 30)	AC 85	70
	480/70 R 30	HC 70	52
	480/70 R 30	AC 70 T	58
	480/70 R 30	AC 70 G	64
	500/85 R 30 IMP	SFT	108
	VF 540/65 R 30	HC 2000	18
	540/65 R 30	SFT	26
540/65 R 30	AC 65	44	
540/65 R 30 IMP	AC 65	108	
600/65 R 30	AC 65	44	
VF 600/70 R 30	HC 2000	18	
600/70 R 30	SFT	28	
620/70 R 30 IMP	SFT	108	
620/70 R 30 IMP	SFT N	108	
620/75 R 30	SFT	28	
620/75 R 30 IMP	SFT	108	
710/55 R 30	SFT	28	
710/60 R 30	SFT	28	
710/60 R 30 IMP	SFT	110	
710/65 R 30 IMP	SFT	110	
750/55 R 30	SFT	28	
32"	270/80 R 32	AC 90	78
	270/95 R 32	AC 85	78
	320/85 R 32 (12.4 R 32)	AC 85	78
	320/90 R 32	AC 85	78
	650/75 R 32	AC 70 H	98
	IF 650/75 R 32	AC 75 G	98
	650/75 R 32	AC 75 G	98
	650/75 R 32	AC 70 G	100
	680/85 R 32 CHO	AC 70 G	92
	680/85 R 32	AC 70 G	100
	800/65 R 32	AC 70 H	100
	800/65 R 32	AC 70 N	100
800/70 R 32 CHO	SFT	92	
800/70 R 32	SFT	28, 102	
900/60 R 32 CHO	SFT	92	
900/60 R 32	SFT	28, 102	
900/70 R 32 CHO	SFT	92	
900/70 R 32	SFT	30, 102	

Size (inch)	Tyre size (Alternative tyre size)	Tread pattern	Page
	VF 1000/65 R 32 CHO	HC 3000 R	88
	1050/50 R 32 CHO	SFT	92
	1050/50 R 32	SFT	30, 102
	1250/50 R 32 CHO	SFT	92
	1250/50 R 32	SFT	30, 102
34"	320/85 R 34	AC 85	78
	VF 380/85 R 34 (14.9 R 34)	HC 2000	18
	380/85 R 34 (14.9 R 34)	AC 85	70
	VF 420/85 R 34 (16.9 R 34)	HC 2000	18
	420/85 R 34 (16.9 R 34)	AC 85	70
	460/85 R 34 (18.4 R 34)	AC 85	70
	480/70 R 34	HC 70	52
	480/70 R 34	AC 70 T	60
	480/70 R 34	AC 70 G	64
	500/85 R 34 IMP	SFT	110
	500/85 R 34 IMP	SFT N	110
	520/70 R 34	HC 70	52
	520/70 R 34	AC 70 T	60
	520/70 R 34	AC 70 G	64
	VF 540/65 R 34	HC 2000	18
	540/65 R 34	AC 65	44
	VF 580/80 R 34 CFO	HC 3000	88
	600/65 R 34	AC 65	44
	650/60 R 34	SFT	30
	650/65 R 34	SFT	30
	710/60 R 34	SFT	30
36"	270/80 R 36	AC 90	78
	13.6 R 36	AC 90	80
38"	320/85 R 38 (12.4 R 38)	AC 85	80
	340/85 R 38 (13.6 R 38)	AC 85	70, 80
	380/80 R 38 (14.9 R 38)	AC 85	72
	VF 380/95 R 38	HC 2000	18
	380/95 R 38	AC 85	72
	15.5 R 38	AC 51	72
	420/85 R 38 (16.9 R 38)	AC 85	72
	460/85 R 38 (18.4 R 38)	AC 85	72
	480/70 R 38	HC 70	18
	480/70 R 38	AC 70 T	52
	VF 480/70 R 38	HC 2000	60
	520/70 R 38	HC 70	52
	520/70 R 38	AC 70 T	60
	520/70 R 38	AC 70 G	64
	520/85 R 38 (20.8 R 38)	AC 85	72
	540/65 R 38	AC 65	44
	580/70 R 38	HC 70	52
	580/70 R 38	AC 70 T	60
	600/65 R 38	SST	38
	600/65 R 38	AC 65	46
	650/65 R 38	SFT	30
	650/65 R 38	SST	38
	650/65 R 38	AC 65	46, 80
	650/75 R 38	SFT	32
	650/85 R 38	SFT	32
	680/80 R 38 CHO	SFT	92

Size (inch)	Tyre size (Alternative tyre size)	Tread pattern	Page
	710/70 R 38	SFT	32
	710/70 R 38	SST	38
	710/70 R 38	AC 65	46
	800/70 R 38 CHO	SFT	94
	800/70 R 38	SFT	32
	900/60 R 38 CHO	SFT	94
	900/60 R 38	SFT	32, 104
42"	300/85 R 42 (11.2 R 42)	AC 90	80
	300/95 R 42 (12.4 R 42)	AC 90	80
	IF 320/90 R 42	AC 85	82
	320/90 R 42	AC 85	80
	480/80 R 42	AC 85	72
	VF 520/85 R 42 (20.8 R 42)	HC 2000	18
	VF 520/85 R 42 CFO [20.8 R 42]	HC 3000	88
	520/85 R 42 (20.8 R 42)	AC 85	72
	VF 580/85 R 42 CFO	HC 3000	88
	580/85 R 42	SFT	32, 104
	VF 650/65 R 42	HC 2000	20
	650/65 R 42	SST	38
	650/65 R 42	AC 65	46
	650/75 R 42	SFT	34
	680/80 R 42 CHO	SFT	94
	680/80 R 42	SFT	34, 104
	VF 710/70 R 42	HC 2000	20
	VF 710/70 R 42 CFO	HC 3000	88
	710/70 R 42	SFT	34
	710/70 R 42	SST	38
	710/75 R 42	SFT	34
	710/75 R 42	SST	38
	800/70 R 42 CHO	SFT	94
	900/60 R 42	SFT	34
	900/60 R 42 CHO	SFT	94
46"	320/95 R 46	AC 85	82
	VF 380/90 R 46	HC 1000	22
	380/90 R 46	AC 85	82
	VF 480/80 R 46	HC 2000	20
	480/80 R 46	AC 85	72
	520/85 R 46 (20.8 R 46)	AC 85	72
	710/65 R 46	SFT	34
	IF 710/65 R 46	SFT	34
48"	270/95 R 48	AC 90	82
	340/90 R 48 (13.6 R 48)	AC 85	82
50"	320/90 R 50	AC 85	82
	380/90 R 50	AC 85	74, 82
	VF 380/105 R 50	HC 1000	22
	VF 480/80 R 50	HC 1000	22
	480/80 R 50	AC 85	74
	VF 480/95 R 50	HC 2000	20
	480/95 R 50	AC 85	74
54"	320/90 R 54	AC 85	84
	VF 320/105 R 54	HC 1000	22
	380/90 R 54	AC 85	84
	VF 380/105 R 54	HC 2000	20
	380/105 R 54	AC 85	84

List of tyre sizes (continued)

Size (inch)	Tyre size (Alternative tyre size)	Tread pattern	Page
Trailer Radial			
17"	440/50 R 17 IMP	AR-04	126
	500/50 R 17 IMP	AR-03	126
18"	335/60 R 18 MPT	AR-05	126
22.5"	385/65 R 22.5 (15 R 22.5)	AR-01	124
	445/65 R 22.5 (18 R 22.5)	AR-01	124
	460/65 R 22.5 IMP	AR-01	124
	500/60 R 22.5 IMP	Agriterra 02	118
	560/45 R 22.5 IMP	Agriterra 02	118
	560/60 R 22.5 IMP	Agriterra 02	118
	560/60 R 22.5 IMP	AR-02	126
	600/50 R 22.5 IMP	Agriterra 02	118
	710/45 R 22.5 IMP	Agriterra 02	118
26.5"	600/55 R 26.5 IMP	Agriterra 02	118
	650/55 R 26.5 IMP	Agriterra 02	118
	650/65 R 26.5 IMP	Agriterra 02	120
	710/50 R 26.5 IMP	Agriterra 02	120
30.5"	800/45 R 26.5 IMP	Agriterra 03	120
	600/60 R 30.5 IMP	Agriterra 04	120
	680/60 R 30.5 IMP	Agriterra 03	120
32"	750/60 R 30.5 IMP	Agriterra 02	120
	850/50 R 30.5 IMP	Agriterra 02	120
	800/65 R 32 IMP	Agriterra 04	120
Municipal, Agro - industrial Radial			
18"	340/80 R 18 IND	HCM	130
	340/80 R 18 IND	TI-20	136
24"	360/80 R 24 IND	HCM	130
	400/80 R 24 IND	HCM	130
	440/80 R 24 IND	HCM	130
	460/70 R 24 IND (17.5L R 24)	TI-22	136
26"	480/80 R 26 IND	TI-20	136
28"	400/80 R 28 IND	HCM	130
	440/70 R 28 IND	AC 70 G	136
	440/80 R 28 IND	HCM	130
	440/80 R 28 IND	TI-20	136
30"	540/65 R 30 IND	HCM	130
34"	440/80 R 34 IND	HCM	130
	480/80 R 34 IND	HCM	132
38"	480/80 R 38 IND	HCM	132
	540/80 R 38 IND	HCM	132
42"	650/65 R 42 IND	HCM	132
Multipurpose Radial			
16"	265/70 R 16 MPT	AC 70 G	140
	285/80 R 16 MPT	AC 70 G	140
17"	425/55 R 17 MPT	AC 70 G	140
18"	325/70 R 18 MPT	AC 70 G	140
	365/70 R 18 MPT	AC 70 G	140
20"	275/80 R 20 MPT	AC 70 G	140
	335/80 R 20 MPT	AC 70 G	140
	375/70 R 20 MPT	AC 70 G	142
	405/70 R 20 MPT	AC 70 G	142
	425/75 R 20 MPT	AC 70 G	142
22.5"	445/65 R 22.5 MPT	AC 70 +	142
	405/70 R 24 MPT	AC 70 G	142
24"	445/70 R 24 MPT	AC 70 G	142
	445/70 R 24 MPT (17.5L R 24)	MPT-22	142
	495/70 R 24 MPT	AC 70 G	144
	495/70 R 30 MPT	AC 70 G	144
Agro - industrial Diagonal			
18"	280/80 -18 (10.5 -18)	MPT-01	148
	275/80 -18 MPT (10.5 -18)	TD-10	148
	320/80 -18	TD-10	154
	340/80 -18 (12.5 -18)	MPT-01	148

Size (inch)	Tyre size (Alternative tyre size)	Tread pattern	Page
20"	275/80 -20 MPT	TD-10	148
	335/80 -20 MPT	TD-10	148
	340/80 -20 (12.5 -20)	MPT-01	148
	360/80 -20	TD-10	154
	365/80 -20 MPT	TD-10	148
	400/70 -20	TD-10	154
	400/70 -20	TR-01	150
	405/70 -20 (16/70 -20)	MPT-01	150
24"	155/80 -24	TR-01	150
	155/80 -24	TD-10	154
	400/80 -24 IND (15.5/80 -24)	TI-05	152
	405/70 -24 (16/70 -24)	MPT-01	150
	16.5/85 -24	TD-10	154
	17.5L -24	TR-01	150
	460/70 -24 IND	TI-05	152
	460/70 -24 IND (17.5L -24)	TR-01	152
	19.5L -24 IND	TI-05	152
	500/70 -24 IND (19.5L -24)	TI-05	152
30"	16.9 -30 IND	TD-03	152
Tractor Agro Forestry			
24"	380/85 -24 (14.9 -24)	AF-01	158
28"	380/85 -28 (14.9 -28)	AF-01	158
30"	16.9 -30	TI-01	158
34"	420/85 -34 (16.9 -34)	AF-01	158
	460/85 -34 (18.4 -34)	AF-01	158
Tractor Diagonal			
20"	8.3 -20	TD-13	162
24"	8.3 -24	TD-02	162
	9.5 -24	TD-02	162
	11.2 -24	TD-02	162
	11.2 -24	TD-10	162
	11.2 -24	TD-19	162
	12.4 -24	TD-02	162
	12.4 -24	TD-19	162
	13.6 -24	TD-19	162
	14.9 -24	TD-02	162
	14.9 -24	TD-19	164
	16.9 -24	TD-02	164
	16.9 -24	TD-13	164
26"	18.4 -26	TD-19	164
	23.1 -26	TD-01	164
28"	11.2 -28	TD-02	164
	12.4 -28	TD-19	164
	12.4 -28	TD-02	164
	13.6 -28	TD-19	164
	14.9 -28	TD-19	166
	16.9 -28	TD-02	166
	16.9 -28	TD-13	166
30"	16.9 -30	TD-13	166
	16.9 -30	TD-17	166
	18.4 -30	TD-13	166
32"	9.5 -32	TD-13	166
	12.4 -32	TD-13	166
34"	16.9 -34	TD-02	166
	16.9 -34	TD-17	168
	18.4 -34	TD-19	168
	18.4 -34	TD-02	168
36"	12.4 -36	TD-13	168
	13.6 -36	TD-13	168
38"	11.2 -38	TD-13	168
	12.4 -38	TD-17	168
	13.6 -38	TD-02	168
	13.6 -38	TD-13	168

Size (inch)	Tyre size (Alternative tyre size)	Tread pattern	Page
	14.9-38	TD-05	170
	15.5-38	TD-05	170
	16.9-38	TD-19	170
	16.9-38	TD-13	170
	18.4-38	TD-19	170
Implement Diagonal			
6"	13×5.00-6	G 1	174
	13×5.00-6	B 19	174
	15×6.00-6	B 19	174
8"	16×6.50-8	B 19	174
	18×8.50-8	G 1	174
	18.5×8.50-8	B 63	174
10"	4.00-10	IM-06	174
12"	7.00-12	IM-11	174
	10.0/80-12	IM-04	174
	10.0/80-12	IM-08	174
14.5"	200/60-14.5	IM-10	176
15"	240/70-15	B 3	176
	28×9.00-15	AC30	176
	31×15.50-15	TR-06	184
	31×15.50-15	TR-07	184
15.3"	10.0/75-15.3	IM-04	176
	10.0/75-15.3	TR-03	184
	10.0/75-15.3	TR-04	184
	11.5/80-15.3	IM-04	176
	11.5/80-15.3	TR-03	184
	12.5/80-15.3	IM-04	176
15.5"	400/60-15.5	IM-07	178
	400/60-15.5	TR-08	184
16"	10.50-16	IM-01	178
17"	15.0/55-17	IM-04	178
	15.0/55-17	TR-01	186
	19.0/45-17	IM-04	178
	480/45-17	TR-01	186
	500/50-17	IM-07	178
17.5"	14-17.5	TR-10	186
18"	12.0/75-18	TR-03	186
	12.0/75-18	TR-11	186
	12.5/80-18	IM-03	178
	12.5/80-18	IM-04	180
	13.0/65-18	IM-04	180
	360/95-18	IM-02	180
	14.5/80-18	IM-03	180
	14.5/80-18	TR-05	186
20"	500/45-20	TR-12	186
22.5"	500/60-22.5	TR-08	188
	500/60-22.5	IM-09	180
	500/60-22.5	TR-12	188
	550/60-22.5	IM-09	180
	550/60-22.5	TR-08	188
	600/40-22.5	TR-12	188
	600/50-22.5	TR-08	188
Tractor Small			
6"	3.50-6	B 16	192
	13×5.00-6	B 12	192
8"	3.50-8	B 16	192
	4.00-8	TS-01	192
	4.00-8	B 12	192
	16×6.50-8	B 64	192
10"	4.00-10	B 12	192
	4.0-10	TS-03	192
	4.0-10	B 17	192
	5.00-10	B 16	192

Size (inch)	Tyre size (Alternative tyre size)	Tread pattern	Page
	5.0-10	TS-03	192
	5.0-10	B 17	192
12"	4.00-12	B 12	192
	5.00-12	TS-02	192
	5.00-12	B 12	192
	6.5/90-12 (170/90-12)	TS-06	194
	6.5/80-12	B 18	194
	11.0/65-12	TD-10	194
14"	6.5/75-14	TS-02	194
15"	5.00-15	TS-06	194
	6.5/90-15 (170/90-15)	TS-06	194
	6.5/90-15	TS-07	194
15.3"	10.0/75-15.3	TS-05	194
	11.5/80-15.3	TS-05	196
16"	6.00-16	TS-04	196
	6.00-16	TD-13	196
	6.50-16	TD-10	196
	7.50-16	TS-04	196
	7.50-16	TD-13	196
20"	7.50-20	TS-04	196
	7.50-20	TD-13	196
	8.3-20	TD-13	196
Tractor Front			
16"	4.00-16	TF-02	200
	4.50-16	TF-02	200
	5.00-16	TF-02	200
	6.00-16	TF-01	200
	6.00-16	TF-02	200
	6.00-16	TF-03	200
	6.00-16	TF-06	200
	6.50-16	TF-02	200
	6.50-16	TF-03	202
	6.50-16	TF-05	202
	7.50-16	TF-01	202
	7.50-16	TF-01	202
	7.50-16	TF-03	202
	7.50-16	TF-05	202
	9.00-16	TF-03	202
	10.00-16	TF-03	204
	11L-16	IM-05	204
18"	6.00-18	TF-03	204
	6.00-18	TF-04	204
20"	6.50-20	TF-03	204
	6.50-20	TF-04	204
	6.50-20	TF-05	204
	7.50-20	TF-01	204
	7.50-20	TF-03	204
	7.50-20	TF-05	206
Bantam			
6"	3.50-6	B 15	209
	3.50-6	B 15 Ribbed	209
	4.00-6	V-5501	209
	4.00-6	B 11	209
8"	16×4	B2	209
	16×4	B5	209
	3.50-8	B6	209
	3.50-8	V-5501	209
	3.50-8	B 11	209
	3.50-8	B 15	209
	4.00-8	V-5501B	209
	4.00-8	V-5501A	209
	4.00-8	B 11	209

Tyre size marking

340/85 R 24	
340	Nominal section width (in mm)
85	Aspect ratio H/SW (in %)
R	Radial construction
24	Nominal rim diameter (in inches)

15.0/55 – 17	
15.0	Nominal section width (in inches)
55	Aspect ratio H/SW (in %)
–	Cross-ply construction
17	Nominal rim diameter (in inches)

31 × 15.50 – 15	
31	Overall diameter (in inches)
15.50	Nominal section width (in inches)
–	Cross-ply construction
15	Nominal rim diameter (in inches)

17.5 L – 24	
17.5	Nominal section width (in inches)
L	Reduced aspect ratio
–	Cross-ply construction
24	Nominal rim diameter (in inches)

7.50 – 20	
7.50	Nominal section width (in inches)
–	Cross-ply construction
20	Nominal rim diameter (in inches)

16 × 4	
16	Overall diameter (in inches)
4	Nominal section width (in inches)

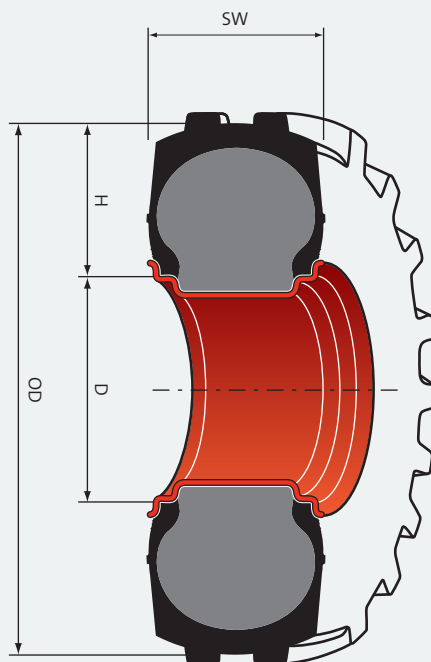

SW Section width
 OD Overall diameter
 H Section height
 D Rim diameter

Speed symbols and conversion tables

Speed category

Speed symbol	A1	A2	A3	A4	A5	A6	A7	A8	B	D	F	G	J	K
Speed (km/h)	5	10	15	20	25	30	35	40	50	65	80	90	100	110

Pressure units conversion table

bar	1.0	1.5	2.0	2.5	3.0	3.5	4.0	4.5	5.0	5.5
kPa	100	150	200	250	300	350	400	450	500	550
p. s. i.	15	22	29	36	44	51	58	65	73	80

bar	6.0	6.5	7.0	7.5	8.0	8.5	9.0	9.5	10.0	10.5
kPa	600	650	700	750	800	850	900	950	1 000	1 050
p. s. i.	87	94	102	109	116	123	131	138	145	152

Units conversion table

Length	Mass	Pressure
1 millimeter (mm) = 0.03937"	1 pound (lb) = 0.4536 kg	1 p. s. i. (lb/in ²) = 6.895 kPa
1 inch (") = 25.4 mm = 0.0254 m	1 kilogram (kg) = 2.205 lb	1 kg/cm ² = 98.066 kPa
1 meter (m) = 3.281 ft		1 bar = 100 kPa
1 foot (ft) = 0.3048 m	Volume	
1 kilometer (km) = 0.6214 mile	1 litre (l) = 0.21 gall	
1 mile = 1 609 m = 1.609 km	1 imperial gallon (imp.gal) = 4.55 l	

Tyre sidewall marking



Sign	Meaning
MITAS	Tyre brand
480/70 R 34	Tyre size marking
HC 70	Tread pattern code
146	Load index (LI 146 = 3 000 kg)
A8	Speed symbol (A8 = 40 km/h)
143	Load index (LI 143 = 2 725 kg)
D	Speed symbol (D = 65 km/h)
TUBELESS	Tubeless tyre
	Direction of rotation
R-1W	US tread profile marking

Tyre structure

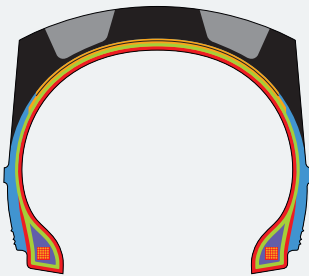

- Tread Pattern
- Breaker Cord
- Inner Liner
- Carcass Cord
- Sidewall
- Apex
- Bead Wire



DIAGONAL (CROSS-PLY, BIAS) TYRE

A pneumatic tyre in which the ply cords extend to the beads and are laid substantially at alternate angles less than 90° to the centre-line of the tread.



RADIAL PLY TYRE

A pneumatic tyre in which the ply cords extend to the beads and are laid substantially at 90° to the centre-line of the tread, the carcass being stabilised by an essentially inextensible circumferential belt.

Load index

LI	kg	LI	kg	LI	kg	LI	kg	LI	kg
30	106	65	290	100	800	135	2 180	170	6 000
31	109	66	300	101	825	136	2 240	171	6 150
32	112	67	307	102	850	137	2 300	172	6 300
33	115	68	315	103	875	138	2 360	173	6 500
34	118	69	325	104	900	139	2 430	174	6 700
35	121	70	335	105	925	140	2 500	175	6 900
36	125	71	345	106	950	141	2 575	176	7 100
37	128	72	355	107	975	142	2 650	177	7 300
38	132	73	365	108	1 000	143	2 725	178	7 500
39	136	74	375	109	1 030	144	2 800	179	7 750
40	140	75	387	110	1 060	145	2 900	180	8 000
41	145	76	400	111	1 090	146	3 000	181	8 250
42	150	77	412	112	1 120	147	3 075	182	8 500
43	155	78	425	113	1 150	148	3 150	183	8 750
44	160	79	437	114	1 180	149	3 250	184	9 000
45	165	80	450	115	1 215	150	3 350	185	9 250
46	170	81	462	116	1 250	151	3 450	186	9 500
47	175	82	475	117	1 285	152	3 550	187	9 750
48	180	83	487	118	1 320	153	3 650	188	10 000
49	185	84	500	119	1 360	154	3 750	189	10 300
50	190	85	515	120	1 400	155	3 875	190	10 600
51	195	86	530	121	1 450	156	4 000	191	10 900
52	200	87	545	122	1 500	157	4 125	192	11 200
53	206	88	560	123	1 550	158	4 250	193	11 500
54	212	89	580	124	1 600	159	4 375	194	11 800
55	218	90	600	125	1 650	160	4 500	195	12 150
56	224	91	615	126	1 700	161	4 625	196	12 500
57	230	92	630	127	1 750	162	4 750	197	12 850
58	236	93	650	128	1 800	163	4 875	198	13 200
59	243	94	670	129	1 850	164	5 000	199	13 600
60	250	95	690	130	1 900	165	5 150	200	14 000
61	257	96	710	131	1 950	166	5 300		
62	265	97	730	132	2 000	167	5 450		
63	272	98	750	133	2 060	168	5 600		
64	280	99	775	134	2 120	169	5 800		

Main applications – Radial Tyres

We offer a wide range of tyres for almost every piece of equipment and application – from high-horsepower tractors to massive harvesters, from field preparation to harvest.

Our extensive line of radial agricultural tyres offers solutions to all your needs, from our **High Capacity Tyres (HC)** and **Super Flexion Tyres (SFT)** series or our wide footprint **HC 70** and **AC 65** series tyres to our **AC 85** and **AC 90** series for row-crop applications.

The development of the **Silent Speed Tyres (SST)**, connects the outstanding field characteristics of a 65 series wide tyre with high comfort. Because with the SST the noise level in the operator's cab is reduced to a minimum. The **High Capacity Tyres (HC)** and **Super Flexion Tyres (SFT)** were developed primarily for powerful machines with over 180 hp. The extremely large volume of air ensures gentle ground handling when working with heavy loads. The new harvester tyres **HC 3000** and **SFT CHO** have been designed as an extremely powerful



	HC 2000	HC 1000	Super Flexion Tyres (SFT)	Silent Speed Tyres (SST)	AC 65	
Product on page	16	16	24	36	40	
Type of tyre	VF (Very High Flexion)	VF (Very High Flexion)	Super Flexion	Wide 65 series	Wide 65 series	
Tractor (hp)	> 180	–	> 180	< 220	< 220	
Max speed	65 km/h	65 km/h	65 km/h	65 km/h	65 km/h	
Road performance, Transports	++++	+++	+++++	+++++	++++	
Field work	+++++		+++++	++++	++++	
→ Cultivating, tillage (high torque)	+++++		+++++	++++	++++	
→ Seedbed preparation (high load)	+++++		+++++	++++	++++	
Grassland application	+++++		+++++	++++	++++	
Row crop applications		+++++		+	+	
Harvester						
Vineyard & fruit growing		++++		+	++	

tyres for big combine harvesters. **HC 3000** and **SFT CHO** are capable of higher maximum loads; at the same time the tyre permits gentler ground handling in the field and more comfort on the road. For tractors with up to 200 hp, the Mitas range of radial tyres offers wide choice of all-rounders. The 85 series standard radial **AC 85** is ideally suited for wide-ranging applications in the field and on the road. The **HC 70** the new 70 series wide tyre, has higher load capacities than normally available in the 70 series segment; it therefore offers gentler

ground handling and can carry very heavy loads. The **AC 65** is a wide tyre with a 65% aspect ratio and is the ideal choice in this tractor segment, where it's about gentle ground handling and the ability to transport heavy loads, as well as traction and grassland suitability. The **AC 70 G** is the acknowledged grassland tyre in Mitas portfolio. The **AC 70 T** is particularly suited for heavy field work. In the smaller sizes it has proved itself in vine cultivation and fruit growing.



	HC 70	AC 70 T	AC 70 G	AC 85	AC 85 / 90 Row Crop	HC 3000	CHO	SFT Harvester AC 70 H/G/N
	48	54	62	66	76	86	90	96
	Wide 70 series	Wide 70 series	Wide 70 series	Standard 85 series	Row Crop	Harvester (Cyclic Field Operation)	Harvester (Cyclic Harvesting Application)	Harvester
	< 200	< 200	< 200	< 220	–	–	–	–
	65 km/h	50 km/h	90 km/h	50 km/h	50 km/h	50 km/h	50 km/h	50 km/h
	+++	++	++++	+++	++	+++	+++	+++
	+++	+++	+++	+++				
	++++	+++	++++	+++				
	+++	++	+++	+++				
	++++	++	+++	+++		++++	++++	++++
	++	++	++	++++	++++			
						++++	++++	++++
	+++	++++	+++	+++	++++			

+++++ excellent ++++ very good +++ good ++ suitable + somewhat suitable



HC 2000

LOAD CAPACITY	=====
TRACTION	=====
SOIL PROTECTION	=====
HANDLING ON ROAD	=====
COST EFFICIENCY	=====



HC 1000

LOAD CAPACITY	=====
TRACTION	=====
SOIL PROTECTION	=====
HANDLING ON ROAD	=====
COST EFFICIENCY	=====

HC 2000 – VF tyre (Very High Flexion)

For high-horsepower tractors



Lower inflation pressure provides **excellent traction efficiency**.



Better ground protection thanks to reduced soil compaction.



Higher load capacity for higher haulage efficiency.

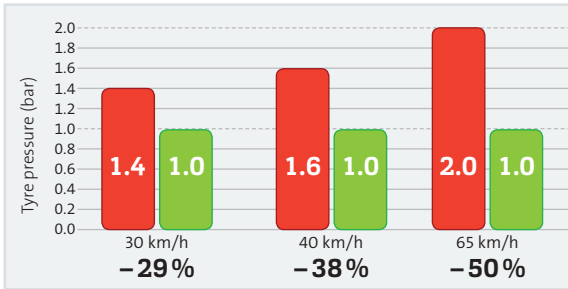

**Constant tyre pressure
at any speed (VF concept)**
For a load capacity 2 930 kg

■ 540/65 R 30 Standard
■ Mitas VF 540/65 R 30 HC 2000

HC 1000 – Narrow VF tyre

For self-propelled sprayers



More lugs provide **better durability, longer service life and lower operation cost**.



Higher maximum speed (65 km/h) for less time on the road.



Reduced soil compaction for higher loads thanks to lower inflation pressure.

HC 2000

Technical data and load capacities

Tyre size	Service description LI/SS	Rims * (permitted)	Section width (mm)	Overall diameter (mm)	Loaded static radius (mm)	Rolling circumference (mm)	Speed radius index	
VF 420/85 R 28	151 D	DW 15 L DW 14 L	440	1 430	640	4 260	675	
VF 540/65 R 30	155 D	DW 20 B DW 18 L W 16 L	549	1 464	660	4 410	700	
VF 540/65 R 30	161 D (158 E)	DW 20 B DW 18 L W 18 L	574 554 554	1 491	660	4 410	700	
VF 600/70 R 30	165 D	DW 21 B DW 20 B	603 593	1 595	695	4 690	750	
VF 380/85 R 34	149 D	DW 13 L DW 12 L	390	1 535	695	4 570	725	
VF 420/85 R 34	154 D	DW 14 L DW 15 L	420 430	1 580	710	4 700	750	
VF 540/65 R 34	163 D	DW 20 B DW 18 L W 18 L	550 530 530	1 566	705	4 675	750	
VF 380/95 R 38	154 B	DW 13 L DW 12 L	394 384	1 670	735	4 950	800	
VF 480/70 R 38	172 D	DW 16 L DW 15 L DW 18 L	486 476 506	1 641	760	5 090	800	
VF 520/85 R 42	174 B	DW 18 L DW 16 L	552	1 966	895	5 875	925	



Tyre load capacity (kg) at tyre pressure (bar)												Speed (km/h)
0.4	0.6	0.8	1.0	1.2	1.4	1.6	2.0	2.4	2.8	3.2	4.0	
1 385	1 660	2 245 2 420 1 935	2 515 2 565 2 765 2 215	2 830 2 885 3 115 2 490	3 145 3 210 3 460 2 765	3 450 3 520 3 795 3 035						40-65 30 10 40-65 Dual
1 680	2 000	2 680 2 890 2 310	2 900 2 960 3 190 2 550	3 250 3 315 3 575 2 860	3 620 3 690 3 980 3 185	3 875 3 955 4 265 3 410						40-65 30 10 40-65 Dual
1 680	2 000	2 680 2 890 2 310	2 650 2 900 2 960 3 190 2 550	3 000 3 250 3 315 3 575 2 860	3 295 3 620 3 690 3 980 3 185	3 550 4 250 3 875 3 955 4 335 4 720 4 675 3 740	3 875 4 250	4 250 4 625				70 40-65 30 10 40-65 Dual
2 080	2 495	3 370 3 635 2 910	3 780 3 855 4 160 3 325	4 250 4 335 4 675 3 740	4 725 4 820 5 200 4 160	5 150 5 255 5 665 4 530						40-65 30 10 40-65 Dual
1 290	1 550	2 095 2 260 1 810	2 350 2 395 2 585 2 065	2 645 2 700 2 910 2 325	2 935 2 995 3 230 2 585	3 250 3 315 3 575 2 860						40-65 30 10 40-65 Dual
1 505	1 810	2 445 2 635 2 110	2 740 2 795 3 015 2 410	3 080 3 140 3 390 2 710	3 425 3 495 3 770 3 015	3 750 3 825 4 125 3 300						40-65 30 10 40-65 Dual
	2 080	2 780 3 000 2 400	2 800 3 075 3 135 3 385 2 710	3 150 3 450 3 520 3 795 3 040	3 450 3 805 3 880 4 185 3 345	3 750 4 125 4 210 4 540 3 630	4 125 4 500 4 590 4 950 3 960	4 500 4 875	4 975 5 365 4 290			70 40-65 30 10 40-65 Dual
1 500	1 800	2 440 2 630 2 100	2 730 2 785 3 005 2 400	3 070 3 130 3 375 2 700	3 410 3 480 3 750 3 000	3 750 3 825 4 125 3 300						40-50 30 10 40-50 Dual
1 170	1 460	2 195 2 365 1 890	3 000 3 060 3 300 2 640	3 350 3 415 3 685 2 950	3 750 3 825 4 125 3 300	4 125 4 210 4 540 3 630	4 500 4 590 4 950 3 960	4 750 4 845 5 225 4 180	5 150 5 255 5 665 4 530	5 600 5 710 6 160 4 930	6 300 6 425 6 930 5 545	40-50 30 10 40-50 Dual
2 300	2 760	3 735 4 025 3 220	4 180 4 265 4 600 3 680	4 705 4 800 5 175 4 140	5 225 5 330 5 750 4 600	5 750 5 865 6 325 5 060	6 300 6 425 6 930 5 545	6 700 6 835 7 370 5 895				40-50 30 10 40-50 Dual

HC 2000 (continued)

Technical data and load capacities

Tyre size	Service description LI/SS	Rims * (permitted)	Section width (mm)	Overall diameter (mm)	Loaded static radius (mm)	Rolling circumference (mm)	Speed radius index
VF 650/65 R 42	170 D	DW 23 B DW 21 B	650	1 913	860	5 740	925
VF 710/70 R 42	179 D	DW 25 B DW 23 B	730 710	2 050	920	6 125	975
VF 480/80 R 46	164 D	DW 16 L DW 15 L DW 18 L	479 469 499	1 936	870	5 800	925
VF 480/80 R 46	175 D	DW 16 L DW 15 L DW 18 L	496 486 516	1 941	870	5 800	925
VF 480/95 R 50	170 B	DW 16 L DW 15 L DW 18 L	480 470 500	2 160	970	6 400	1 075
VF 380/105 R 54	168 B	W 13 L W 12 L	385 375	2 170	990	6 500	1 075

* Further admissible rims on request

Load values for 0.4 bar and 0.6 bar are for calculating Dual and triple load values only.

For plowing with single driven tyres in the furrow, a minimum inflation pressure of 0.8 bar is required.

For intensive road transport at 65/50/40/30 km/h the pressure must be increased by 0.4 bar. Maximum inflation pressure should never be exceeded.

All load values are valid for ground slopes up to and including 20% (11°). When operating on slopes greater than 20%, please, contact the producer.

Tubeless tyres – may be used with a tube.

HC 2000



	Tyre load capacity (kg) at tyre pressure (bar)											Speed (km/h)	
	0.4	0.6	0.8	1.0	1.2	1.4	1.6	2.0	2.4	2.8	3.2		4.0
			4 130	4 585	5 105	5 590	6 000						40–65 30 10
	2 595	3 085	4 455	5 045	5 615	6 150	6 600						40–65 Dual
			4 305	4 035	4 495	4 920	5 280						
			4 995	5 590	6 290	6 990	7 750						40–65 30 10
	3 075	3 690	5 385	5 700	6 415	7 130	7 905						40–65 Dual
			4 305	4 920	5 535	6 150	6 820						
			3 250	3 650	4 095	4 565	5 000						40–65 30 10
	2 000	2 410	3 505	3 725	4 175	4 655	5 100						40–65 Dual
			2 800	3 210	3 600	4 015	4 400						
			3 250	3 650	4 095	4 565	5 000	5 450	5 800	6 500	6 900		40–65 30 10
	2 000	2 410	3 505	4 015	4 505	5 020	5 500	5 995	6 380	7 150	7 590		40–65 Dual
			2 800	3 210	3 600	4 015	4 400	4 795	5 105	5 720	6 070		
			3 955	4 430	4 985	5 540	6 000						40–50 30 10
	2 435	2 925	4 265	4 520	5 085	5 650	6 120						40–50 Dual
			3 410	3 900	4 385	4 875	5 280						
			3 120	3 500	3 935	4 375	4 810	5 300	5 600				40–50 30 10
	1 925	2 310	3 365	3 570	4 015	4 465	4 905	5 405	5 710				40–50 Dual
			2 695	3 080	3 465	3 850	4 235	4 665	4 930				

HC 1000

Technical data and load capacities

Tyre size	Service description L/SS	Rims * (permitted)	Section width (mm)	Overall diameter (mm)	Loaded static radius (mm)	Rolling circumference (mm)	Speed radius index
VF 380/90 R 46	173 D	DW 13 L DW 12 L	405 395	1 855	835	5 540	875
VF 380/105 R 50	176 D	DW 13 L DW 12 L	385 375	2 050	930	6 200	975
VF 480/80 R 50	181 D (184 A8)	DW 16 L DW 15 L DW 18 L	500 490 510	2 050	910	6 100	975
VF 320/105 R 54	169 D	DW 11 L DW 10 L	323 313	2 044	920	6 150	975

* Further admissible rims on request

For intensive road transport at 65/50/40/30 km/h the pressure must be increased by 0.4 bar. Maximum inflation pressure should never be exceeded. All load values are valid for ground slopes up to and including 20% (11°). When operating on slopes greater than 20%, please, contact the producer. Tubeless tyres – may be used with a tube.

HC 1000



	Tyre load capacity (kg) at tyre pressure (bar)							Speed (km/h)
	1.0	1.6	2.4	3.2	3.6	4.0	4.4	
	2 800 2 465	3 875 3 410	4 625 4 070	5 425 4 775	5 775 5 080	6 125 5 390	6 500 5 720	0–65 0–65 Dual
	3 450 3 036	4 625 4 070	5 450 4 796	6 300 5 544	6 900 6 072	7 100 6 248		0–65 0–65 Dual
	3 870 3 405	5 320 4 680	5 840 5 140	6 220 5 475	7 365 6 470	8 250 7 260		0–65 0–65 Dual
	2 730 2 400	3 750 3 300	4 115 3 620	4 385 3 860	5 185 4 560	5 800 5 105		0–65 0–65 Dual

Tractor Radial Tyres | SFT

kW	22	44	66	88	110	132	162	191	>220
hp	30	60	90	120	150	180	220	260	>300



SFT



Super Flexion Tyre (SFT)

Maximum load capacity and traction for powerful machines



Developed for use on **high-horsepower tractors (> 180 hp) and combines.**



Flexible sidewalls allow low inflation pressures **for high load-carrying capacities**, gentle ground handling and higher yields.



Maximum traction and outstanding productivity thanks to transport speeds of 65 km/h and a large contact patch.

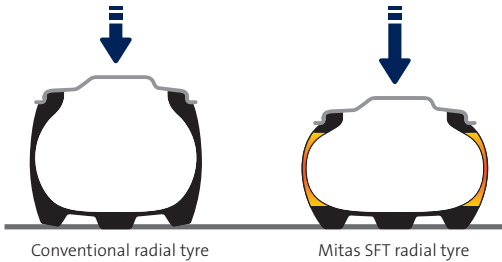

Conventional radial tyre

Mitas SFT radial tyre

Flexible sidewalls deliver maximum load capacity at the lowest possible inflation pressures for better traction and optimum soil protection, even with the heaviest equipment.



Super Flexion Tyre SFT

Technical data and load capacities

Tyre size	Service description LI/SS	Rims * (permitted)	Section width (mm)	Overall diameter (mm)	Loaded static radius (mm)	Rolling circumference (mm)	Speed radius index	
1000/50 R 25	178 A8 (172 D)	36.0 TH 36.0 VA	1 020	1 655	740	4 930	750	
1000/50 R 25	175 D (178 A8)	36.0 TH 36.0 VA	1 020 1 020	1 655	740	4 930	750	
620/75 R 26	166 A8 (166 B)	DW 20 B	625	1 590	689	4 660	750	
750/65 R 26	166 D (169 A8)	DW 23 B DW 25 B	738 758	1 620	720	4 800	750	
540/65 R 28	142 D (145 A8)	W 16 L W 18 L W 15 L	540 560 540	1 414	627	4 210	675	
600/65 R 28	154 D (157 A8)	W 18 L DW 20 B	606 626	1 494	664	4 444	700	
600/70 R 28	157 D (160 A8)	W 18 L DW 20 B	627 647	1 574	696	4 660	725	
600/70 R 28	161 D (164 A8)	W 18 L DW 20 B	630 650	1 578	698	4 670	725	
540/65 R 30	150 D (153 A8)	W 16 L W 18 L W 15 L	548 558 540	1 487	668	4 435	700	

SFT



	Tyre load capacity (kg) at tyre pressure (bar)											Speed (km/h)
	0.4	0.6	0.8	1.0	1.2	1.4	1.6	2.0	2.4	2.8	3.2	
			3 470	3 905	4 355	4 790	5 355	5 735	6 300		65	
			3 430	3 855	4 340	4 835	5 320	5 950	6 370	7 000	50	
			3 830	4 250	4 780	5 270	5 800	6 445	6 900	7 500	40	
			4 025	4 460	5 020	5 540	6 095	6 765	7 245	7 935	30	
			4 550	5 045	5 675	6 265	6 890	7 650	8 190	8 970	10	
				3 940	4 365	4 835	5 300	5 885	6 300	6 900	65	
				4 135	4 585	5 075	5 565	6 180	6 615	7 245	50	
		3 335	3 830	4 315	4 780	5 295	5 800	6 445	6 900	7 500	40	
		3 500	4 025	4 530	5 020	5 560	6 095	6 765	7 245	7 935	30	
		3 955	4 550	5 125	5 675	6 285	6 890	7 650	8 190	8 970	10	
				2 835	3 190	3 545	3 875	4 280	4 500	4 995	5 300	50
				2 835	3 190	3 545	3 875	4 280	4 500	4 995	5 300	40
				2 655	3 035	3 415	3 795	4 145	4 580	4 815	5 345	30
				2 755	3 150	3 540	3 935	4 300	4 750	4 995	5 540	25
				3 050	3 490	3 925	4 360	4 765	5 265	5 535	6 140	20
				3 225	4 535	4 150	5 670	5 040	5 565	5 850	6 490	10
				3 605	3 895	4 155	4 375	4 875	5 300		65	
				3 445	3 785	4 090	4 360	4 595	5 120	5 565	50	
		3 200	3 595	3 950	4 265	4 545	4 750	5 340	5 800		40	
		3 360	3 775	4 150	4 480	4 775	5 030	5 605	6 095		30	
	3 535	4 090	4 595	5 050	5 455	5 815	6 125	6 825	7 420	7 950	10	
				2 210	2 385	2 530	2 650				65	
				2 320	2 505	2 655	2 785				50	
		1 960	2 200	2 420	2 615	2 770	2 900				40	
		2 060	2 315	2 540	2 745	2 910	3 050				30	
	2 165	2 505	2 815	3 095	3 340	3 545	3 710	3 975			10	
				2 605	2 815	2 995	3 150	3 490	3 750		65	
				2 735	2 955	3 145	3 310	3 665	3 940		50	
				2 595	2 855	3 080	3 280	3 450	3 820	4 125	40	
				2 425	2 995	3 235	3 445	3 625	4 010	4 315	30	
		2 555	2 955	3 320	3 650	3 940	4 195	4 410	4 885	5 250	10	
				2 900	3 175	3 380	3 550	3 900	4 125		65	
				2 730	3 045	3 335	3 730	4 095	4 330		50	
				2 505	2 850	3 175	3 700	3 875	4 270	4 500	40	
				2 630	2 990	3 335	3 885	4 085	4 485	4 745	30	
		2 730	3 200	3 640	4 060	4 450	4 730	4 970	5 460	5 775	10	
				2 900	3 175	3 380	3 550	3 900	4 125	4 625	65	
				2 730	3 045	3 335	3 550	3 730	4 095	4 330	50	
				2 505	2 850	3 175	3 700	3 875	4 270	4 500	5 065	40
				2 630	2 990	3 335	3 885	4 085	4 485	4 745	5 320	30
		2 730	3 200	3 640	4 060	4 450	4 730	4 970	5 460	5 775	10	
				2 280	2 465	2 605	2 725	3 080	3 350		65	
				2 180	2 395	2 585	2 735	2 860	3 235	3 520	50	
				2 020	2 270	2 495	2 695	3 000	3 375	3 650	40	
				2 125	2 385	2 620	2 830	3 000	3 135	3 545	30	
		2 235	2 585	2 905	3 190	3 450	3 650	3 815	4 315	4 690	10	

Super Flexion Tyre SFT (continued)

Technical data and load capacities

Tyre size	Service description LI/SS	Rims * (permitted)	Section width (mm)	Overall diameter (mm)	Loaded static radius (mm)	Rolling circumference (mm)	Speed radius index	
600/70 R 30	152 D (155 A8)	W 18 L DW 20 B	625 645	1 595	700	4 700	750	
620/75 R 30	163 D (166 A8)	W 20 B W 18 L W 21 B	605 585 615	1 700	745	5 010	800	
620/75 R 30	166 D (169 A8)	W 20 B W 18 L W 21 B	635 615 645	1 700	740	4 980	800	
710/55 R 30	159 D (162 A8)	DW 23 B	690	1 500	674	4 475	725	
710/60 R 30	162 D (165 A8)	DW 23 B	708	1 646	730	4 870	750	
750/55 R 30	162 D (165 A8)	DW 23 B	720	1 584	712	4 725	750	
800/70 R 32	175 A8 (172 B)	DW 25 B DW 27 B	762 784	1 932	845	5 630	925	
900/60 R 32	176 A8 (173 B)	DW 27 B DW 30 B	857 890	1 905	850	5 700	925	
900/60 R 32	181 A8 (178 B)	DW 27 B DW 30 B	857 890	1 910	850	5 700	925	

SFT



Tyre load capacity (kg) at tyre pressure (bar)												Speed (km/h)
0.4	0.6	0.8	1.0	1.2	1.4	1.6	2.0	2.4	2.8	3.2		
			2 985	3 270	3 430	3 550						65
			2 815	3 135	3 435	3 605	3 730					50
		2 575	2 935	3 270	3 585	3 755	3 875					40
		2 705	3 080	3 435	3 765	3 945	4 085					30
	2 810	3 295	3 750	4 180	4 580	4 805	4 970	5 325				10
			3 005	3 380	3 755	4 125	4 555	4 875				65
			3 155	3 550	3 940	4 330	4 780	5 120				50
		2 465	2 880	3 290	3 700	4 110	4 515	4 985	5 340			40
		2 590	3 025	3 455	3 885	4 315	4 745	5 235	5 605			30
	2 440	2 930	3 415	3 905	4 395	4 880	5 365	5 920	6 340	7 315		10
			3 005	3 380	3 755	4 125	4 555	4 875	5 300			65
			3 155	3 550	3 940	4 330	4 780	5 120	5 565			50
		2 465	2 880	3 290	3 700	4 110	4 515	4 985	5 340	5 800		40
		2 590	3 025	3 455	3 885	4 315	4 745	5 235	5 605	6 205		30
	2 440	2 930	3 415	3 905	4 395	4 880	5 365	5 920	6 340	7 540	8 700	10
			2 805	3 065	3 365	3 650	4 045	4 375				65
			2 945	3 220	3 530	3 835	4 250	4 595				50
		2 440	2 765	3 075	3 360	3 680	4 000	4 430	4 750			40
		2 560	2 905	3 230	3 525	3 865	4 200	4 655	5 030			30
	2 670	3 115	3 540	3 930	4 295	4 710	5 110	5 665	6 125	6 565		10
			3 035	3 315	3 605	3 875	4 385	4 750				65
			3 185	3 480	3 785	4 070	4 605	4 990				50
		2 635	2 990	3 325	3 630	3 945	4 250	4 800	5 150			40
		2 770	3 140	3 490	3 815	4 145	4 455	5 040	5 465			30
	2 885	3 370	3 825	4 250	4 645	5 045	5 425	6 135	6 650	7 125		10
			3 060	3 340	3 675	4 000	4 400	4 750				65
			3 210	3 510	3 860	4 200	4 620	4 990				50
		2 655	3 015	3 350	3 660	4 025	4 375	4 820	5 150			40
		2 790	3 165	3 515	3 845	4 225	4 600	5 060	5 465			30
	2 905	3 395	3 855	4 280	4 680	5 145	5 600	6 160	6 650	7 125		10
			4 180	4 575	5 010	5 450	5 965	6 300				50
			4 590	5 025	5 505	6 000	6 555	6 900				40
		3 815	4 235	4 915	5 380	5 895	6 420	7 015	7 385			30
		4 085	4 530	5 095	5 580	6 115	6 600	7 275	7 660			25
		4 235	4 700	5 650	6 180	6 775	7 380	8 060	8 485			20
		4 695	5 210	5 970	6 535	7 160	7 800	8 520	8 970	10 350		10
			4 250	4 650	5 020	5 450	5 950	6 500				50
			4 670	5 110	5 515	6 000	6 535	7 100				40
		3 890	4 315	5 000	5 465	5 900	6 420	6 995	7 595			30
		4 165	4 615	5 185	5 670	6 120	6 660	7 255	7 880			25
		4 320	4 790	5 745	6 285	6 785	7 380	8 040	8 735			20
		4 790	5 305	6 070	6 640	7 170	7 800	8 495	9 230	10 650		10
			4 250	4 650	5 020	5 450	5 950	6 500	7 025	7 500		50
			4 670	5 110	5 515	6 000	6 535	7 100	7 720	8 250		40
		3 890	4 315	5 000	5 465	5 900	6 420	6 995	7 595	8 260	8 830	30
		4 165	4 615	5 185	5 670	6 120	6 660	7 255	7 880	8 570	9 160	25
		4 320	4 790	5 745	6 285	6 785	7 380	8 040	8 735	9 495	10 150	20
		4 790	5 305	6 070	6 640	7 170	7 800	8 495	9 230	10 810	11 550	10

Super Flexion Tyre SFT (continued)

Technical data and load capacities

Tyre size	Service description LI/SS	Rims * (permitted)	Section width (mm)	Overall diameter (mm)	Loaded static radius (mm)	Rolling circumference (mm)	Speed radius index	
900/70 R 32	188 A8 (185 B)	DW 27 B DW 30 B	895 925	2 050	896	6 050	975	
1050/50 R 32	178 A8 (178 B)	36.00 VA	1 015	1 890	855	5 640	875	
1250/50 R 32	188 A8 (185 B)	44" 40"	1 220 1 180	2 020	890	6 000	975	
1250/50 R 32	194 A8 (191 B)	44" 40"	1 220 1 180	2 020	890	6 000	975	
650/60 R 34	159 D (162 A8)	DW 20 B DW 21 B DW 23 B	650 660 680	1 638	740	4 935	775	
650/65 R 34	161 D (164 A8)	DW 20 B DW 21 B DW 23 B	664 674 694	1 719	769	5 116	825	
710/60 R 34	164 D (167 A8)	DW 23 B	700	1 700	770	5 060	825	
650/65 R 38	157 D (160 A8)	W 18 L DW 20 B DW 21 B	645 660 670	1 828	810	5 445	875	

SFT



	Tyre load capacity (kg) at tyre pressure (bar)											Speed (km/h)	
	0.4	0.6	0.8	1.0	1.2	1.4	1.6	2.0	2.4	2.8	3.2		
				5 055	5 530	6 060	6 700	7 215	7 750	8 415	9 250	50	
		4 615	5 120	5 555	6 080	6 660	7 300	7 925	8 500	9 250	10 000	40	
		4 940	5 480	5 945	6 505	7 125	7 810	8 480	9 095	9 895	10 700	30	
		5 125	5 685	6 165	6 750	7 395	8 105	8 800	9 435	10 265	11 100	25	
		5 675	6 300	6 830	7 475	8 195	8 980	9 750	10 455	11 375	12 300	20	
		6 000	6 660	7 220	7 905	8 660	9 490	10 305	11 050	12 025	13 000	10	
				5 045	5 515	5 955	6 500	7 055	7 500			50	
		4 200	4 655	5 045	5 515	5 955	6 500	7 055	7 500			40	
		4 495	4 985	5 395	5 900	6 370	6 955	7 550	8 025			30	
		4 665	5 170	5 595	6 120	6 610	7 215	7 830	8 325			25	
		5 170	5 730	6 200	6 785	7 320	7 995	8 680	9 225			20	
		5 465	6 055	6 555	7 170	7 740	8 450	9 175	9 750	11 250		10	
				5 020	5 655	6 265	6 960	7 750	8 500	9 250		50	
		4 730	5 515	6 210	6 885	7 650	8 500	9 340	10 000			40	
		5 060	5 905	6 645	7 265	8 185	9 095	9 995	10 700			30	
		5 250	6 125	6 895	7 640	8 490	9 435	10 370	11 100			25	
		5 815	6 785	7 640	8 470	9 410	10 455	11 490	12 300			20	
		6 620	7 725	8 695	9 640	10 710	11 900	13 075	14 000			10	
				5 020	5 655	6 265	6 960	7 750	8 500	9 250	10 040	10 900	50
		4 730	5 515	6 210	6 885	7 650	8 500	9 340	10 000	11 035	11 800	40	
		5 060	5 905	6 645	7 265	8 185	9 095	9 995	10 700	11 805	12 625	30	
		5 250	6 125	6 895	7 640	8 490	9 435	10 370	11 100	12 245	13 100	25	
		5 815	6 785	7 640	8 470	9 410	10 455	11 490	12 300	13 570	14 515	20	
		6 620	7 725	8 695	9 640	10 710	11 900	13 075	14 000	15 445	16 520	10	
				2 795	3 055	3 355	3 650	4 040	4 375			65	
				2 935	3 210	3 525	3 835	4 240	4 595			50	
		2 430	2 755	3 060	3 345	3 675	4 000	4 420	4 750			40	
		2 550	2 895	3 215	3 515	3 860	4 200	4 645	5 030			30	
	2 660	3 105	3 525	3 915	4 280	4 700	5 110	5 655	6 125	6 565		10	
				3 215	3 475	3 690	3 875	4 305	4 625			65	
			3 070	3 375	3 645	3 875	4 070	4 520	4 855			50	
		2 850	3 205	3 520	3 800	4 040	4 250	4 710	5 000			40	
		2 995	3 365	3 695	3 995	4 245	4 455	4 950	5 320			30	
	3 150	3 645	4 095	4 500	4 860	5 165	5 425	6 025	6 475	6 940		10	
				3 205	3 505	3 820	4 125	4 625	5 000			65	
			3 030	3 365	3 680	4 010	4 300	4 855	5 250			50	
		2 785	3 160	3 510	3 835	4 185	4 500	5 060	5 450			40	
		2 925	3 320	3 685	4 030	4 395	4 745	5 315	5 750			30	
	3 050	3 560	4 040	4 490	4 905	5 350	5 775	6 470	7 000	7 500		10	
				3 380	3 655	3 905	4 125					65	
			3 230	3 550	3 835	4 100	4 330					50	
		3 000	3 370	3 705	4 000	4 275	4 500					40	
		3 150	3 540	3 890	4 200	4 490	4 745					30	
	3 315	3 835	4 310	4 735	5 115	5 465	5 775	6 190				10	

Super Flexion Tyre SFT (continued)

Technical data and load capacities

Tyre size	Service description LI/SS	Rims * (permitted)	Section width (mm)	Overall diameter (mm)	Loaded static radius (mm)	Rolling circumference (mm)	Speed radius index
650/75 R 38	169 D (172 A8)	DW 21 B DW 20 B DW 23 B	667 657 687	1 944	872	5 795	925
650/85 R 38	173 D (176 A8)	DW 23 B DW 20 B DW 21 B	720 688 699	2 070	920	6 130	975
710/70 R 38	166 D (169 A8)	DW 23 B DW 25 B	736 756	1 958	870	5 780	925
710/70 R 38	171 D (174 A8)	DW 23 B DW 25 B	736 756	1 958	870	5 780	925
800/70 R 38	173 D (176 A8)	DW 25 B DW 27 B	765 787	2 052	911	6 090	975
800/70 R 38	178 D (181 A8)	DW 25 B DW 27 B	765 787	2 052	911	6 090	975
900/60 R 38	172 D (175 A8)	DW 27 B DW 30 B	870 900	2 060	918	6 115	975
900/60 R 38	178 D (181 A8)	DW 27 B DW 30 B	870 900	2 060	918	6 115	975
580/85 R 42	163 D (166 A8)	W 18 L DW 20 B DW 21 B	567 587 597	2 045	920	6 100	975

SFT



Tyre load capacity (kg) at tyre pressure (bar)												Speed (km/h)
0.4	0.6	0.8	1.0	1.2	1.4	1.6	2.0	2.4	2.8	3.2		
			3 990	4 375	4 645	4 875	5 425	5 800				65
		3 445	3 760	4 190	4 590	4 880	5 120	5 695	6 090			50
		3 620	3 920	4 370	4 790	5 085	5 300	5 940	6 300			40
		3 760	4 120	4 590	5 030	5 340	5 605	6 235	6 670			30
		4 405	5 015	5 585	6 125	6 505	6 825	7 590	8 120	8 700		10
			4 465	4 895	5 195	5 450	6 075	6 500				65
		3 855	4 210	4 690	5 140	5 455	5 725	6 375	6 825			50
		4 050	4 390	4 890	5 360	5 690	6 000	6 650	7 100			40
		4 210	4 610	5 135	5 630	5 975	6 270	6 985	7 475			30
		4 930	5 610	6 250	6 855	7 275	7 630	8 500	9 100	9 750		10
			4 305	4 720	5 030	5 300						65
		3 715	4 055	4 520	4 955	5 280	5 565					50
		3 905	4 230	4 715	5 170	5 510	5 800					40
		4 055	4 445	4 950	5 425	5 785	6 095					30
		4 750	5 410	6 025	6 605	7 045	7 420	7 950				10
			4 305	4 720	5 030	5 300	5 805	6 150				65
		3 715	4 055	4 520	4 955	5 280	5 565	6 095	6 460			50
		3 905	4 230	4 715	5 170	5 510	5 800	6 355	6 735			40
		4 055	4 445	4 950	5 425	5 785	6 095	6 675	7 075			30
		4 750	5 410	6 025	6 605	7 045	7 420	8 125	8 610	9 225		10
			5 190	5 690	6 070	6 400						65
		4 480	4 890	5 450	5 975	6 375	6 720	7 035	7 500			50
		4 705	5 100	5 685	6 230	6 650	7 010					40
		4 890	5 360	5 970	6 545	6 980	7 360	7 660				30
		5 730	6 525	7 270	7 965	8 500	8 960	9 850				10
			5 190	5 690	6 070	6 400	7 035	7 500				65
		4 480	4 890	5 450	5 975	6 375	6 720	7 390	7 875			50
		4 705	5 100	5 685	6 230	6 650	7 010	7 705	8 250			40
		4 890	5 360	5 970	6 545	6 980	7 360	8 090	8 625			30
		5 730	6 525	7 270	7 965	8 500	8 960	9 850	10 500	11 250		10
			4 875	5 325	5 825	6 300						65
		4 235	4 610	5 120	5 595	6 115	6 615	7 035	7 335			50
		4 450	4 805	5 340	5 835	6 375	6 900					40
		4 635	5 050	5 605	6 125	6 695	7 245	7 820	8 335			30
		5 415	6 145	6 825	7 460	8 155	8 820	9 450				10
			4 875	5 325	5 825	6 300	6 985	7 500				65
		4 235	4 610	5 120	5 595	6 115	6 615	7 335	7 875			50
		4 450	4 805	5 340	5 835	6 375	6 900	7 650	8 250			40
		4 635	5 050	5 605	6 125	6 695	7 245	8 035	8 625			30
		5 415	6 145	6 825	7 460	8 155	8 820	9 780	10 500	11 250		10
			3 605	3 945	4 405	4 875						65
		3 125	3 785	4 140	4 630	5 120	5 605	6 075	6 540			50
		3 285	3 550	3 950	4 320	4 825	5 300					40
		3 420	3 730	4 145	4 535	5 070	5 605	6 075	6 540			30
		3 995	4 540	5 050	5 520	6 170	6 825	7 260				10

Super Flexion Tyre SFT (continued)

Technical data and load capacities

Tyre size	Service description LI/SS	Rims * (permitted)	Section width (mm)	Overall diameter (mm)	Loaded static radius (mm)	Rolling circumference (mm)	Speed radius index
580/85 R 42	168 D (171 A8)	W 18 L DW 20 B DW 21 B	590 610 620	2 050	920	6 100	975
650/75 R 42	165 D (168 A8)	DW 21 B DW 20 B DW 23 B	650 640 670	2 035	905	6 090	975
680/80 R 42	180 D (183 A8)	DW 21 B DW 20 B DW 23 B	660 650 680	2 160	965	6 400	1 025
710/70 R 42	173 D (176 A8)	DW 23 B DW 25 B	731 751	2 070	935	6 150	975
710/75 R 42	175 D (178 A8)	DW 23 B DW 25 B	751 771	2 171	971	6 460	1 025
900/60 R 42	180 D (183 A8)	DW 27 B DW 30 B	860 890	2 150	970	6 440	1 025
710/65 R 46	174 D (177 A8)	DW 23 B DW 25 B	700 720	2 090	945	6 220	1 025
IF 710/65 R 46	183 D	DW 25 B DW 27 B	715 735	2 090	945	6 220	1 025

* Further admissible rims on request

Load values for 0.4 bar and 0.6 bar are for calculating dual and triple load values only. 30 km/h (up to 40 km/h) load values also apply for low-speed high-torque field work.

For plowing with single driven tyres in the furrow, a minimum inflation pressure of 0.8 bar is required.

For intensive road transport at 65/50/40/30 km/h the pressure must be increased by 0.4 bar. Maximum inflation pressure should never be exceeded.

All load values are valid for ground slopes up to and including 20% (11°). When operating on slopes greater than 20%, please, contact the producer.

Tubeless tyres – may be used with a tube.

SFT



Tyre load capacity (kg) at tyre pressure (bar)												Speed (km/h)
0.4	0.6	0.8	1.0	1.2	1.4	1.6	2.0	2.4	2.8	3.2		
			3 605	3 945	4 405	4 875	5 275	5 600				65
		3 125	3 785	4 140	4 630	5 120	5 540	5 880				50
		3 285	3 950	4 320	4 825	5 300	5 775	6 150				40
		3 730	4 145	4 535	5 070	5 605	6 065	6 440				30
	3 420	3 995	4 540	5 050	5 520	6 170	6 825	7 385	7 840			10
			4 175	4 575	4 885	5 150						65
			4 380	4 805	5 125	5 410						50
		3 605	4 100	4 570	5 010	5 345	5 600					40
		3 785	4 305	4 800	5 260	5 615	5 925					30
	3 935	4 605	5 245	5 845	6 405	6 835	7 210	7 725				10
			4 495	4 920	5 390	5 800	6 415	6 900	7 490	8 000		65
			4 720	5 165	5 660	6 090	6 735	7 245	7 865	8 400		50
		4 090	4 540	4 920	5 385	5 900	6 350	7 025	7 555	8 200	8 760	40
		4 295	4 765	5 170	5 660	6 200	6 670	7 600	7 935	8 615	9 200	30
	4 150	4 855	5 390	5 845	6 400	7 010	7 540	8 345	8 970	9 735	10 400	10
			4 500	4 935	5 285	5 600	6 100	6 500				65
			4 725	5 180	5 550	5 880	6 405	6 825				50
		3 885	4 425	4 930	5 405	5 790	6 150	6 680	7 100			40
		4 080	4 645	5 180	5 675	6 080	6 440	7 015	7 475			30
	4 240	4 970	5 655	6 305	6 910	7 400	7 840	8 540	9 100	9 750		10
			4 785	5 245	5 640	6 000	6 480	6 900				65
			5 025	5 510	5 925	6 300	6 805	7 245				50
		4 130	4 700	5 240	5 745	6 175	6 500	7 095	7 500			40
		4 340	4 940	5 505	6 030	6 490	6 900	7 450	7 935			30
	4 510	5 280	6 010	6 700	7 345	7 900	8 400	9 070	9 660	10 350		10
			5 095	5 565	6 135	6 700	7 370	8 000				65
			5 350	5 845	6 445	7 035	7 735	8 400				50
		4 425	5 020	5 575	6 095	6 720	7 335	8 070	8 750			40
		4 645	5 270	5 855	6 400	7 055	7 705	8 475	9 200			30
	4 840	5 655	6 420	7 130	7 790	8 590	9 380	10 315	11 200	12 000		10
			4 235	4 575	4 880	5 150	5 695	6 150	6 700			65
			4 445	4 805	5 125	5 410	5 980	6 460	7 035			50
		3 755	4 220	4 640	5 010	5 345	5 640	6 235	6 700	7 300		40
		3 945	4 430	4 870	5 260	5 615	5 925	6 550	7 075	7 705		30
	4 150	4 800	5 395	5 930	6 405	6 835	7 210	7 970	8 610	9 380		10
			4 625	5 150	5 675	6 150	6 800	7 300	8 000	8 750		65
			4 070	4 530	4 995	5 410	5 985	6 425	7 040	7 700		65 Dual

Tractor Radial Tyres | SST

kW	22	44	66	88	110	132	150	162	184	>220
hp	30	60	90	120	150	180	200	220	250	>300



SST



Silent Speed Tyre (SST)

Fast, powerful and impressively quiet



Noise reduction of up to 6 dB(A) in the cab maximises concentration and minimises stress.



New casing construction ensures a **cost saving through reduced rolling resistance, long tyre life and high damage resistance.**



Highest levels of productivity achieved through the excellent characteristics of the low profile and casing.



Highest possible sustained speed capability of up to 70 km/h.

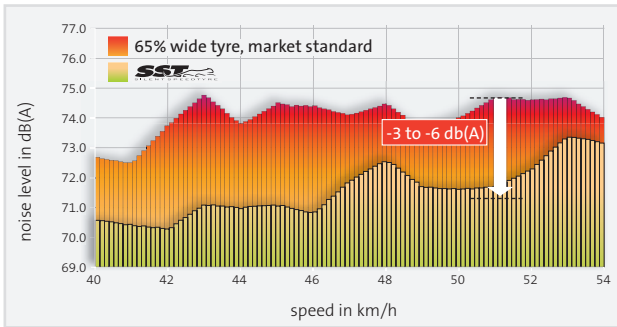

The Silent Speed Tyre SST traction tyre prevents the occurrence of the so-called “booming noise effect”. The SST reduces the noise level in the driver’s cab by 3 to 6 dB(A) compared with conventional rear axle tyres.



Silent Speed Tyre SST

Technical data and load capacities

Tyre size	Service description LI/SS	Rims * (permitted)	Section width (mm)	Overall diameter (mm)	Loaded static radius (mm)	Rolling circumference (mm)	Speed radius index
600/65 R 38	153 D (156 A8)	W 18 L DW 18 L W 16 L	591 591 571	1 746	782	5 215	825
650/65 R 38	157 D (160 A8)	W 18 L DW 20 B	623 643	1 822	810	5 420	875
710/70 R 38	171 D (168 E)	DW 23 A DW 25 A	740 750	1 954	870	5 780	925
650/65 R 42	165 D (168 A8)	W 18 L DW 20 B	616 636	1 930	870	5 790	925
710/70 R 42	173 D (170 E)	DW 23 A DW 25 A	735 755	2 056	935	6 150	975
710/75 R 42	175 D (172 E)	DW 23 A DW 25 A	740 760	2 160	970	6 460	1 025

* Further admissible rims on request

Load values for 0.4 bar and 0.6 bar are for calculating dual and triple load values only.
30 km/h (up to 40 km/h) load values also apply for low-speed high-torque field work.

For plowing with single driven tyres in the furrow, a minimum inflation pressure of 0.8 bar is required.

For intensive road transport at 65/50/40/30 km/h the pressure must be increased by 0.4 bar. Maximum inflation pressure should never be exceeded.

All load values are valid for ground slopes up to and including 20% (11°). When operating on slopes greater than 20%, please, contact the producer.

Tubeless tyres – may be used with a tube.

SST



	Tyre load capacity (kg) at tyre pressure (bar)										Speed (km/h)
	0.4	0.6	0.8	1.0	1.2	1.4	1.6	2.0	2.4	3.0	
2 655		2 425 2 545 3 100	2 640 2 755 2 890 3 520	2 795 2 935 3 060 3 210 3 910	3 050 3 205 3 340 3 510 4 275	3 355 3 525 3 675 3 860 4 695	3 650 3 835 4 000 4 200 5 110	5 475			65 50 40 30 10
3 000		2 740 2 880 3 505	2 985 3 110 3 270 3 980	3 155 3 315 3 455 3 630 4 420	3 450 3 625 3 780 3 970 4 830	3 790 3 980 4 150 4 360 5 310	4 125 4 330 4 500 4 745 5 775	6 190			65 50 40 30 10
4 055		3 715 3 905 4 750	4 055 4 230 4 445 5 410	4 305 4 520 4 715 4 950 6 025	4 295 4 720 4 955 5 170 5 425 6 605	4 575 5 030 5 280 5 510 5 785 7 045	4 825 5 300 5 565 5 800 6 095 7 420	5 285 5 805 6 095 6 355 6 675 8 125	5 595 6 150 6 460 6 700 7 075 8 610	9 225	70 65 50 40 30 10
3 145		2 875 3 015 3 675	3 125 3 260 3 425 4 170	3 310 3 475 3 625 3 805 4 635	3 615 3 795 3 960 4 160 5 065	3 940 4 140 4 315 4 530 5 515	4 250 4 465 4 625 4 890 5 950	4 765 5 005 5 220 5 480 6 675	5 150 5 410 5 600 5 925 7 210	7 725	65 50 40 30 10
4 240		3 885 4 080 4 970	4 245 4 425 4 645 5 655	4 095 4 500 4 725 4 930 5 180 6 305	4 490 4 935 5 180 5 405 5 675 6 910	4 810 5 285 5 550 5 790 6 080 7 400	5 100 5 600 5 880 6 150 6 440 7 840	5 550 6 100 6 405 6 680 7 015 8 540	6 000 6 500 6 825 7 100 7 475 9 100	9 750	70 65 50 40 30 10
4 510		4 130 4 340 5 280	4 510 4 700 4 940 6 010	4 355 4 785 5 025 5 240 5 505 6 700	4 775 5 245 5 510 5 745 6 030 7 345	5 130 5 640 5 925 6 175 6 490 7 900	5 460 6 000 6 300 6 500 6 900 8 400	5 900 6 480 6 805 7 095 7 450 9 070	6 300 6 900 7 245 7 500 7 935 9 660	10 350	70 65 50 40 30 10

Tractor Radial Tyres | AC 65

kW	22	44	66	88	110	132	150	162	184	>220
hp	30	60	90	120	150	180	200	220	250	>300



AC 65



AC 65

Versatile wide tyre that delivers efficiency in field applications and in transport



Extremely economical thanks to very good traction and low-wear tread compound.



Very high load-carrying capacity through large volume of air.



Very gentle ground handling thanks to a very large contact patch and exceptional load-carrying capacities.



Greater operator comfort at road speeds as high as 65 km/h.



Standard tyre



Wide tyre AC 65

The very large contact patch permits high traction and gentle ground handling, even with heavy equipment.



AC 65

Technical data and load capacities

Tyre size	Service description LI/SS	Rims * (permitted)	Section width (mm)	Overall diameter (mm)	Loaded static radius (mm)	Rolling circumference (mm)	Speed radius index	
320/65 R 16	117 D (120 A8)	W 10 W 11 W 9	316 326 310	844	373	2 497	390	
420/65 R 20¹⁾	125 D (128 A8)	W 13 W 12 W 11	408 398 388	1 050	469	3 146	500	
420/65 R 20	125 D (128 A8)	W 13 W 12 W 11	415 405 395	1 050	469	3 146	500	
440/65 R 24	128 D (131 A8)	W 14 L W 13 W 12	445 435 425	1 196	543	3 585	575	
480/65 R 24	133 D (136 A8)	W 15 L W 14 L W 13	473 463 453	1 256	570	3 764	600	
540/65 R 24	140 D (143 A8)	W 16 L W 18 L W 15 L	523 543 513	1 317	590	3 922	625	
540/65 R 24	146 D (149 A8)	W 16 L W 18 L W 15 L	523 543 513	1 317	590	3 922	625	
440/65 R 28	131 D (134 A8)	W 14 L W 13 W 12	447 437 427	1 292	594	3 896	625	

¹⁾ Tread pattern AC 65 N



AC 65

	Tyre load capacity (kg) at tyre pressure (bar)										Speed (km/h)
	0.4	0.6	0.8	1.0	1.2	1.4	1.6	2.0	2.4	3.0	
625		585 615 750	655 685 715 875	715 750 780 820 1 000	800 840 880 920 1 125	890 935 975 1 020 1 245	975 1 025 1 060 1 120 1 365	1 135 1 195 1 245 1 305 1 590	1 285 1 350 1 400 1 480 1 800	1 930	65 50 40 30 10
1 130		1 045 1 095 1 335	1 145 1 195 1 255 1 530	1 225 1 285 1 340 1 410 1 715	1 355 1 420 1 480 1 555 1 895	1 500 1 575 1 645 1 725 2 100	1 650 1 735 1 800 1 900 2 310	2 475			65 50 40 30 10
1 130		1 045 1 095 1 335	1 145 1 195 1 255 1 530	1 225 1 285 1 340 1 410 1 715	1 355 1 420 1 480 1 555 1 895	1 500 1 575 1 645 1 725 2 100	1 650 1 735 1 800 1 900 2 310	2 475			65 50 40 30 10
1 330		1 215 1 280 1 555	1 325 1 380 1 450 1 765	1 400 1 470 1 535 1 610 1 960	1 530 1 610 1 675 1 760 2 145	1 670 1 750 1 830 1 920 2 335	1 800 1 890 1 950 2 070 2 520	2 700			65 50 40 30 10
1 525		1 395 1 465 1 780	1 515 1 580 1 660 2 020	1 605 1 685 1 755 1 845 2 245	1 755 1 840 1 920 2 015 2 455	1 910 2 005 2 090 2 195 2 675	2 060 2 165 2 240 2 370 2 885	3 090			65 50 40 30 10
1 835		1 675 1 760 2 140	1 825 1 900 1 995 2 430	1 930 2 025 2 115 2 220 2 700	2 110 2 215 2 310 2 425 2 950	2 310 2 425 2 525 2 655 3 230	2 500 2 625 2 725 2 875 3 500	3 750			65 50 40 30 10
1 835		1 675 1 760 2 140	1 825 1 900 1 995 2 430	1 930 2 025 2 115 2 220 2 700	2 110 2 215 2 310 2 425 2 950	2 310 2 425 2 525 2 655 3 230	2 500 2 625 2 740 2 875 3 500	2 780 2 915 3 040 3 195 3 890	3 000 3 150 3 250 3 450 4 200	4 500	65 50 40 30 10
1 430		1 305 1 375 1 670	1 425 1 485 1 560 1 895	1 505 1 580 1 650 1 730 2 110	1 645 1 725 1 800 1 890 2 305	1 800 1 890 1 970 2 070 2 520	1 950 2 050 2 120 2 245 2 730	2 925			65 50 40 30 10

AC 65 (continued)

Technical data and load capacities

Tyre size	Service description LI/SS	Rims * (permitted)	Section width (mm)	Overall diameter (mm)	Loaded static radius (mm)	Rolling circumference (mm)	Speed radius index
480/65 R 28	136 D (139 A8)	W 15 L W 14 L W 13	475 465 455	1 355	616	4 064	650
540/65 R 28	142 D (145 A8)	W 16 L W 18 L W 15 L	530 550 520	1 410	624	4 145	675
600/65 R 28	147 D (150 A8)	W 18 L DW 20 B W 16 L	590 610 570	1 485	661	4 411	700
540/65 R 30	150 D (153 A8)	W 16 L W 18 L W 15 L	526 546 516	1 485	664	4 419	700
600/65 R 30	149 D (152 A8)	W 18 L DW 20 B W 16 L	590 610 570	1 549	687	4 591	725
540/65 R 34	145 D (148 A8)	W 16 L W 18 L W 15 L	526 546 516	1 580	709	4 709	750
600/65 R 34	151 D (154 A8)	W 18 L DW 20 B W 16 L	592 612 572	1 648	737	4 904	775
600/65 R 34	157 D (160 A8)	W 18 L DW 20 B W 16 L	592 612 572	1 648	737	4 904	775
540/65 R 38	147 D (150 A8)	W 16 L W 18 L W 15 L	517 537 507	1 678	760	5 023	800



AC 65

	Tyre load capacity (kg) at tyre pressure (bar)										Speed (km/h)
	0.4	0.6	0.8	1.0	1.2	1.4	1.6	2.0	2.4	3.0	
1 635		1 495 1 570 1 910	1 625 1 695 1 780 2 165	1 720 1 805 1 885 1 980 2 410	1 880 1 975 2 060 2 160 2 630	2 060 2 165 2 260 2 370 2 885	2 240 2 350 2 430 2 575 3 135	3 360			65 50 40 30 10
1 960		1 790 1 880 2 290	1 950 2 035 2 135 2 600	2 065 2 165 2 260 2 375 2 890	2 255 2 365 2 470 2 595 3 155	2 455 2 580 2 690 2 825 3 440	2 650 2 785 2 900 3 050 3 710	3 975			65 50 40 30 10
2 310		2 110 2 220 2 700	2 300 2 395 2 515 3 065	2 430 2 555 2 665 2 795 3 405	2 660 2 790 2 910 3 055 3 720	2 875 3 020 3 145 3 305 4 025	3 075 3 230 3 350 3 535 4 305	4 615			65 50 40 30 10
2 020		1 850 1 940 2 365	2 010 2 100 2 205 2 680	2 130 2 235 2 330 2 450 2 980	2 325 2 440 2 545 2 675 3 255	2 545 2 675 2 790 2 930 3 565	2 725 2 860 3 000 3 135 3 815	3 080 3 235 3 375 3 545 4 315	3 350 3 520 3 650 3 855	5 025	65 50 40 30 10
2 380		2 175 2 285 2 780	2 370 2 470 2 595 3 160	2 505 2 630 2 745 2 880 3 510	2 740 2 875 3 000 3 150 3 835	3 000 3 150 3 285 3 450 4 200	3 250 3 415 3 550 3 740 4 550	4 875			65 50 40 30 10
2 145		1 960 2 055 2 505	2 130 2 225 2 335 2 845	2 255 2 370 2 470 2 595 3 160	2 465 2 590 2 700 2 835 3 450	2 690 2 820 2 945 3 090 3 765	2 900 3 045 3 150 3 335 4 060	4 350			65 50 40 30 10
2 520		2 300 2 420 2 945	2 505 2 615 2 745 3 340	2 650 2 785 2 905 3 050 3 710	2 900 3 045 3 175 3 330 4 055	3 180 3 335 3 480 3 655 4 450	3 450 3 625 3 750 3 970 4 830	5 175			65 50 40 30 10
2 520		2 300 2 420 2 945	2 505 2 615 2 745 3 340	2 650 2 785 2 905 3 050 3 710	2 900 3 045 3 175 3 330 4 055	3 180 3 335 3 480 3 655 4 450	3 450 3 625 3 750 3 970 4 830	3 875 4 070 4 250 4 455 5 425	4 125 4 330 4 500 4 745 5 775	6 300	65 50 40 30 10
2 260		2 065 2 170 2 640	2 250 2 345 2 465 3 000	2 380 2 500 2 605 2 735 3 330	2 600 2 730 2 850 2 990 3 640	2 845 2 985 3 115 3 270 3 980	3 075 3 230 3 350 3 535 4 305	4 615			65 50 40 30 10

AC 65 (continued)

Technical data and load capacities

Tyre size	Service description LI/SS	Rims * (permitted)	Section width (mm)	Overall diameter (mm)	Loaded static radius (mm)	Rolling circumference (mm)	Speed radius index	
600/65 R 38	153 D (156 A8)	W 18 L DW 20 B W 16 L	590 610 570	1 759	792	5 251	825	
650/65 R 38	157 D (160 A8)	DW 20 B DW 21 B DW 18 L	638 648 618	1 828	810	5 416	875	
650/65 R 38	166 D (169 A8)	DW 20 B DW 21 B DW 18 L	640 650 620	1 840	828	5 461	875	
650/65 R 38	173 D (176 A8)	DW 20 B DW 21 B DW 18 L	See page 80					
710/70 R 38	166 D (169 A8)	DW 23 B DW 25 B	708 728	1 925	857	5 716	925	
650/65 R 42	165 D (168 A8)	DW 20 B DW 21 B DW 18 L	641 651 621	1 936	860	5 798	925	

* Further admissible rims on request

Load values for 0.4 bar and 0.6 bar are for calculating dual and triple load values only.
30 km/h (up to 40 km/h) load values also apply for low-speed high-torque field work.

For plowing with single driven tyres in the furrow, a minimum inflation pressure of 0.8 bar is required.

For intensive road transport at 65/50/40/30 km/h the pressure must be increased by 0.4 bar. Maximum inflation pressure should never be exceeded.

All load values are valid for ground slopes up to and including 20% (11°). When operating on slopes greater than 20%, please, contact the producer.

Tubeless tyres – may be used with a tube.



AC 65

	Tyre load capacity (kg) at tyre pressure (bar)										Speed (km/h)	
	0.4	0.6	0.8	1.0	1.2	1.4	1.6	2.0	2.4	3.0		
				2 795	3 050	3 355	3 650					65
			2 640	2 935	3 205	3 525	3 835					50
		2 425	2 755	3 060	3 340	3 675	4 000					40
		2 545	2 890	3 210	3 510	3 860	4 200					30
2 655		3 100	3 520	3 910	4 275	4 695	5 110	5 475				10
				3 155	3 450	3 790	4 125					65
			2 985	3 315	3 625	3 980	4 330					50
		2 740	3 110	3 455	3 780	4 150	4 500					40
		2 880	3 270	3 630	3 970	4 360	4 745					30
3 000		3 505	3 980	4 420	4 830	5 310	5 775	6 190				10
				3 155	3 450	3 790	4 125	4 530	4 875	(2,8 bar)		65
			2 985	3 315	3 625	3 980	4 330	4 760	5 120	5 300		50
		2 740	3 110	3 455	3 780	4 150	4 500	4 960	5 300	5 800		40
		2 880	3 270	3 630	3 970	4 360	4 745	5 210	5 605	6 095		30
3 000		3 505	3 980	4 420	4 830	5 310	5 775	6 345	6 825	7 420		10
				3 975	4 345	4 825	5 300					65
			3 755	4 175	4 565	5 065	5 565					50
		3 445	3 915	4 350	4 760	5 280	5 800					40
		3 620	4 110	4 570	5 000	5 550	6 095					30
3 765		4 405	5 005	5 565	6 085	6 755	7 420	7 950				10
				3 310	3 615	3 940	4 250	4 765	5 150			65
			3 125	3 475	3 795	4 140	4 465	5 005	5 410			50
		2 875	3 260	3 625	3 960	4 315	4 625	5 220	5 600			40
		3 015	3 425	3 805	4 160	4 530	4 890	5 480	5 925			30
3 145		3 675	4 170	4 635	5 065	5 515	5 950	6 675	7 210	7 725		10

Tractor Radial Tyres | HC 70

kW	22	44	66	88	110	132	162	191	>220
hp	30	60	90	120	150	180	220	260	>300



HC 70



HC 70

The all-round benchmark in the 70 series wide tyre segment with higher load capacities than conventional 70 series



Low operating costs thanks to minimised slip, plus gentle ground handling through high load capacity.



Comfortable, safe road performance, thanks to wide tyre shoulders.



Particularly **gentle handling of grassland** through rounded shoulder design and lug edges.

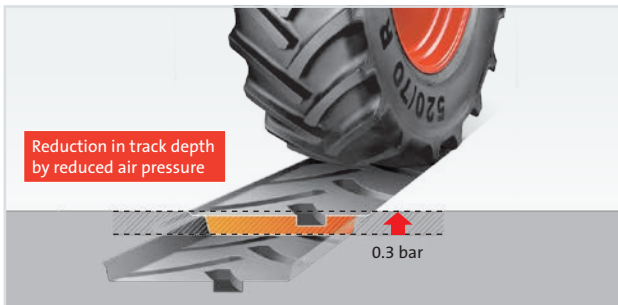

Low track depth and low operating costs, thanks to reduced inflation pressure and good traction.



HC 70

Technical data and load capacities

Tyre size	Service description L/SS	Rims * (permitted)	Section width (mm)	Overall diameter (mm)	Loaded static radius (mm)	Rolling circumference (mm)	Speed radius index
320/70 R 24	116 D (119 A8)	W 10 W 11 W 9	325 335 315	1 115	491	3 295	525
360/70 R 24	122 D (125 A8)	W 11 W 12 W 10	365 375 355	1 142	508	3 398	550
380/70 R 24	125 D (128 A8)	W 12 W 13 W 11	395 405 385	1 191	533	3 545	575
420/70 R 24	130 D (133 A8)	W 13 W 14 L W 12	443 453 433	1 245	552	3 695	600
480/70 R 24	138 D (141 A8)	W 15 L W 16 L W 14 L	502 512 492	1 320	574	3 896	625
380/70 R 28	127 D (130 A8)	W 12 W 13 W 11	395 405 385	1 292	576	3 850	625
420/70 R 28	133 D (136 A8)	W 13 W 14 L W 12	438 448 428	1 350	610	4 038	650
480/70 R 28	140 D (143 A8)	W 15 L W 16 L W 14 L	498 508 488	1 422	630	4 220	675
420/70 R 30	134 D (137 A8)	W 13 W 14 L W 12	433 443 423	1 392	622	4 150	675



HC 70

	Tyre load capacity (kg) at tyre pressure (bar)										Speed (km/h)
	0.6	0.8	1.0	1.2	1.4	1.6	2.0	2.4	2.8	3.2	
			945	1 035	1 140	1 250					65
		890	990	1 085	1 200	1 315					50
	820	930	1 035	1 190	1 250	1 360					40
	860	975	1 085	1 445	1 315	1 440					30
	1 045	1 190	1 320	2 170	1 600	1 750	1 875				10
			1 130	1 235	1 370	1 500					65
		1 065	1 185	1 295	1 435	1 575					50
	980	1 110	1 235	1 355	1 500	1 650					40
	1 030	1 170	1 300	1 420	1 575	1 725					30
	1 250	1 420	1 580	1 730	1 915	2 100	2 250				10
			1 225	1 340	1 495	1 650					65
		1 160	1 290	1 410	1 570	1 735					50
	1 065	1 210	1 345	1 470	1 640	1 800					40
	1 115	1 270	1 410	1 545	1 720	1 900					30
	1 360	1 545	1 720	1 880	2 095	2 310	2 475				10
			1 430	1 565	1 735	1 900					65
		1 350	1 505	1 645	1 820	1 995					50
	1 240	1 410	1 570	1 715	1 900	2 060					40
	1 305	1 480	1 645	1 800	1 995	2 185					30
	1 585	1 805	2 005	2 190	2 425	2 660	2 850				10
			1 765	1 930	2 145	2 360					65
		1 665	1 850	2 025	2 250	2 480					50
	1 530	1 735	1 930	2 110	2 350	2 575					40
	1 605	1 825	2 030	2 220	2 465	2 715					30
	1 955	2 220	2 470	2 700	3 000	3 305	3 540				10
			1 320	1 445	1 600	1 750					65
		1 245	1 385	1 515	1 675	1 840					50
	1 145	1 300	1 445	1 580	1 750	1 900					40
	1 200	1 365	1 520	1 660	1 835	2 015					30
	1 465	1 660	1 850	2 020	2 335	2 450	2 625				10
			1 535	1 680	1 870	2 060					65
		1 450	1 615	1 765	1 965	2 165					50
	1 335	1 515	1 685	1 840	2 050	2 240					40
	1 400	1 590	1 770	1 935	2 150	2 370					30
	1 705	1 935	2 150	2 355	2 620	2 885	3 090				10
			1 890	2 065	2 285	2 500					65
		1 780	2 980	2 170	2 395	2 625					50
	1 635	1 860	2 065	2 260	2 500	2 725					40
	1 720	1 950	2 170	2 375	2 625	2 875					30
	2 090	2 375	2 645	2 890	3 195	3 500	3 750				10
			1 590	1 735	1 930	2 120					65
		1 500	1 670	1 825	2 025	2 225					50
	1 375	1 565	1 740	1 905	2 110	2 300					40
	1 445	1 645	1 825	2 000	2 220	2 440					30
	1 760	2 000	2 225	2 430	2 700	2 970	3 180				10

HC 70 (continued)

Technical data and load capacities

Tyre size	Service description LI/SS	Rims * (permitted)	Section width (mm)	Overall diameter (mm)	Loaded static radius (mm)	Rolling circumference (mm)	Speed radius index
480/70 R 30	141 D (144 A8)	W 15 L W 16 L W 14 L	499 509 489	1 474	655	4 380	700
480/70 R 30	152 D (155 A8)	W 15 L W 16 L W 14 L	499 509 489	1 474	655	4 380	700
480/70 R 34	143 D (146 A8)	W 15 L W 16 L W 14 L	494 504 484	1 590	704	4 710	750
480/70 R 34	155 D (158 A8)	W 15 L W 16 L W 14 L	494 504 484	1 590	704	4 710	750
520/70 R 34	148 D (151 A8)	W 16 L W 18 L W 15 L	539 559 529	1 651	735	4 905	775
480/70 R 38	145 D (148 A8)	W 15 L W 16 L W 14 L	496 506 486	1 699	768	5 082	800
520/70 R 38	150 D (153 A8)	W 16 L W 18 L W 15 L	536 556 524	1 751	790	5 232	825
580/70 R 38	155 D (158 A8)	W 18 L	596	1 857	822	5 500	875

* Further admissible rims on request

Load values for 0.6 bar are for calculating dual and triple load values only.
30 km/h (up to 40 km/h) load values also apply for low-speed high-torque field work.
For plowing with single driven tyres in the furrow, a minimum inflation pressure of 0.8 bar is required.



HC 70

	Tyre load capacity (kg) at tyre pressure (bar)										Speed (km/h)
	0.6	0.8	1.0	1.2	1.4	1.6	2.0	2.4	2.8	3.2	
1 690 1 775 2 160	1 840 1 920 2 455	1 950 2 045 2 135 2 240 2 725	2 130 2 235 2 335 2 450 2 985	2 355 2 470 2 580 2 705 3 295	2 575 2 705 2 800 2 960 3 605		3 865				65 50 40 30 10
1 690 1 775 2 160	1 840 1 920 2 015 2 455	1 950 2 045 2 135 2 240 2 725	2 130 2 235 2 335 2 450 2 985	2 355 2 470 2 580 2 705 3 295	2 575 2 705 2 800 2 960 3 605	2 870 3 015 3 145 3 300 4 020	3 075 3 230 3 365 3 535 4 305	3 335 3 500 3 650 3 835 4 670	3 550 3 730 3 885 4 085 4 970	65 50 40 30 10	
1 790 1 880 2 290	1 950 2 035 2 135 2 600	2 065 2 170 2 265 2 375 2 895	2 260 2 375 2 475 2 600 3 165	2 495 2 620 2 730 2 870 3 490	2 725 2 860 3 000 3 135 3 815		4 090				65 50 40 30 10
1 790 1 880 2 290	1 950 2 035 2 135 2 600	2 065 2 170 2 265 2 375 2 895	2 260 2 375 2 475 2 600 3 165	2 495 2 620 2 730 2 870 3 490	2 725 2 860 3 000 3 135 3 815	3 000 3 150 3 250 3 450 4 200	3 250 3 415 3 550 3 740 4 550	3 550 3 730 3 875 4 085 4 970	3 875 4 070 4 250 4 455 5 425	65 50 40 30 10	
2 025 2 125 2 590	2 205 2 300 2 415 2 940	2 335 2 450 2 555 2 685 3 270	2 555 2 680 2 795 2 935 3 575	2 850 2 995 3 120 3 280 3 990	3 150 3 310 3 450 3 625 4 410		4 725				65 50 40 30 10
1 890 1 985 2 420	2 060 2 150 2 255 2 745	2 180 2 290 2 390 2 510 3 055	2 385 2 505 2 615 2 745 3 340	2 645 2 775 2 895 3 040 3 700	2 900 3 045 3 150 3 335 4 060		4 350				65 50 40 30 10
2 135 2 240 2 730	2 325 2 525 2 545 3 100	2 460 2 585 2 695 2 830 3 445	2 695 2 825 2 950 3 095 3 770	3 020 3 170 3 305 3 470 4 225	3 350 3 520 3 650 3 855 4 690		5 025				65 50 40 30 10
2 520 2 645 3 225	2 745 2 865 3 005 3 660	2 910 3 055 3 185 3 345 4 070	3 180 3 340 3 480 3 655 4 450	3 530 3 705 3 865 4 055 4 940	3 875 4 070 4 250 4 455 5 425		5 815				65 50 40 30 10

For intensive road transport at 65/50/40/30 km/h the pressure must be increased by 0.4 bar. Maximum inflation pressure should never be exceeded. All load values are valid for ground slopes up to and including 20% (11°). When operating on slopes greater than 20%, please, contact the producer. Tubeless tyres – may be used with a tube.

kW	22	44	66	88	110	132	150	162	184	>220
hp	30	60	90	120	150	180	200	220	250	>300



AC 70 T



AC 70 T

Wide traction tyre for heavy field work



Deep lugs provide greater traction **in the field.**



Outstanding self-cleaning between lugs reduces slip and improves pulling power.



Tremendous durability and outstanding traction make this tyre very economical.

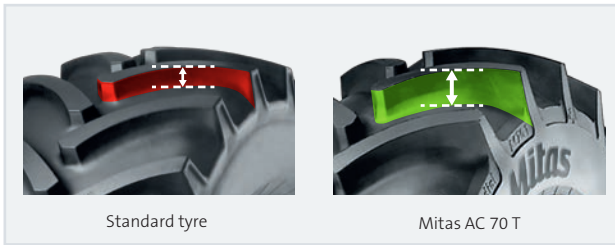

Standard tyre

Mitas AC 70 T

Deep high-grip lugs transmit traction, even on wet ground.



AC 70 T

Technical data and load capacities

Tyre size	Service description LI/SS	Rims * (permitted)	Section width (mm)	Overall diameter (mm)	Loaded static radius (mm)	Rolling circumference (mm)	Speed radius index
200/70 R 16	94 A8 (94 B)	W 6 W 8 W 7	198 218 208	691	311	2 050	330
240/70 R 16	104 A8 (104 B)	W 8 W 9 W 7	244 254 234	737	331	2 192	350
260/70 R 16	109 A8 (109 B)	W 8 W 9	261 271	770	345	2 290	360
280/70 R 16	112 A8 (112 B)	W 9 W 10 W 8	285 295 275	798	358	2 390	390
280/70 R 18	114 A8 (114 B)	W 9 W 10 W 8	280 290 270	852	383	2 545	410
260/70 R 20	113 A8 (113 B)	W 8 W 9 W 10	262 272 282	882	401	2 650	410
280/70 R 20	116 A8 (116 B)	W 9 W 10 W 8	276 286 266	906	411	2 725	425
300/70 R 20	110 A8 (110 B)	W 9 W 10	290 300	942	428	2 825	450
320/70 R 20	113 A8 (113 B)	W 10 W 11 W 9	320 330 310	972	441	2 916	475
360/70 R 20	120 A8 (120 B)	W 11 W 12 W 10	360 370 350	1 040	461	3 083	500



AC 70 T

	Tyre load capacity (kg) at tyre pressure (bar)									Speed (km/h)
	0.6	0.8	1.0	1.2	1.4	1.6	2.0	2.4	3.0	
			410	445	480	510	565	670		50
		375	410	445	480	510	565	670		40
	355	400	440	480	510	545	605	715		30
	435	485	535	580	625	660	735	870	1 005	10
			545	590	630	670	745	900		50
		495	545	590	630	670	745	900		40
	470	530	580	630	675	720	795	965		30
	570	640	705	765	820	870	965	1 170	1 350	10
			615	665	715	760	840	1 030		50
		560	615	665	715	760	840	1 030		40
	530	595	660	710	765	810	900	1 100		30
	645	725	800	865	930	985	1 095	1 340	1 545	10
			690	750	800	850	940	1 120		50
		625	690	750	800	850	940	1 120		40
	600	670	740	800	860	910	1 010	1 200		30
	720	815	900	970	1 040	1 110	1 230	1 460	1 680	10
			725	790	845	900	995	1 180		50
		660	725	790	845	900	995	1 180		40
	630	705	775	845	905	960	1 065	1 265		30
	765	860	945	1 025	1 100	1 165	1 295	1 535	1 770	10
			620	690	770	850	995	1 150		50
		550	620	690	770	850	995	1 150		40
	515	590	665	740	825	910	1 065	1 230		30
	670	775	870	965	1 080	1 190	1 395	1 610	1 725	10
			765	830	890	945	1 045	1 250		50
		695	765	830	890	945	1 045	1 250		40
	660	740	815	885	950	1 010	1 120	1 340		30
	805	900	995	1 075	1 155	1 230	1 360	1 625	1 875	10
			850	920	985	1 060				50
		770	850	920	985	1 060				40
	735	825	910	985	1 055	1 135				30
	890	1 000	1 105	1 200	1 280	1 380	1 590			10
			935	1 015	1 090	1 150				50
		850	935	1 015	1 090	1 150				40
	810	910	1 000	1 090	1 165	1 230				30
	985	1 105	1 220	1 320	1 420	1 495	1 725			10
			1 125	1 220	1 305	1 400				50
		1 020	1 125	1 220	1 305	1 400				40
	975	1 090	1 200	1 305	1 400	1 500				30
	1 180	1 330	1 460	1 585	1 700	1 820	2 100			10

AC 70 T (continued)

Technical data and load capacities

Tyre size	Service description LI/SS	Rims * (permitted)	Section width (mm)	Overall diameter (mm)	Loaded static radius (mm)	Rolling circumference (mm)	Speed radius index	
380/70 R 20	122 A8 (122 B)	W 12 W 13 W 11	383 393 373	1 074	478	3 195	525	
320/70 R 24	116 A8 (116 B)	W 10 W 11 W 9	320 330 310	1 095	505	3 276	525	
360/70 R 24	122 A8 (122 B)	W 11 W 12 W 10	360 370 350	1 150	516	3 426	550	
380/70 R 24	125 A8 (125 B)	W 12 W 13 W 11	387 397 377	1 187	538	3 508	575	
420/70 R 24	130 A8 (130 B)	W 13 W 14 L W 12	433 443 423	1 260	563	3 715	600	
380/70 R 28	127 A8 (127 B)	W 12 W 13 W 11	372 382 362	1 274	585	3 835	625	
420/70 R 28	133 A8 (133 B)	W 13 W 14 L W 12	420 430 410	1 350	609	3 988	650	
480/70 R 28	140 A8 (140 B)	W 15 L W 16 L W 14 L	480 490 470	1 415	630	4 206	675	
420/70 R 30	134 A8 (134 B)	W 13 W 14 L W 12	423 433 413	1 395	635	4 184	675	
480/70 R 30	141 A8 (141 B)	W 15 L W 16 L W 14 L	496 506 486	1 477	667	4 435	700	



AC 70 T

	Tyre load capacity (kg) at tyre pressure (bar)									Speed (km/h)
	0.6	0.8	1.0	1.2	1.4	1.6	2.0	2.4	3.0	
			1 220	1 325	1 420	1 500				50
		1 110	1 220	1 325	1 420	1 500				40
	1 060	1 190	1 310	1 420	1 520	1 605				30
	1 285	1 445	1 590	1 725	1 850	1 950	2 250			10
			1 020	1 110	1 190	1 250				50
		930	1 020	1 110	1 190	1 250				40
	885	995	1 095	1 185	1 270	1 340				30
	1 075	1 210	1 330	1 440	1 545	1 625	1 875			10
			1 220	1 325	1 420	1 500				50
		1 110	1 220	1 325	1 420	1 500				40
	1 055	1 185	1 305	1 415	1 520	1 605				30
	1 285	1 440	1 590	1 720	1 850	1 950	2 250			10
			1 330	1 440	1 540	1 650				50
		1 205	1 330	1 440	1 540	1 650				40
	1 150	1 290	1 420	1 540	1 650	1 765				30
	1 395	1 570	1 725	1 870	2 010	2 145	2 475			10
			1 550	1 680	1 800	1 900				50
		1 410	1 550	1 680	1 800	1 900				40
	1 340	1 505	1 660	1 800	1 930	2 030				30
	1 630	1 830	2 015	2 180	2 340	2 470	2 850			10
			1 430	1 550	1 660	1 750				50
		1 300	1 430	1 550	1 660	1 750				40
	1 235	1 390	1 530	1 660	1 775	1 875				30
	1 500	1 690	1 855	2 010	2 160	2 275	2 625			10
			1 660	1 800	1 930	2 060				50
		1 510	1 660	1 800	1 930	2 060				40
	1 440	1 620	1 780	1 930	2 070	2 200				30
	1 750	1 965	2 160	2 345	2 515	2 680	3 090			10
			2 040	2 215	2 375	2 500				50
		1 855	2 040	2 215	2 375	2 500				40
	1 770	1 985	2 185	2 370	2 540	2 680				30
	2 150	2 410	2 655	2 880	3 090	3 250	3 750			10
			1 720	1 865	2 000	2 120				50
		1 560	1 720	1 865	2 000	2 120				40
	1 490	1 670	1 840	1 995	2 140	2 270				30
	1 810	2 030	2 235	2 420	2 600	2 760	3 180			10
			2 060	2 240	2 420	2 575				50
		1 880	2 060	2 240	2 420	2 575				40
	1 820	2 010	2 200	2 400	2 590	2 760				30
	2 220	2 450	2 680	2 910	3 150	3 350	3 860			10

AC 70 T (continued)

Technical data and load capacities

Tyre size	Service description LI/SS	Rims * (permitted)	Section width (mm)	Overall diameter (mm)	Loaded static radius (mm)	Rolling circumference (mm)	Speed radius index
480/70 R 34	143 A8 (143 B)	W 15 L W 16 L W 14 L	490 500 480	1 575	710	4 686	750
520/70 R 34	148 A8 (148 B)	W 16 L W 18 L W 15 L	523 543 513	1 644	734	4 927	775
480/70 R 38	145 A8 (145 B)	W 15 L W 16 L W 14 L	487 497 477	1 687	767	5 065	800
520/70 R 38	150 A8 (150 B)	W 16 L W 18 L W 15 L	517 537 507	1 752	788	5 187	825
580/70 R 38	155 A8 (155 B)	W 18 L	570	1 829	819	5 442	875

* Further admissible rims on request

Load values for 0.6 bar are for calculating dual and triple load values only.

30 km/h (up to 40 km/h) load values also apply for low-speed high-torque field work.

For plowing with single driven tyres in the furrow, a minimum inflation pressure of 0.8 bar is required.

For intensive road transport at 50/40/30 km/h the pressure must be increased by 0.4 bar. Maximum inflation pressure should never be exceeded.

All load values are valid for ground slopes up to and including 20% (11°). When operating on slopes greater than 20%, please, contact the producer.

Tubeless tyres – may be used with a tube.



AC 70 T

	Tyre load capacity (kg) at tyre pressure (bar)									Speed (km/h)
	0.6	0.8	1.0	1.2	1.4	1.6	2.0	2.4	3.0	
1 935 2 350	2 030 2 170 2 640	2 235 2 235 2 390 2 905	2 425 2 425 2 595 3 150	2 600 2 600 2 780 3 380	2 725 2 725 2 915 3 545		4 090			50 40 30 10
2 185 2 655	2 295 2 455 2 980	2 525 2 525 2 700 3 285	2 740 2 740 2 930 3 560	2 935 2 935 3 140 3 820	3 150 3 150 3 370 4 095		4 725			50 40 30 10
2 045 2 480	2 145 2 290 2 790	2 360 2 360 2 525 3 070	2 560 2 560 2 740 3 330	2 745 2 745 2 935 3 570	2 900 2 900 3 100 3 770		4 350			50 40 30 10
2 300 2 800	2 380 2 550 3 090	2 600 2 600 2 780 3 380	2 830 2 830 3 030 3 680	3 060 3 060 3 270 3 980	3 350 3 350 3 590 4 360		5 030			50 40 30 10
2 720 3 310	2 855 3 060 3 715	3 145 3 145 3 365 4 090	3 410 3 410 3 650 4 435	3 655 3 655 3 915 4 755	3 875 3 875 4 145 5 040		5 815			50 40 30 10

kW	22	44	66	88	110	132	150	162	184	>220
hp	30	60	90	120	150	180	200	220	250	>300



AC 70 G



AC 70 G

Wide grassland tyre with optimum road characteristics



The large, wide lug areas **protect ground and plants**.



Stable, safe and comfortable running on the road, thanks to a wide tread area and large lug overlap in the tread centre.



Economical thanks to low wear.



Large, wide lug areas mean quiet running on the road and gentle driving over grassland.

- Conventional profile design
- AC 70 G Tread pattern



AC 70 G

Technical data and load capacities

Tyre size	Service description LI/SS	Rims * (permitted)	Section width (mm)	Overall diameter (mm)	Loaded static radius (mm)	Rolling circumference (mm)	Speed radius index
380/70 R 24	125 A8 (125 B)	W 12 W 13 W 11	385 395 375	1 190	540	3 524	575
420/70 R 24	130 A8 (130 B)	W 13 W 14 L W 12	435 445 425	1 248	561	3 708	600
480/70 R 24	138 A8 (138 B)	W 15 L W 16 L W 14 L	483 493 473	1 313	582	3 908	625
420/70 R 28	133 A8 (133 B)	W 13 W 14 L W 12	425 435 415	1 348	604	4 027	650
480/70 R 30	141 A8 (141 B)	W 15 L W 16 L W 14 L	485 495 475	1 462	653	4 345	700
480/70 R 34	143 A8 (143 B)	W 15 L W 16 L W 14 L	486 496 476	1 580	716	4 711	750
520/70 R 34	148 A8 (148 B)	W 16 L W 18 L W 15 L	539 559 529	1 649	740	4 930	775
520/70 R 38	150 A8 (150 B)	W 16 L W 18 L W 15 L	530 550 520	1 747	782	5 230	825

* Further admissible rims on request

Load values for 0.6 bar are for calculating dual and triple load values only.

30 km/h (up to 40 km/h) load values also apply for low-speed high-torque field work.

For plowing with single driven tyres in the furrow, a minimum inflation pressure of 0.8 bar is required.

For intensive road transport at 50/40/30 km/h the pressure must be increased by 0.4 bar. Maximum inflation pressure should never be exceeded.

All load values are valid for ground slopes up to and including 20% (11°). When operating on slopes greater than 20%, please, contact the producer.

Tubeless tyres – may be used with a tube.



AC 70 G

	Tyre load capacity (kg) at tyre pressure (bar)							Speed (km/h)
	0.6	0.8	1.0	1.2	1.4	1.6	2.0	
			1 325	1 440	1 540	1 650		50
		1 205	1 325	1 440	1 540	1 650		40
1 150		1 290	1 420	1 540	1 650	1 770		30
1 400		1 570	1 725	1 870	2 005	2 145	2 475	10
			1 550	1 680	1 800	1 900		50
		1 405	1 550	1 680	1 800	1 900		40
1 340		1 505	1 660	1 800	1 930	2 035		30
1 630		1 830	2 015	2 185	2 310	2 470	2 850	10
			1 905	2 065	2 215	2 360		50
		1 730	1 905	2 065	2 215	2 360		40
1 650		1 855	2 040	2 215	2 375	2 525		30
2 005		2 250	2 480	2 690	2 885	3 070	3 540	10
			1 660	1 805	1 930	2 060		50
		1 510	1 660	1 805	1 930	2 060		40
1 440		1 615	1 780	1 930	2 070	2 205		30
1 750		1 965	2 160	2 345	2 515	2 680	3 090	10
			2 105	2 285	2 450	2 575		50
		1 915	2 105	2 285	2 450	2 575		40
1 825		2 050	2 255	2 445	2 620	2 755		30
2 215		2 490	2 740	2 970	3 185	3 350	3 865	10
			2 235	2 425	2 600	2 725		50
		2 030	2 235	2 425	2 600	2 725		40
1 935		2 170	2 390	2 595	2 780	2 915		30
2 350		2 640	2 905	3 150	3 380	3 545	4 090	10
			2 525	2 740	2 935	3 150		50
		2 290	2 525	2 740	2 935	3 150		40
2 185		2 455	2 700	2 930	3 140	3 370		30
2 655		2 985	3 285	3 560	3 820	4 095	4 725	10
			2 660	2 885	3 095	3 350		50
		2 420	2 660	2 885	3 095	3 350		40
2 305		2 590	2 850	3 090	3 315	3 585		30
2 800		3 145	3 460	3 755	4 025	4 355	5 025	10

kW	22	44	66	88	110	132	150	162	184	>220
hp	30	60	90	120	150	180	200	220	250	>300



AC 85



AC 85

Modern design delivers outstanding performance, traction, durability, and long tyre life



Outstanding long tyre life thanks to the use of a wear-resistant tread compound.



Durable radial tyre with balanced characteristics for a wide range of applications both in the field and on the road.



Large contact patch enhances **traction**.



AC 85

Technical data and load capacities

Tyre size	Service description LI/SS	Rims * (permitted)	Section width (mm)	Overall diameter (mm)	Loaded static radius (mm)	Rolling circumference (mm)	Speed radius index	
280/85 R 20 (11.2 R 20)	112 A8 (112 B)	W 10 W 9	299 289	981	444	2 934	475	
280/85 R 24 (11.2 R 24)	115 A8 (115 B)	W 10 W 9	296 286	1 090	497	3 267	525	
320/85 R 24 (12.4 R 24)	122 A8 (122 B)	W 11 W 10 W 9	343 333 323	1 158	530	3 484	550	
340/85 R 24 (13.6 R 24)	125 A8 (125 B)	W 12 W 11	372 362	1 189	536	3 552	575	
380/85 R 24 (14.9 R 24)	131 A8 (131 B)	W 12 W 13 W 11	402 412 392	1 258	563	3 745	600	
420/85 R 24 (16.9 R 24)	137 A8 (137 B)	W 15 W 14 W 13	475 465 455	1 320	591	3 930	625	
280/85 R 28 (11.2 R 28)	118 A8 (118 B)	W 10 W 9	298 288	1 190	551	3 582	575	
320/85 R 28 (12.4 R 28)	124 A8 (124 B)	W 11 W 10 W 9	329 319 309	1 259	578	3 793	600	
340/85 R 28 (13.6 R 28)	127 A8 (127 B)	W 12 W 11	367 357	1 299	587	3 885	625	
380/85 R 28 (14.9 R 28)	133 A8 (133 B)	W 12 W 13 W 11	401 411 391	1 362	608	4 050	650	



	Tyre load capacity (kg) at tyre pressure (bar)									Speed (km/h)
	0.6	0.8	1.0	1.2	1.4	1.6	2.0	2.4	3.0	
			900	980	1 050	1 120				50
		820	900	980	1 050	1 120				40
	780	880	970	1 050	1 125	1 200				30
	950	1 070	1 175	1 275	1 365	1 455	1 680			10
			980	1 070	1 140	1 215				50
		890	980	1 070	1 140	1 215				40
	850	960	1 050	1 140	1 220	1 300				30
	1 030	1 160	1 280	1 390	1 490	1 580	1 825			10
			1 205	1 305	1 400	1 500				50
		1 095	1 205	1 305	1 400	1 500				40
	1 045	1 175	1 290	1 400	1 500	1 605				30
	1 270	1 425	1 570	1 700	1 825	1 950	2 250			10
			1 325	1 435	1 540	1 650				50
		1 205	1 325	1 435	1 540	1 650				40
	1 145	1 290	1 420	1 535	1 650	1 765				30
	1 395	1 565	1 720	1 870	2 005	2 145	2 475			10
			1 575	1 710	1 830	1 950				50
		1 430	1 575	1 710	1 830	1 950				40
	1 365	1 530	1 685	1 830	1 960	2 090				30
	1 660	1 860	2 050	2 220	2 380	2 535	2 925			10
			1 845	2 000	2 145	2 300				50
		1 675	1 845	2 000	2 145	2 300				40
	1 595	1 795	1 970	2 140	2 295	2 460				30
	1 940	2 175	2 395	2 600	2 790	2 990	3 450			10
			1 060	1 150	1 235	1 320				50
		965	1 060	1 150	1 235	1 320				40
	920	1 030	1 135	1 230	1 320	1 410				30
	1 120	1 255	1 380	1 495	1 605	1 715	1 980			10
			1 295	1 405	1 510	1 600				50
		1 180	1 295	1 405	1 510	1 600				40
	1 125	1 260	1 385	1 505	1 615	1 710				30
	1 365	1 530	1 685	1 830	1 960	2 080	2 400			10
			1 425	1 540	1 655	1 750				50
		1 295	1 425	1 540	1 655	1 750				40
	1 230	1 380	1 520	1 650	1 770	1 875				30
	1 500	1 680	1 850	2 005	2 150	2 275	2 625			10
			1 690	1 830	1 965	2 060				50
		1 535	1 690	1 830	1 965	2 060				40
	1 460	1 640	1 800	1 960	2 100	2 205				30
	1 775	1 995	2 195	2 380	2 550	2 680	3 090			10

AC 85 (continued)

Technical data and load capacities

Tyre size	Service description LI/SS	Rims * (permitted)	Section width (mm)	Overall diameter (mm)	Loaded static radius (mm)	Rolling circumference (mm)	Speed radius index	
420/85 R 28 (16.9 R 28)	139 A8 (139 B)	W 15 W 14 W 13	459 449 439	1 431	641	4 262	675	
380/85 R 30 (14.9 R 30)	135 A8 (135 B)	W 12 W 13 W 11	398 408 388	1 427	641	4 255	675	
420/85 R 30 (16.9 R 30)	140 A8 (140 B)	W 15 W 14 W 13	472 462 452	1 478	666	4 414	700	
420/90 R 30	147 A8 (147 B)	W 13 W 14	434 444	1 529	681	4 520	725	
460/85 R 30 (18.4 R 30)	145 A8 (145 B)	W 16 W 15 W 14	516 506 496	1 546	697	4 618	725	
380/85 R 34 (14.9 R 34)	146 A8 (146 B)	W 12 W 13 W 11	401 411 391	1 538	699	4 577	725	
420/85 R 34 (16.9 R 34)	142 A8 (142 B)	W 15 W 14 W 13	471 461 451	1 598	724	4 761	750	
420/85 R 34 (16.9 R 34)	147 A8 (147 B)	W 15 W 14 W 13	469 459 449	1 593	722	4 755	750	
460/85 R 34 (18.4 R 34)	147 A8 (147 B)	W 16 W 15 W 14	518 508 498	1 676	756	4 982	775	
340/85 R 38 (13.6 R 38)	133 A8 (133 B)	W 12 W 11	365 355	1 562	719	4 685	750	



AC 85

	Tyre load capacity (kg) at tyre pressure (bar)									Speed (km/h)
	0.6	0.8	1.0	1.2	1.4	1.6	2.0	2.4	3.0	
			1 970	2 135	2 290	2 430				50
		1 790	1 970	2 135	2 290	2 430				40
	1 705	1 915	2 110	2 290	2 450	2 600				30
	2 070	2 325	2 560	2 780	2 980	3 160	3 645			10
			1 740	1 890	2 025	2 180				50
		1 585	1 740	1 890	2 025	2 180				40
	1 510	1 695	1 865	2 020	2 170	2 335				30
	1 835	2 060	2 265	2 460	2 635	2 835	3 270			10
			2 030	2 205	2 365	2 500				50
		1 845	2 030	2 205	2 365	2 500				40
	1 760	1 975	2 175	2 360	2 530	2 675				30
	2 140	2 400	2 640	2 865	3 075	3 250	3 750			10
			1 920	2 160	2 405	2 650	2 895	3 075		50
		1 680	1 920	2 160	2 405	2 650	2 895	3 075		40
	1 540	1 800	2 055	2 315	2 575	2 835	3 095	3 290		30
	1 875	2 185	2 500	2 810	3 125	3 445	3 760	4 000	4 615	10
			2 340	2 540	2 720	2 900				50
		2 130	2 340	2 540	2 720	2 900				40
	2 030	2 280	2 510	2 720	2 910	3 100				30
	2 460	2 760	3 040	3 300	3 540	3 770	4 350			10
			1 680	2 005	2 150	2 290	2 535	3 000		50
		1 680	1 850	2 005	2 150	2 290	2 535	3 000		40
	1 600	1 800	1 980	2 145	2 300	2 450	2 710	3 210		30
	1 945	2 185	2 405	2 610	2 795	2 970	3 295	3 900	4 500	10
			2 155	2 335	2 505	2 650				50
		1 955	2 155	2 335	2 505	2 650				40
	1 865	2 095	2 305	2 500	2 680	2 835				30
	2 265	2 545	2 800	3 035	3 255	3 445	3 975			10
			2 155	2 335	2 505	2 650	2 905	3 075		50
		1 955	2 155	2 335	2 505	2 650	2 905	3 075		40
	1 865	2 095	2 305	2 500	2 680	2 835	3 110	3 290		30
	2 265	2 545	2 800	3 035	3 255	3 445	3 775	4 000	4 615	10
			2 475	2 685	2 880	3 075				50
		2 250	2 475	2 685	2 880	3 075				40
	2 145	2 405	2 650	2 875	3 080	3 290				30
	2 605	2 925	3 220	3 490	3 745	4 000	4 615			10
			1 655	1 795	1 925	2 060				50
		1 500	1 655	1 795	1 925	2 060				40
	1 430	1 605	1 770	1 920	2 060	2 205				30
	1 740	1 955	2 150	2 335	2 500	2 680	3 090			10

AC 85 (continued)

Technical data and load capacities

Tyre size	Service description LI/SS	Rims * (permitted)	Section width (mm)	Overall diameter (mm)	Loaded static radius (mm)	Rolling circumference (mm)	Speed radius index	
380/80 R 38 (14.9 R 38)	142 A8 (142 B)	W 12 W 11 W 13	380 370 390	1 590	730	4 790	750	
380/95 R 38	147 D (150 A8)	W 12 W 11 W 13	380 370 390	1 680	770	5 050	800	
15.5 R 38¹⁾	134 A8 (134 B)	W 14	400	1 570	723	4 712	750	
420/85 R 38 (16.9 R 38)	144 A8 (144 B)	W 15 W 14 W 13	469 459 449	1 696	772	5 088	800	
460/85 R 38 (18.4 R 38)	149 A8 (149 B)	W 16 W 15 W 14	508 498 488	1 768	805	5 280	825	
520/85 R 38 (20.8 R 38)	155 A8 (155 B)	W 16 W 18	545 565	1 857	827	5 515	875	
480/80 R 42 (18.4 R 42)	151 A8 (151 B)	W 16 W 15 W 14	513 503 495	1 850	835	5 540	875	
520/85 R 42 (20.8 R 42)	162 A8 (162 B)	W 16 W 18	537 557	1 966	896	5 878	925	
480/80 R 46 (18.4 R 46)	158 A8 (158 B)	W 16 W 15 W 14	507 497 487	1 960	896	5 886	925	
520/85 R 46 (20.8 R 46)	158 A8 (158 B)	W 16 W 18	545 565	2 043	930	6 131	975	

¹⁾ Tread pattern AC 51

AC 85



	Tyre load capacity (kg) at tyre pressure (bar)									Speed (km/h)
	0.6	0.8	1.0	1.2	1.4	1.6	2.0	2.4	3.0	
1 455 1 770	1 545 1 655 2 010	1 720 1 720 1 840 2 235	1 880 1 880 2 010 2 440	2 090 2 090 2 235 2 715	2 300 2 300 2 460 2 990	2 505 2 505 2 680 3 255	2 650 2 650 2 835 3 445		3 900	50 40 30 10
	1 875 1 955 2 050 2 495	1 985 2 085 2 170 2 495	2 170 2 280 2 375 2 495 3 035	2 410 2 530 2 640 2 770 3 375	2 650 2 785 2 900 3 050 3 710	2 900 3 045 3 175 3 335 4 060	3 075 3 230 3 350 3 535 4 305		4 615	65 50 40 30 10
1 240 1 500	1 350 1 440 1 750	1 540 1 540 1 650 2 010	1 740 1 740 1 860 2 260	1 930 1 930 2 060 2 510	2 120 2 120 2 270 2 760		3 180			50 40 30 10
1 965 2 390	2 065 2 210 2 685	2 270 2 270 2 430 2 955	2 465 2 465 2 635 3 205	2 640 2 640 2 830 3 435	2 800 2 800 3 000 3 640		4 200			50 40 30 10
2 255 2 745	2 370 2 535 3 080	2 605 2 605 2 790 3 390	2 830 2 830 3 030 3 680	3 030 3 030 3 245 3 945	3 250 3 250 3 480 4 225		4 875			50 40 30 10
2 725 3 310	2 860 3 060 3 720	3 150 3 150 3 370 4 090	3 415 3 415 3 655 4 440	3 660 3 660 3 920 4 760	3 875 3 875 4 145 5 040		5 815			50 40 30 10
2 170 2 840	2 305 2 465 3 230	2 565 2 565 2 745 3 590	2 805 2 805 3 000 3 925	3 125 3 125 3 345 4 375	3 450 3 450 3 690 4 830		5 175			50 40 30 10
2 860 3 470	2 995 3 205 3 895	3 300 3 300 3 530 4 285	3 575 3 575 3 825 4 650	3 840 3 840 4 100 4 990	4 075 4 075 4 360 5 300	4 520 4 520 4 835 5 875	4 750 4 750 5 085 6 175		7 125	50 40 30 10
2 270 2 760	2 410 2 580 3 135	2 685 2 685 2 870 3 485	2 935 2 935 3 140 3 815	3 245 3 245 3 470 4 215	3 550 3 550 3 800 4 615	3 960 3 960 4 240 5 545	4 250 4 250 4 550 5 950		6 300	50 40 30 10
2 785 3 625	3 130 3 350 4 070	3 445 3 445 3 685 4 480	3 735 3 735 4 000 4 855	4 005 4 005 4 290 5 210	4 250 4 250 4 550 5 525		6 375			50 40 30 10

AC 85 (continued)

Technical data and load capacities

Tyre size	Service description LI/SS	Rims * (permitted)	Section width (mm)	Overall diameter (mm)	Loaded static radius (mm)	Rolling circumference (mm)	Speed radius index	
380/90 R 50 (14.9 R 50)	151 A8 (151 B)	W 12 W 13 W 11	380 390 370	1 949	888	5 850	925	
480/80 R 50	159 A8 (159 B)	W 16 W 15 W 14	495 485 475	2 065	945	6 210	975	
480/95 R 50	164 D (167 A8)	W 16 W 15 W 14	498 488 478	2 135	968	6 450	1075	

* Further admissible rims on request

Load values for 0.6 bar are for calculating dual and triple load values only.

30 km/h (up to 40 km/h) load values also apply for low-speed high-torque field work.

For plowing with single driven tyres in the furrow, a minimum inflation pressure of 0.8 bar is required.

For intensive road transport at 65/50/40/30 km/h the pressure must be increased by 0.4 bar. Maximum inflation pressure should never be exceeded.

All load values are valid for ground slopes up to and including 20% (11°). When operating on slopes greater than 20%, please, contact the producer.

Tubeless tyres – may be used with a tube.



AC 85

	Tyre load capacity (kg) at tyre pressure (bar)									Speed (km/h)
	0.6	0.8	1.0	1.2	1.4	1.6	2.0	2.4	3.0	
			2 180	2 385	2 640	2 900	3 215	3 450		50
		1 960	2 180	2 385	2 640	2 900	3 215	3 450		40
	1 845	2 095	2 330	2 550	2 825	3 105	3 440	3 690		30
	2 415	2 745	3 050	3 335	3 700	4 060	4 505	4 830	5 175	10
			2 800	3 060	3 405	3 750	4 105	4 375		50
		2 515	2 800	3 060	3 405	3 750	4 105	4 375		40
	2 370	2 695	2 995	3 275	3 645	3 830	4 395	4 680		30
	3 100	3 525	3 920	4 285	4 765	5 010	5 750	6 125	6 565	10
			3 220	3 530	3 950	4 375	4 715	5 000		65
		3 050	3 390	3 710	4 150	4 590	4 955	5 250		50
		3 180	3 535	3 865	4 325	4 750	5 165	5 450		40
		3 340	3 715	4 060	4 545	5 030	5 425	5 750		30
		4 065	4 520	4 945	4 860	6 120	6 605	7 000	7 500	10



AC 85

LOAD CAPACITY	██████████
TRACTION	██████████
CROP PROTECTION	██████████
HANDLING ON ROAD	██████████
COST EFFICIENCY	██████████



AC 90

LOAD CAPACITY	██████████
TRACTION	██████████
CROP PROTECTION	██████████
HANDLING ON ROAD	██████████
COST EFFICIENCY	██████████

AC 85 / AC 90 Row Crop

Narrow tyres developed specially for row cultivation



Reduced tyre width eases driving between plants without causing damage, contributing to higher yields. Rounded shoulders, lugs and tyre height also protect crops.



Cost-efficient thanks to durable construction that offers high load capacity and transport speeds up to 65 km/h.



Deep lugs provide **excellent traction**, better directional stability and a high level of control.



Good self-cleaning properties help keep the tread pattern free of mud, resulting in less slip, even in difficult conditions.

AC 85 / AC 90 vs. standard size tyres

Narrow Row Crop tyres were specially developed for driving between rows without damaging the seeds, roots and plants. They are suitable for line weeding, crop cultivation, fertilising, spraying and other agricultural activities.

Reduced tyre width



Tractor fitted with Mitas narrow tyres

Tractor fitted with wide tread-width tyres

Rounded lugs

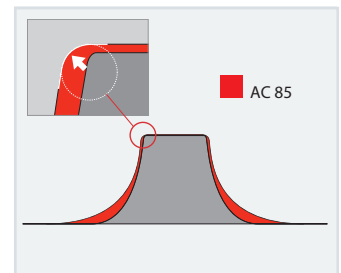

Row Crop

Technical data and load capacities

Tyre size	Tread pattern	Service description LI/SS	Rims * (permitted)	Section width (mm)	Overall diameter (mm)	Loaded static radius (mm)	Rolling circumference (mm)	Speed radius index	
270/80 R 32 (repl. 9.5 R 32)	AC 90	131 A8 (128 B)	W 9 W 10 W 8	270 280 260	1 225	563	3 690	600	
270/95 R 32	AC 85	136 A8 (136 B)	W 9 W 10 W 8	290 300 280	1 349	619	4 054	625	
320/85 R 32 (repl. 12.4 R 32)	AC 85	142 A8 (142 B)	W 10 W 11 W 9	309 319 299	1 365	625	4 035	650	
320/85 R 32 (repl. 12.4 R 32)	AC 85	145 A8 (145 B)	W 10 W 11 W 9	317 327 307	1 368	625	4 035	650	
320/90 R 32	AC 85	134 A8 (134 B)	W 10 W 11 W 9	331 341 321	1 391	638	4 190	675	
320/85 R 34 (repl. 12.4 R 34)	AC 85	133 A8 (133 B)	W 10 W 11 W 9	326 336 316	1 430	650	4 285	675	
270/80 R 36 (repl. 9.5 R 36)	AC 90	134 A8 (131 B)	W 9 W 10 W 8	270 280 260	1 345	623	4 015	650	

AC 85



AC 90



	Tyre load capacity (kg) at tyre pressure (bar)									Speed (km/h)
	1.2	1.6	2.0	2.4	2.8	3.2	3.6	4.0	4.4	
		1 150	1 265	1 345	1 470	1 585	1 685	1 800		50
	1 035	1 265	1 390	1 480	1 620	1 740	1 855	1 950		40
	1 110	1 355	1 485	1 585	1 730	1 865	1 985	2 085		30
	1 275	1 555	1 710	1 820	1 990	2 145	2 280	2 400		20
	1 450	1 770	1 945	2 070	2 265	2 440	2 595	2 730	2 845	10
	1 555	1 900	2 085	2 220	2 425	2 615	2 780	2 925	3 050	10 Cyclic
		1 450	1 600	1 700	1 865	2 010	2 145	2 240		50
	1 190	1 450	1 600	1 700	1 865	2 010	2 145	2 240		40
	1 275	1 550	1 710	1 820	1 995	2 155	2 295	2 395		30
	1 465	1 785	1 965	2 090	2 295	2 475	2 640	2 755		20
	1 670	2 030	2 235	2 380	2 610	2 815	3 005	3 135	3 310	10
	1 785	2 175	2 395	2 550	2 795	3 020	3 215	3 360	3 545	10 Cyclic
		1 710	1 880	2 000	2 190	2 360	2 515	2 650		50
	1 400	1 710	1 880	2 000	2 190	2 360	2 515	2 650		40
	1 500	1 830	2 010	2 140	2 345	2 530	2 690	2 835		30
	1 725	2 105	2 310	2 460	2 695	2 905	3 095	3 260		20
	1 960	2 395	2 630	2 800	3 065	3 305	3 520	3 710	3 875	10
	2 100	2 570	2 820	3 000	3 285	3 545	3 775	3 975	4 150	10 Cyclic
		1 710	1 880	2 000	2 190	2 360	2 515	2 650	2 900	50
	1 400	1 710	1 880	2 000	2 190	2 360	2 515	2 650	2 900	40
	1 500	1 830	2 010	2 140	2 345	2 530	2 690	2 835	3 105	30
	1 725	2 105	2 310	2 460	2 695	2 905	3 095	3 260	3 565	20
	1 960	2 395	2 630	2 800	3 065	3 305	3 520	3 710	4 060	10
	2 100	2 570	2 820	3 000	3 285	3 545	3 775	3 975	4 350	10 Cyclic
		1 795	1 990	2 120						50
	1 575	1 795	1 990	2 120						40
	1 690	1 920	2 130	2 270						30
	1 935	2 205	2 445	2 605	(3.0 bar)					20
	2 050	2 335	2 590	2 760	3 180					10
	2 195	2 500	2 770	2 955	3 400					10 Cyclic
		1 750	1 935	2 060						50
	1 445	1 750	1 935	2 060						40
	1 545	1 875	2 070	2 205						30
	1 775	2 155	2 380	2 535						20
	2 020	2 450	2 710	2 885	2 995					10
	2 165	2 625	2 905	3 090	3 205					10 Cyclic
		1 225	1 345	1 435	1 575	1 705	1 825	1 950		50
	1 105	1 350	1 480	1 575	1 730	1 875	2 005	2 120		40
	1 180	1 440	1 580	1 685	1 850	2 005	2 145	2 270		30
	1 355	1 660	1 820	1 940	2 130	2 305	2 465	2 610		20
	1 545	1 885	2 070	2 205	2 425	2 625	2 805	2 970	3 115	10
	1 655	2 020	2 220	2 365	2 595	2 810	3 005	3 180	3 335	10 Cyclic

Row Crop (continued)

Technical data and load capacities

Tyre size	Tread pattern	Service description L/SS	Rims * (permitted)	Section width (mm)	Overall diameter (mm)	Loaded static radius (mm)	Rolling circumference (mm)	Speed radius index	
13.6 R 36	AC 90	127 A8 (124 B)	W 12 W 11	360 350	1 499	692	4 492	725	
320/85 R 38 (repl. 12.4 R 38)	AC 85	143 A8 (143 B)	W 10 W 11 W 9	322 332 312	1 518	701	4 580	725	
340/85 R 38 (repl. 13.6 R 38)	AC 85	148 A8 (148 B)	W 11 W 12	355 365	1 562	719	4 685	750	
650/65 R 38°	AC 65	173 D (176 A8)	DW 20 B DW 21 B DW 18 L	640 650 620	1 840	828	5 461	875	
300/85 R 42 (repl. 11.2 R 42)	AC 90	144 A8 (141 B)	W 9 W 10 W 11	288 298 308	1 574	740	4 715	750	
300/95 R 42 (repl. 12.4 R 42)	AC 90	147 A8 (144 B)	W 9 W 10 W 11	296 306 316	1 617	753	4 904	775	
320/90 R 42	AC 85	151 A8 (151 B)	W 10 W 11 W 9	319 329 309	1 643	765	4 970	800	



	Tyre load capacity (kg) at tyre pressure (bar)									Speed (km/h)
	1.2	1.6	2.0	2.4	2.8	3.2	3.6	4.0	4.4	
1 300	1 600									50
1 430	1 750									40
1 530	1 870									30
1 760	2 150									20
1 860	2 280	2 630								10
1 990	2 440	2 830								10 Cyclic
1 530	1 850	2 050	2 180	2 395	2 585	2 725				50
1 635	1 980	2 195	2 180	2 395	2 585	2 725				40
1 880	2 275	2 520	2 335	2 560	2 765	2 915				30
2 140	2 590	2 870	2 680	2 945	3 175	3 350				20
2 445	2 960	3 280	3 050	3 350	3 715	3 815	4 065			10
			3 490	3 590	4 135	4 360	4 645			10 Cyclic
1 795	2 060	2 230	2 360	2 620	2 825	3 010	3 150			50
1 920	2 205	2 385	2 360	2 620	2 825	3 010	3 150			40
2 205	2 535	2 745	2 525	2 800	3 025	3 225	3 370			30
2 515	2 885	3 125	2 905	3 220	3 475	3 705	3 875			20
2 695	3 090	3 345	3 305	3 665	3 955	4 215	4 410	4 650		10
			3 540	3 930	4 240	4 520	4 725	4 980		10 Cyclic
3 450	4 125	4 530	4 875	5 300	5 800	6 150	6 500			65
3 625	4 330	4 760	5 120	5 565	6 090	6 460	6 825			50
3 780	4 500	4 960	5 300	5 800	6 300	6 700	7 100			40
3 970	4 745	5 210	5 605	6 095	6 670	7 075	7 475			30
4 245	5 075	5 570	5 995	6 520	7 135	7 565	7 995			20
4 830	5 775	6 345	6 825	7 420	8 120	8 610	9 100			10
5 520	6 600	7 250	7 800	8 480	9 280	9 840	10 400			10 Cyclic
1 465	1 630	1 790	1 905	2 090	2 260	2 410	2 575			50
1 570	1 790	1 965	2 095	2 300	2 485	2 650	2 800			40
1 805	1 920	2 105	2 240	2 460	2 655	2 835	2 995			30
2 055	2 205	2 420	2 575	2 825	3 055	3 260	3 445			20
2 200	2 510	2 755	2 935	3 215	3 470	3 695	3 920	4 105		10
	2 690	2 950	3 145	3 445	3 725	3 975	4 200	4 395		10 Cyclic
1 605	1 785	1 955	2 085	2 290	2 475	2 645	2 800			50
1 715	1 960	2 150	2 290	2 515	2 720	2 905	3 075			40
1 970	2 095	2 300	2 450	2 690	2 910	3 110	3 290			30
2 245	2 410	2 645	2 815	3 095	3 345	3 575	3 780			20
2 405	2 745	3 010	3 205	3 520	3 810	4 070	4 305	4 515		10
	2 940	3 225	3 425	3 770	4 080	4 360	4 615	4 835		10 Cyclic
1 700	2 060	2 240	2 430	2 650	2 900	3 075	3 250	3 450		50
1 700	2 060	2 240	2 430	2 650	2 900	3 075	3 250	3 450		40
1 820	2 205	2 395	2 600	2 835	3 100	3 290	3 480	3 690		30
2 090	2 535	2 755	2 990	3 260	3 570	3 780	4 000	4 245		20
2 380	2 885	3 135	3 400	3 710	4 060	4 305	4 550	4 830		10
2 550	3 090	3 360	3 645	3 975	4 350	4 615	4 875	5 175		10 Cyclic

Row Crop (continued)

Technical data and load capacities

Tyre size	Tread pattern	Service description LI/SS	Rims * (permitted)	Section width (mm)	Overall diameter (mm)	Loaded static radius (mm)	Rolling circumference (mm)	Speed radius index	
IF 320/90 R 42	AC 85	155 B	W 11 W 10	323 313	1 643	750	4 930	800	
320/95 R 46	AC 85	152 A8 (152B)	W 10 W 11 W 9	330 340 320	1 770	806	5 298	825	
380/90 R 46 (repl. 14.9 R 46)	AC 85	149 A8 (149 B)	W 12 W 13 W 11	392 402 382	1 844	846	5 542	875	
380/90 R 46 (repl. 14.9 R 46)	AC 85	159 A8 (159 B)	W 12 W 13 W 11	392 402 382	1 844	846	5 542	875	
270/95 R 48 (repl. 11.2 R 48)	AC 90	144 A8 (141 B)	W 9 W 10 W 8	277 287 267	1 737	810	5 220	825	
340/90 R 48 (repl. 13.6 R 48)	AC 85	154 A8 (154 B)	W 11 W 12	348 358	1 825	843	5 481	875	
320/90 R 50	AC 85	150 A8 (150 B)	W 10 W 11 W 9	315 325 305	1 870	873	5 680	875	
380/90 R 50 (repl. 14.9 R 50)	AC 85	160 A8 (160 B)	W 12 W 13 W 11	380 390 370	1 949	888	5 850	975	

AC 85



AC 90



	Tyre load capacity (kg) at tyre pressure (bar)									Speed (km/h)
	1.2	1.6	2.0	2.4	2.8	3.2	3.6	4.0	4.4	
2 040 1 795	2 500 2 200	2 725 2 400	2 900 2 550	3 150 2 770	3 450 3 035	3 650 3 215	3 875 3 410			50 50 Cyclic
1 850 1 980 2 275 2 405 2 775	2 240 2 240 2 395 2 755 2 910 3 360	2 485 2 485 2 655 3 055 3 475 3 720	2 650 2 650 2 825 3 260 3 700 3 965	2 895 2 895 3 100 3 560 4 055 4 340	3 125 3 125 3 345 3 845 4 375 4 685	3 330 3 330 3 565 4 095 4 660 4 995	3 550 3 550 3 800 4 365 4 970 5 325		5 140 5 505	50 40 30 20 10 10 Cyclic
2 280 2 440 2 805 3 195 3 425	2 790 2 790 2 985 3 430 3 905 4 185	3 060 3 060 3 275 3 765 4 285 4 590	3 250 3 250 3 480 4 000 4 550 4 875		(3.0 bar) 4 875 5 200					50 40 30 20 10 10 Cyclic
2 280 2 440 2 805 3 195 3 425	2 790 2 790 2 985 3 430 3 905 4 185	3 060 3 060 3 275 3 765 4 285 4 590	3 250 3 250 3 480 4 000 4 550 4 875	3 580 3 580 3 830 4 405 5 010 5 370	3 870 3 870 4 145 4 760 5 420 5 810	4 135 4 135 4 425 5 090 5 790 6 205	4 375 4 375 4 680 5 380 6 125 6 565		6 420 6 880	50 40 30 20 10 10 Cyclic
1 475 1 580 1 815 2 070 2 215	1 645 1 805 1 930 2 220 2 525 2 710	1 805 1 980 2 120 2 435 2 775 2 970	1 920 2 110 2 260 2 595 2 955 3 165	2 105 2 310 2 475 2 840 3 235 3 465	2 270 2 495 2 665 3 065 3 490 3 740	2 415 2 655 2 840 3 245 3 720 3 985	2 575 2 800 2 995 3 445 3 920 4 200		4 095 4 390	50 40 30 20 10 10 Cyclic
1 980 2 120 2 435 2 575 2 970	2 430 2 430 2 600 2 990 3 160 3 645	2 645 2 645 2 830 3 250 3 435 3 965	2 800 2 800 2 995 3 445 3 640 4 200	3 100 3 100 3 315 3 810 4 030 4 650	3 345 3 345 3 580 4 115 4 350 5 015	3 565 3 565 3 815 4 385 4 635 5 345	3 750 3 750 4 015 4 615 4 875 5 625		5 110 5 895	50 40 30 20 10 10 Cyclic
1 855 1 980 2 280 2 595 2 780	2 265 2 265 2 425 2 785 3 170 3 395	2 485 2 485 2 660 3 055 3 480 3 730	2 650 2 650 2 830 3 255 3 705 3 970	2 900 2 900 3 105 3 565 4 060 4 350	3 130 3 130 3 350 3 850 4 380 4 695	3 350 3 350 3 585 4 120 4 690 5 025		4 925 5 275		50 40 30 20 10 10 Cyclic
2 385 2 550 2 930 3 335 3 575	2 900 2 900 3 105 3 565 4 060 4 350	3 215 3 215 3 440 3 955 4 505 4 825	3 450 3 450 3 690 4 245 4 830 5 175	3 730 3 730 3 990 4 590 5 220 5 595	4 025 4 025 4 305 4 950 5 635 6 040	4 290 4 290 4 590 5 275 6 005 6 435	4 500 4 500 4 815 5 535 6 300 6 750		6 620 7 095	50 40 30 20 10 10 Cyclic

Row Crop (continued)

Technical data and load capacities

Tyre size	Tread pattern	Service description LI/SS	Rims * (permitted)	Section width (mm)	Overall diameter (mm)	Loaded static radius (mm)	Rolling circumference (mm)	Speed radius index	
320/90 R 54	AC 85	151 A8 (151 B)	W 10 W 11 W 9	315 325 305	1 948	917	5 940	975	
380/90 R 54	AC 85	152 A8 (152 B)	W 12 W 13 W 11	380 390 370	2 056	945	6 200	1 025	
380/105 R 54	AC 85	162 D (164 B)	W 12 W 13 W 11	380 390 370	2 170	1 012	6 580	1 025	

* Further admissible rims on request

° In preparation, please contact Mitas for availability

30 km/h (up to 40 km/h) load values also apply for low-speed high-torque field work.

For plowing with single driven tyres in the furrow, a minimum inflation pressure of 0.8 bar is required.

For intensive road transport at 50/40/30 km/h the pressure must be increased by 0.4 bar. Maximum inflation pressure should never be exceeded.

All load values are valid for ground slopes up to and including 20% (11°). When operating on slopes greater than 20%, please, contact the producer.

Load-pressure data for cyclic applications apply to low-torque transport operations at max. speeds of 10 km/h and for a max. distance of 800 meters before discharging the load and returning empty.

Tubeless tyres – may be used with a tube.

AC 85



AC 90



	Tyre load capacity (kg) at tyre pressure (bar)									Speed (km/h)
	1.2	1.6	2.0	2.4	2.8	3.2	3.6	4.0	4.4	
							3 450			50
1 930	2 360	2 590	2 760	3 025	3 265	3 265	3 450			40
2 070	2 525	2 775	2 955	3 235	3 490	3 690				30
2 375	2 905	3 190	3 395	3 720	4 015	4 225				20
2 705	3 305	3 630	3 865	4 235	4 570	4 830		5 135		10
2 900	3 545	3 890	4 140	4 535	4 895	5 175		5 505		10 Cyclic
										50
2 485	3 000	3 330	3 550							40
2 485	3 000	3 330	3 550							30
2 655	3 210	3 565	3 800							20
3 055	3 690	4 095	4 365							10
3 225	3 900	4 330	4 615	4 800						10
3 725	4 500	4 995	5 325	5 535						10 Cyclic
										65
2 800	3 450	3 750	4 000	4 375	4 750					50
2 940	3 620	3 940	4 200	4 595	5 000					40
3 070	3 780	4 105	4 380	4 790	5 200					30
3 220	3 970	4 315	4 600	5 030	5 460					10
3 920	4 830	5 250	5 600	6 125	6 650					10
4 520	5 570	6 055	6 460	7 065	7 670					10 Cyclic



HC 3000



HC 3000

New Very High Flexion (VF) harvester tyre for Cyclic Field Operation (CFO)



Less inflation pressure provides **excellent traction** efficiency.





Higher load capacity for higher haulage efficiency.



Larger footprint for **better ground protection** and **reduced soil compaction**.

Mitas VF 710/70 R 42 CFO HC 3000

Lower Soil Compaction for sustainable farming.

Standard	710/70 R 42 179A8	VF 710/70 R 42 CFO	800/70 R 38 181A8
Inflation pressure (bar)	3.8	2.8	3.0
Footprint (%)	100	136	127
		 + 36%	 + 27%

Inflation Pressures and Footprints at 13 300 kg load/tyre at cyclic field conditions.



HC 3000

Technical data and load capacities

Tyre size	Service description LI/SS	Rims * (permitted)	Section width (mm)	Overall diameter (mm)	Loaded static radius (mm)	Rolling circumference (mm)	Speed radius index	
VF 1000/65 R 32 CFO^{o#}	200 A8	DW 36 DW 38	1 006 1 026	2 113	940	6 275	1 025	
VF 580/80 R 34 CFO	178 B	W 20 W 18 W 21	605 585 615	1 790	755	5 265	875	
VF 520/85 R 42 CFO	177 B	DW 18 L	557	1 966	875	5 850	925	
VF 580/85 R 42 CFO	183 B	DW 20 B DW 21 B	587 598	2 045	920	6 100	975	
VF 710/70 R 42 CFO	190 B	DW 23 B DW 25 B	706 726	2 070	920	6 140	975	

* Further admissible rims on request

^o In preparation, please contact Mitas for availability

[#] Tread pattern HC 3000 R

Load values for 0.4 bar and 0.6 bar at 50 km/h are for calculating dual and triple load values only.

For plowing with single driven tyres in the furrow, a minimum inflation pressure of 0.8 bar is required.

For intensive road transport at 50/40/30 km/h the pressure must be increased by 0.4 bar. Maximum inflation pressure should never be exceeded.

All load values are valid for ground slopes up to and including 20% (11°). When operating on slopes greater than 20%, please, contact the producer.

Load-pressure data for cyclic applications apply to low-torque transport operations at max. speeds of 15 km/h and for a max. distance of 800 meters before discharging the load and returning empty.

By cyclic application (CFO) mean harvester's motion with full grain tank till its discharging.

CFO: Cyclic Field Operation

Tubeless tyres – may be used with a tube.



HC 3000

	Tyre load capacity (kg) at tyre pressure (bar)									Speed (km/h)
	0.6	0.8	1.0	1.2	1.6	2.0	2.4	2.8	3.2	
								14 000		0-50 0-50 Dual 0-15 CFO 0-15 CFO Dual
	5 410 8 300 7 300	7 100 6 250 9 590 8 440	8 000 7 040 10 800 9 505	9 000 7 920 12 150 10 690	10 600 9 330 14 310 12 590	11 800 10 380 15 930 14 020	12 500 11 000 16 880 14 850	12 320 18 900 16 630		
	2 815 3 800	3 750 3 300 5 065 4 455	4 250 3 740 5 740 5 050	4 800 4 225 6 480 5 700	5 800 5 105 7 830 6 890	6 300 5 545 8 505 7 485	6 900 6 070 9 315 8 195	7 500 6 600 10 125 8 910		0-50 0-50 Dual 0-15 CFO 0-15 CFO Dual
			3 650 4 930	4 180 5 645	5 800 5 105 7 830 6 890	6 150 5 410 8 305 7 305	6 700 5 895 9 045 7 960	7 300 6 425 9 855 8 670		0-50 0-50 Dual 0-15 CFO 0-15 CFO Dual
			4 320 5 830	5 400 7 290	6 700 5 895 9 045 7 960	7 400 6 510 9 990 8 790	8 100 7 130 10 935 9 625	8 750 7 700 11 815 10 395		0-50 0-50 Dual 0-15 CFO 0-15 CFO Dual
			4 980 6 720	5 600 7 560	7 750 6 820 10 465 9 205	8 350 7 350 11 275 9 920	9 000 7 920 12 150 10 690	9 850 8 670 13 300 11 700	10 600 9 330 14 310 12 595	0-50 0-50 Dual 0-15 CFO 0-15 CFO Dual



SFT CHO



CHO

Cyclic Harvesting Operation tyre.
The most gentle ground handling
tyre extending comfortably the
harvesting time frame



Harvester tyre with **maximum cyclic axle load capacity**.



Extremely low inflation pressure and more maximum load capacity at the same time.



Larger footprint than standard harvester tyres guarantees gentler ground handling and extends the harvesting time frame.



Due to its **compact, narrow construction** the tyre fulfils all legal requirements (limited vehicle width).

Vehicle width decrease

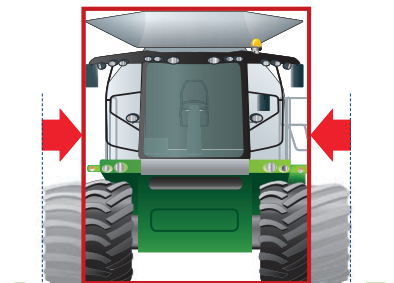

Mobility increase

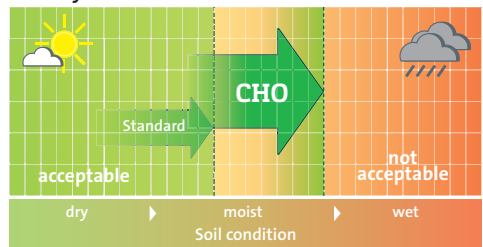

Harvesting time frame

Extension of time frame for harvesting by reducing inflation pressure.

Harvester CHO drive wheel

Technical data and load capacities

Tyre size	Tread pattern	Service description LI/SS	Rims * (permitted)	Section width (mm)	Overall diameter (mm)	Loaded static radius (mm)	Rolling circumference (mm)	Speed radius index
680/85 R 32 CHO	AC 70 G	178 A8 (175 B)	DW 20 B DW 21 B DW 23 B	663 673 693	1 960	858	5 865	925
800/70 R 32 CHO	SFT	175 A8 (172 B)	DW 25 B DW 27 B	748 768	1 932	845	5 630	925
900/60 R 32 CHO	SFT	176 A8 (173 B)	DW 27 B DW 30 B	835 865	1 927	851	5 700	925
900/70 R 32 CHO	SFT	182 A8 (179 B)	DW 27 B DW 30 B	881 911	2 061	904	6 075	975
900/70 R 32 CHO	SFT	188 A8 (185 B)	DW 27 B DW 30 B	885 915	2 058	904	6 075	975
1050/50 R 32 CHO°	SFT	184 A8 (181 B)	36.00 VA 36.00 / 1.7 DW 36 B	1 015	1 890	855	5 640	875
1250/50 R 32 CHO°	SFT	194 A8 (191 B)	44 40	1 230 1 190	2 040	890	6 000	975
680/80 R 38 CHO	SFT	179 D (182 A8)	DW 21 B DW 20 B DW 23 B	650 640 670	2 053	895	6 070	975



	Tyre load capacity (kg) at tyre pressure (bar)										Speed (km/h)
	0.6	0.8	1.0	1.2	1.4	1.6	2.0	2.4	2.8	3.2	
			3 865	4 230	4 635	5 000	5 515	6 000	6 435	6 900	50
		3 915	4 245	4 645	5 090	5 450	6 060	6 500	7 070	7 500	40
	3 775	4 190	4 540	4 970	5 445	5 830	6 485	6 955	7 565	8 025	30
	3 915	4 345	4 710	5 155	5 650	6 050	6 725	7 215	7 850	8 235	25
	4 340	4 815	5 220	5 715	6 260	6 705	7 450	7 995	8 695	9 225	20
	6 350	7 045	7 640	8 365	9 165	9 810	10 905	11 700	12 725	13 500	10 CHO
			4 180	4 575	5 010	5 450	5 965	6 300			50
		4 235	4 590	5 025	5 505	6 000	6 555	6 900			40
	4 085	4 530	4 915	5 380	5 895	6 420	7 015	7 385			30
	4 235	4 700	5 095	5 580	6 115	6 600	7 275	7 660			25
	4 695	5 210	5 650	6 180	6 775	7 380	8 060	8 485			20
		7 625	8 265	9 045	9 915	10 800	11 800	12 500			10 CHO
			4 250	4 650	5 020	5 300	5 950	6 500			50
		4 315	4 670	5 110	5 515	5 800	6 535	7 100			40
	4 165	4 615	5 000	5 465	5 900	6 205	6 995	7 595			30
	4 320	4 790	5 185	5 670	6 120	6 440	7 255	7 880			25
	4 790	5 305	5 745	6 285	6 785	7 135	8 040	8 735			20
		7 765	8 410	9 195	9 925	10 440	11 765	12 780			10 CHO
			4 660	5 055	5 530	6 060	6 700	7 215	7 750		50
		5 120	5 555	6 080	6 660	7 300	7 925	8 500			40
	4 940	5 480	5 945	6 505	7 125	7 810	8 480	9 095			30
	5 125	5 685	6 165	6 750	7 395	8 105	8 800	9 435			25
	5 675	6 300	6 830	7 475	8 195	8 980	9 750	10 455			20
		9 220	9 995	10 940	11 990	13 140	14 270	15 300			10 CHO
			5 055	5 530	6 060	6 700	7 215	7 750	8 415	9 250	50
		5 120	5 555	6 080	6 660	7 300	7 925	8 500	9 250	10 000	40
	4 940	5 480	5 945	6 505	7 125	7 810	8 480	9 095	9 895	10 700	30
	5 125	5 685	6 165	6 750	7 395	8 105	8 800	9 435	10 265	11 100	25
	5 675	6 300	6 830	7 475	8 195	8 980	9 750	10 455	11 375	12 300	20
		9 220	9 995	10 940	11 990	13 140	14 270	15 300	16 650	18 000	10 CHO
			4 625	5 000	5 300	5 800	6 300	6 900	7 500	8 250	50
		4 655	5 045	5 515	5 800	6 300	6 900	7 500	8 250	9 000	40
	4 495	4 985	5 400	5 900	6 210	6 740	7 385	8 025	8 830	9 630	30
	4 665	5 170	5 600	6 120	6 440	6 995	7 660	8 325	9 160	9 990	25
	5 170	5 730	6 205	6 785	7 135	7 750	8 485	9 225	10 150	11 070	20
	7 560	8 380	9 080	9 925	10 440	11 340	12 420	13 500	14 850	16 200	10 CHO
			5 655	6 265	7 010	7 750	8 500	9 100	10 040	10 900	50
		4 730	5 515	6 210	6 885	7 700	8 500	9 340	10 000	11 035	40
	5 060	5 905	6 645	7 365	8 240	9 095	9 995	10 700	11 805	12 625	30
	5 250	6 125	6 895	7 640	8 545	9 435	10 365	11 100	12 250	13 100	25
	5 815	6 785	7 640	8 470	9 470	10 455	11 490	12 300	13 575	14 515	20
	8 515	9 925	11 180	12 395	13 860	15 300	16 810	18 000	19 865	21 240	10 CHO
			4 070	4 580	5 090	5 600	6 125	6 500	7 175	7 750	65
		3 740	4 275	4 810	5 345	5 880	6 430	6 825	7 535	8 140	50
	3 345	3 900	4 460	5 015	5 575	6 150	6 705	7 100	7 855	8 500	40
	3 510	4 100	4 685	5 270	5 855	6 440	7 045	7 475	8 350	8 915	30
	3 620	4 220	4 825	5 430	6 030	6 635	7 260	7 705	8 505	9 185	25
		6 415	7 330	8 245	9 160	10 080	11 025	11 700	12 915	13 950	10 CHO

Harvester CHO drive wheel (continued)

Technical data and load capacities

Tyre size	Tread pattern	Service description LI/SS	Rims * (permitted)	Section width (mm)	Overall diameter (mm)	Loaded static radius (mm)	Rolling circumference (mm)	Speed radius index
800/70 R 38 CHO	SFT	178 D (181 A8)	DW 25 B DW 27 B	766 786	2 042	916	6 090	975
800/70 R 38 CHO	SFT	181 D (184 A8)	DW 25 B DW 27 B	766 786	2 042	916	6 090	975
900/60 R 38 CHO	SFT	178 D (181 A8)	DW 27 B DW 30 B	860 890	2 060	918	6 115	975
900/60 R 38 CHO	SFT	181 D (184 A8)	DW 27 B DW 30 B	860 890	2 060	918	6 115	975
680/80 R 42 CHO	SFT	180 D (183 A8)	DW 21 B DW 23 B DW 20 B	660 680 650	2 145	983	6 500	1 025
800/70 R 42 CHO	SFT	182 D (185 A8)	DW 25 B DW 27 B	774 794	2 160	945	6 320	1 025
900/60 R 42 CHO	SFT	183 D (186 A8)	DW 27 B DW 28 B DW 30 B	860 870 890	2 140	965	6 400	1 025

* Further admissible rims on request

* In preparation, please contact Mitas for availability

Load values for 0.6 bar are for calculating dual and triple load values only.

30 km/h (up to 40 km/h) load values also apply for low-speed high-torque field work.

For plowing with single driven tyres in the furrow, a minimum inflation pressure of 0.8 bar is required.

For intensive road transport at 65/50/40/30 km/h the pressure must be increased by 0.4 bar. Maximum inflation pressure should never be exceeded.



CHO

	Tyre load capacity (kg) at tyre pressure (bar)										Speed (km/h)	
	0.6	0.8	1.0	1.2	1.4	1.6	2.0	2.4	2.8	3.2		
			4 660	5 240	5 825	6 500	7 035	7 500				65
		4 280	4 895	5 500	6 115	6 825	7 380	7 875				50
	3 825	4 460	5 105	5 740	6 380	7 100	7 705	8 250				40
	4 020	4 685	5 360	6 025	6 700	7 475	8 090	8 625				30
	4 140	5 015	5 520	6 210	6 905	7 705	8 335	8 990				25
		7 340	8 385	9 435	10 485	11 700	12 665	13 500				10 CHO
			4 660	5 240	5 825	6 500	7 035	7 500	8 250			65
		4 280	4 895	5 500	6 115	6 825	7 380	7 875	8 665			50
	3 825	4 460	5 105	5 740	6 380	7 100	7 705	8 250	9 000			40
	4 020	4 685	5 360	6 025	6 700	7 475	8 090	8 625	9 490			30
	4 140	5 015	5 520	6 210	6 905	7 705	8 335	8 990	9 775			25
		7 340	8 385	9 435	10 485	11 700	12 665	13 500	14 850			10 CHO
			4 665	5 170	5 745	6 300	7 020	7 500				65
		4 350	4 900	5 430	6 030	6 615	7 370	7 875				50
	3 895	4 540	5 110	5 660	6 290	6 900	7 685	8 250				40
	4 090	4 765	5 365	5 945	6 605	7 245	8 075	8 625				30
	4 215	4 910	5 530	6 125	6 810	7 465	8 320	8 890				25
		7 460	8 400	9 310	10 345	11 340	12 635	13 500				10 CHO
			4 665	5 170	5 745	6 300	7 020	7 500	8 250			65
		4 350	4 900	5 430	6 030	6 615	7 370	7 875	8 665			50
	3 895	4 540	5 110	5 660	6 290	6 900	7 685	7 215	9 000			40
	4 090	4 765	5 365	5 945	6 605	7 245	8 075	8 625	9 490			30
	4 215	4 910	5 530	6 125	6 810	7 465	8 320	8 890	9 775			25
		7 460	8 400	9 310	10 345	11 340	12 635	13 500	14 850			10 CHO
			4 255	4 785	5 315	5 800	6 415	6 900	7 490	8 000		65
		3 905	4 470	5 025	5 580	6 090	6 735	7 245	7 865	8 400		50
	3 495	4 075	4 660	5 240	5 820	6 350	7 025	7 555	8 200	8 750		40
	3 670	4 280	4 895	5 505	6 110	6 670	7 375	7 935	8 615	9 200		30
	3 780	4 410	5 040	5 670	6 300	6 875	7 600	8 175	8 875	9 480		25
		6 700	7 655	8 610	9 570	10 440	11 550	12 420	13 480	14 400		10 CHO
			4 865	5 470	6 080	6 700	7 340	7 750	8 500			65
		4 470	5 110	5 745	6 385	7 035	7 705	8 140	8 925			50
	3 995	4 660	5 325	5 990	6 660	7 335	8 035	8 485	9 250			40
	4 200	4 895	5 595	6 290	6 990	7 705	8 440	8 915	9 775			30
	4 325	5 040	5 765	6 480	7 205	7 940	8 700	9 185	10 075			25
		7 660	8 755	9 850	10 945	12 060	13 210	13 950	15 300			10 CHO
			4 875	5 400	6 005	6 700	7 330	8 000	8 750			65
		4 545	5 120	5 670	6 305	7 035	7 695	8 400	9 190			50
	4 060	4 740	5 340	5 915	6 575	7 335	8 025	8 760	9 500			40
	4 265	4 980	5 605	6 210	6 905	7 705	8 430	9 200	10 065			30
	4 395	5 130	5 775	6 400	7 115	7 940	8 685	9 480	10 370			25
		7 795	8 775	9 725	10 805	12 060	13 195	14 400	15 750			10 CHO

All load values are valid for ground slopes up to and including 20% (11°). When operating on slopes greater than 20%, please, contact the producer.
 Load-pressure data for cyclic applications apply to low-torque transport operations at max. speeds of 10 km/h and for a max. distance of 800 meters before discharging the load and returning empty.
 By cyclic application (CHO) mean harvester's motion with full grain tank till its discharging.
 CHO: Cyclic Harvesting Operation
 Tubeless tyres – may be used with a tube.



SFT

LOAD CAPACITY	▬▬▬▬▬▬
TRACTION	▬▬▬▬▬▬
SOIL PROTECTION	▬▬▬▬▬▬
HANDLING ON ROAD	▬▬▬▬▬▬▬▬
COST EFFICIENCY	▬▬▬▬▬▬▬▬



AC70H

LOAD CAPACITY	▬▬▬▬▬▬
TRACTION	▬▬▬▬▬▬
SOIL PROTECTION	▬▬▬▬▬▬▬▬
HANDLING ON ROAD	▬▬▬▬▬▬▬▬
COST EFFICIENCY	▬▬▬▬▬▬▬▬

Harvester drive tyres: AC 70 H/G/N and Super Flexion Tyre (SFT)

Innovative tyres for gentle ground handling with harvesters



High load capacities and low inflation pressures.



Minimized load placed on soil structure, thanks to the wide and even distribution of ground pressure.



Low vibration and smooth on-road ride when moving between fields.



Very productive and cost-efficient thanks to performance in the field and in transport.

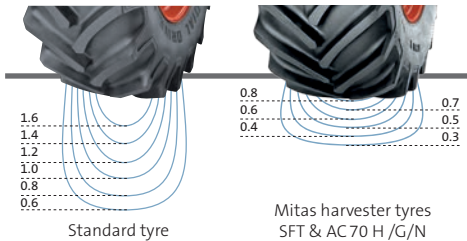

Soil compaction comparison

The extremely wide tyres distribute the weight of the machine across the surface area, lowering the compaction of the soil.



Harvester drive wheel

Technical data and load capacities

Tyre size	Tread pattern	Service description LI/SS	Rims * (permitted)	Section width (mm)	Overall diameter (mm)	Loaded static radius (mm)	Rolling circumference (mm)	Speed radius index	
1000/50 R 25	SFT	178 A8 (172 D)	36.0 TH 36.0 VA	1 020 1 020	1 655	740	4 930	750	
1000/50 R 25	SFT	175 D (178 A8)	36.0 TH 36.0 VA	1 020 1 020	1 655	740	4 930	750	
620/75 R 26	SFT	166 A8 (166 B)	DW 20 B	625	1 590	689	4 660	750	
650/75 R 32	AC 70 H	167 A8 (164 B)	DW 20 B DW 21 B	650 660	1 795	790	5 255	825	
650/75 R 32	AC 75 G	167 A8 (164 B)	DW 20 B DW 21 B	635 645	1 798	782	5 245	825	
IF 650/75 R 32 CFO°	AC 75 G	176 A8	DW 23 B DW 21 B DW 20 B	660 640 630	1 770	782	5 245	825	

SFT



AC70H



Tyre load capacity (kg) at tyre pressure (bar)											Speed (km/h)
0.6	0.8	1.0	1.2	1.4	1.6	2.0	2.4	2.8	3.2	4.0	
		3 470	3 905	4 355	4 790	5 355	5 735	6 300			65
	3 430	3 855	4 340	4 835	5 320	5 950	6 370	7 000			50
	3 830	4 250	4 780	5 270	5 800	6 445	6 900	7 500			40
	4 025	4 460	5 020	5 540	6 095	6 765	7 245	7 935			30
	4 145	4 600	5 175	5 710	6 280	6 970	7 465	8 175			25
	4 305	4 770	5 370	5 925	6 520	7 235	7 750	8 485			20
	4 550	5 045	5 675	6 265	6 890	7 650	8 190	8 970			10
	5 595	6 205	6 980	7 705	8 475	9 410	10 075	11 035			10 Cyclic
		3 940	4 365	4 835	5 300	5 885	6 300	6 900			65
	3 675	4 135	4 585	5 075	5 565	6 180	6 615	7 245			50
	3 830	4 315	4 780	5 295	5 800	6 445	6 900	7 500			40
	3 500	4 025	4 530	5 020	5 560	6 095	6 765	7 245	7 935		30
	3 605	4 145	4 670	5 175	5 730	6 280	6 970	7 465	8 175		25
	3 745	4 305	4 845	5 370	5 945	6 520	7 235	7 750	8 485		20
	3 955	4 550	5 125	5 675	6 285	6 890	7 650	8 190	8 970		10
	4 870	5 600	6 305	6 985	7 735	8 480	9 415	10 080	11 040		10 Cyclic
		2 835	3 190	3 545	3 875	4 280	4 500	4 995	5 300		50
	2 480	2 835	3 190	3 545	3 875	4 280	4 500	4 995	5 300		40
	2 655	3 035	3 415	3 795	4 145	4 580	4 815	5 345	5 670		30
	2 755	3 150	3 540	3 935	4 300	4 750	4 995	5 540	5 885		25
	3 050	3 490	3 925	4 360	4 765	5 265	5 535	6 140	6 520		20
	3 225	4 535	4 150	5 670	5 040	5 565	5 850	6 490	6 890	7 570	10
	3 970	5 580	5 105	6 975	6 200	6 845	7 200	7 990	8 480	9 320	10 Cyclic
		3 200	3 500	3 835	4 160	4 565	5 000				50
	3 245	3 515	3 850	4 215	4 500	5 020	5 450				40
	3 470	3 760	4 120	4 510	4 895	5 370	5 835				30
	3 245	3 600	3 900	4 270	4 680	5 075	5 570	6 050			25
	3 595	3 990	4 325	4 735	5 185	5 625	6 170	6 705	(3.1 bar)		20
	3 800	4 215	4 570	5 005	5 480	5 945	6 525	7 085	7 610	8 000	10
	4 675	5 190	5 625	6 155	6 745	7 315	8 030	8 725	9 370	9 845	10 Cyclic
		3 200	3 500	3 835	4 160	4 565	5 000				50
	3 245	3 515	3 850	4 215	4 500	5 020	5 450				40
	3 470	3 760	4 120	4 510	4 895	5 370	5 835				30
	3 245	3 600	3 900	4 270	4 680	5 075	5 570	6 050			25
	3 595	3 990	4 325	4 735	5 185	5 625	6 170	6 705	(3.1 bar)		20
	3 800	4 215	4 570	5 005	5 480	5 945	6 525	7 085	7 610	8 000	10
	4 675	5 190	5 625	6 155	6 745	7 315	8 030	8 725	9 370	9 845	10 Cyclic
	2 705	3 080	4 000	4 500	5 000	5 450	6 000	6 500	7 100		40
			3 520	3 960	4 400	4 795	5 280	5 720	6 250		40 Dual
			6 160	6 975	7 700	8 450	9 300	10 075	11 005		15 CFO
	4 295	4 775	5 440	6 140	6 800	7 435	8 185	8 865	9 685		15 CFO Dual

Harvester drive wheel (continued)

Technical data and load capacities

Tyre size	Tread pattern	Service description LI/SS	Rims * (permitted)	Section width (mm)	Overall diameter (mm)	Loaded static radius (mm)	Rolling circumference (mm)	Speed radius index	
650/75 R 32	AC 70 G	172 A8 (169 B)	DW 20 B DW 21 B	650 660	1 795	790	5 255	825	
680/85 R 32	AC 70 G	173 A8 (170 B)	DW 20 B DW 21 B DW 23 B	662 672 692	1 960	852	5 865	925	
680/85 R 32	AC 70 G	178 A8 (175 B)	DW 20 B DW 21 B DW 23 B	662 672 692	1 960	852	5 865	925	
800/65 R 32	AC 70 H	167 A8 (164 B)	DW 25 B DW 27 B	795 815	1 820	830	5 430	875	
800/65 R 32	AC 70 H	172 A8 (169 B)	DW 25 B DW 27 B	795 815	1 820	830	5 430	875	
800/65 R 32	AC 70 N	178 A8 (175 B)	DW 25 B DW 27 B	743 763	1 855	837	5 500	875	



AC70H

Tyre load capacity (kg) at tyre pressure (bar)												Speed (km/h)
0.6	0.8	1.0	1.2	1.4	1.6	2.0	2.4	2.8	3.2	4.0		
		3 200	3 500	3 835	4 160	4 565	5 000	5 330	5 800			50
	3 245	3 515	3 850	4 215	4 500	5 020	5 450	5 855	6 300			40
3 125	3 470	3 760	4 120	4 510	4 895	5 370	5 835	6 265	6 740			30
3 245	3 600	3 900	4 270	4 680	5 075	5 570	6 050	6 500	6 995			25
3 595	3 990	4 325	4 735	5 185	5 625	6 170	6 705	7 200	7 750			20
3 800	4 215	4 570	5 005	5 480	5 945	6 525	7 085	7 610	8 190	9 235		10
4 675	5 190	5 625	6 155	6 745	7 315	8 030	8 725	9 370	10 080	11 365		10 Cyclic
		3 865	4 230	4 635	5 025	5 515	6 000					50
	3 915	4 245	4 645	5 090	5 520	6 060	6 500					40
3 775	4 190	4 540	4 975	5 445	5 910	6 485	6 955					30
3 915	4 345	4 710	5 155	5 650	6 130	6 725	7 215					25
4 340	4 815	5 220	5 715	6 260	6 790	7 450	7 995		(3.1 bar)			20
4 585	5 090	5 520	6 040	6 620	7 175	7 875	8 450	9 190	9 655			10
5 645	6 265	6 790	7 435	8 145	8 835	9 695	10 400	11 310	11 885			10 Cyclic
		3 865	4 230	4 635	5 025	5 515	6 000	6 435	6 900			50
	3 915	4 245	4 645	5 090	5 520	6 060	6 500	7 070	7 500			40
3 775	4 190	4 540	4 975	5 445	5 910	6 485	6 955	7 565	8 025			30
3 915	4 345	4 710	5 155	5 650	6 130	6 725	7 215	7 850	8 325			25
4 340	4 815	5 220	5 715	6 260	6 790	7 450	7 995	8 695	9 225			20
4 585	5 090	5 520	6 040	6 620	7 175	7 875	8 450	9 190	9 750	11 150		10
5 645	6 265	6 790	7 435	8 145	8 835	9 695	10 400	11 310	11 995	13 720		10 Cyclic
		3 900	4 270	4 610	5 000							50
	3 950	4 285	4 690	5 065	5 450							40
3 810	4 230	4 585	5 020	5 420	5 830							30
3 955	4 385	4 755	5 205	5 625	6 050							25
4 380	4 860	5 270	5 770	6 230	6 705							20
4 630	5 140	5 570	6 100	6 585	7 085	7 630						10
5 700	6 325	6 855	7 505	8 105	8 720	9 390						10 Cyclic
		3 900	4 270	4 610	5 000	5 310	5 800					50
	3 950	4 285	4 690	5 065	5 450	5 835	6 300					40
3 810	4 230	4 585	5 020	5 420	5 830	6 245	6 745					30
3 955	4 385	4 755	5 205	5 625	6 050	6 475	6 995					25
4 380	4 860	5 270	5 770	6 230	6 705	7 175	7 750					20
4 630	5 140	5 570	6 100	6 585	7 085	7 585	8 190	8 960	(3.1 bar)			10
5 700	6 325	6 855	7 505	8 105	8 720	9 335	10 085	11 025	11 570			10 Cyclic
		3 900	4 270	4 610	5 000	5 310	5 800	6 270	6 900			50
	3 950	4 285	4 690	5 065	5 450	5 835	6 300	6 890	7 500			40
3 810	4 230	4 585	5 020	5 420	5 830	6 245	6 745	7 375	8 025			30
3 955	4 385	4 755	5 205	5 625	6 050	6 475	6 995	7 650	8 325			25
4 380	4 860	5 270	5 770	6 230	6 705	7 175	7 750	8 475	9 225			20
4 630	5 140	5 570	6 100	6 585	7 085	7 585	8 190	8 960	9 750	10 820		10
5 700	6 325	6 855	7 505	8 105	8 720	9 335	10 085	11 025	12 000	13 320		10 Cyclic

Harvester Radial Tyres

Harvester drive wheel (continued)

Technical data and load capacities

Tyre size	Tread pattern	Service description LI/SS	Rims * (permitted)	Section width (mm)	Overall diameter (mm)	Loaded static radius (mm)	Rolling circumference (mm)	Speed radius index
800/70 R 32	SFT	175 A8 (172 B)	DW 25 B DW 27 B	762 784	1 932	845	5 630	925
900/60 R 32	SFT	176 A8 (173 B)	DW 27 B DW 30 B	857 890	1 905	850	5 700	925
900/60 R 32	SFT	181 A8 (178 B)	DW 27 B DW 30 B	857 890	1 905	850	5 700	925
900/70 R 32	SFT	188 A8 (185 B)	DW 27 B DW 30 B	895 925	2 050	896	6 050	975
1050/50 R 32	SFT	178 A8 (178 B)	36.00 VA	1 015	1 890	845	5 640	875
1250/50 R 32	SFT	188 A8 (185 B)	44" 40"	1 220 1 180	2 020	890	6 000	975

SFT



	Tyre load capacity (kg) at tyre pressure (bar)											Speed (km/h)	
	0.6	0.8	1.0	1.2	1.4	1.6	2.0	2.4	2.8	3.2	4.0		
			4 180	4 575	5 010	5 460	5 965	6 300					50
		4 235	4 590	5 025	5 505	6 000	6 555	6 900					40
4 085	4 530	4 915	5 380	5 895	6 420	7 015	7 385						30
4 235	4 700	5 095	5 580	6 115	6 600	7 275	7 660						25
4 695	5 210	5 650	6 180	6 775	7 380	8 060	8 485						20
4 960	5 505	5 970	6 535	7 160	7 800	8 520	8 970		10 350				10
6 105	6 775	7 345	8 040	8 810	9 600	10 485	11 040		11 730				10 Cyclic
			4 250	4 650	5 020	5 460	5 950	6 500					50
		4 315	4 670	5 110	5 515	6 000	6 535	7 100					40
4 165	4 615	5 000	5 465	5 900	6 420	6 995	7 595						30
4 320	4 790	5 185	5 670	6 120	6 660	7 255	7 880						25
4 790	5 305	5 745	6 285	6 785	7 380	8 040	8 735						20
5 060	5 610	6 070	6 640	7 170	7 800	8 495	9 230		10 650				10
6 230	6 905	7 475	8 175	8 825	9 600	10 460	11 360		12 070				10 Cyclic
			4 250	4 650	5 020	5 460	5 950	6 500	7 025				50
		4 315	4 670	5 110	5 515	6 000	6 535	7 100	7 720	7 500			40
4 165	4 615	5 000	5 465	5 900	6 420	6 995	7 595	8 260	8 830	8 250			30
4 320	4 790	5 185	5 670	6 120	6 660	7 255	7 880	8 570	9 160				25
4 790	5 305	5 745	6 285	6 785	7 380	8 040	8 735	9 495	10 150				20
5 060	5 610	6 070	6 640	7 170	7 800	8 495	9 230	10 810	11 550		13 055		10
6 230	6 905	7 475	8 175	8 825	9 600	10 460	11 360	12 350	13 200		14 920		10 Cyclic
			4 660	5 055	5 530	6 060	6 700	7 215	7 750	8 415			50
		4 615	5 120	5 555	6 080	6 660	7 300	7 925	8 500	9 250	9 250		40
4 940	5 480	5 945	6 505	7 125	7 810	8 480	9 095	9 895	10 700	10 000			30
5 125	5 685	6 165	6 750	7 395	8 105	8 800	9 435	10 265	11 100				25
5 675	6 300	6 830	7 475	8 195	8 980	9 750	10 455	11 375	12 300				20
6 000	6 660	7 220	7 905	8 660	9 490	10 305	11 050	12 025	13 000		14 585		10
7 385	8 195	8 885	9 725	10 655	11 680	12 685	13 600	14 800	16 000		17 950		10 Cyclic
			5 045	5 515	5 955	6 500	7 055	7 500					50
		4 655	5 045	5 515	5 955	6 500	7 055	7 500					40
4 495	4 985	5 395	5 900	6 370	6 955	7 550	8 025						30
4 665	5 170	5 595	6 120	6 610	7 215	7 830	8 325						25
5 170	5 730	6 200	6 785	7 320	7 995	8 680	9 225						20
5 465	6 055	6 555	7 170	7 740	8 450	9 175	9 750		11 250				10
6 725	7 450	8 070	8 825	9 525	10 400	11 290	12 000		12 750				10 Cyclic
			5 020	5 655	6 265	6 960	7 750	8 500	9 250				50
		4 730	5 515	6 210	6 885	7 650	8 500	9 340	10 000				40
5 060	5 905	6 645	7 265	8 185	9 095	9 995	10 700						30
5 250	6 125	6 895	7 640	8 490	9 435	10 370	11 100						25
5 815	6 785	7 640	8 470	9 410	10 455	11 490	12 300						20
6 620	7 725	8 695	9 640	10 710	11 900	13 075	14 000						10
7 565	8 825	9 940	11 015	12 240	13 600	14 945	16 000		17 655				10 Cyclic

Harvester drive wheel (continued)

Technical data and load capacities

Tyre size	Tread pattern	Service description LI/SS	Rims * (permitted)	Section width (mm)	Overall diameter (mm)	Loaded static radius (mm)	Rolling circumference (mm)	Speed radius index
1250/50 R 32	SFT	194 A8 (191 B)	44" 40"	1 220 1 180	2 020	890	6 000	975
900/60 R 38	SFT	178 D (181 A8)	DW 27 B DW 30 B	870 900	2 060	918	6 115	975
580/85 R 42	SFT	163 D (166 A8)	W 18 L DW 20 B DW 21 B	567 587 597	2 045	920	6 100	975
680/80 R 42	SFT	180 D (183 A8)	DW 21 B DW 23 B DW 20 B	660 680 650	2 160	965	6 400	1 025

* Further admissible rims on request

° In preparation, please contact Mitas for availability

Load values for 0.6 bar are for calculating dual and triple load values only.

30 km/h (up to 40 km/h) load values also apply for low-speed high-torque field work.

For plowing with single driven tyres in the furrow, a minimum inflation pressure of 0.8 bar is required.

For intensive road transport at 65/50/40/30 km/h the pressure must be increased by 0.4 bar. Maximum inflation pressure should never be exceeded.

All load values are valid for ground slopes up to and including 20% (11°). When operating on slopes greater than 20%, please, contact the producer.

Load-pressure data for cyclic applications apply to low-torque transport operations at max. speeds of 10 km/h and for a max. distance of 800 meters before

discharging the load and returning empty.

By cyclic application is means harvester's motion with full grain tank till its discharging.

Tubeless tyres – may be used with a tube.

SFT



Tyre load capacity (kg) at tyre pressure (bar)											Speed (km/h)	
0.6	0.8	1.0	1.2	1.4	1.6	2.0	2.4	2.8	3.2	4.0		
												50
4 730	5 020	5 655	6 265	6 960	7 750	8 500	9 250	10 040	10 900			40
5 060	5 515	6 210	6 885	7 650	8 500	9 340	10 000	11 035	11 800			30
5 250	5 905	6 645	7 265	8 185	9 095	9 995	10 700	11 805	12 625			25
5 815	6 125	6 895	7 640	8 490	9 435	10 370	11 100	12 245	13 100			20
6 620	6 785	7 640	8 470	9 410	10 455	11 490	12 300	13 570	14 515			10
7 565	7 725	8 695	9 640	10 710	11 900	13 075	14 000	15 445	16 520			10 Cyclic
	8 825	9 940	11 015	12 240	13 600	14 945	16 000	17 655	18 880			
		4 875	5 325	5 825	6 300	6 985	7 500					65
	4 610	5 120	5 595	6 115	6 615	7 335	7 875					50
4 235	4 805	5 340	5 835	6 375	6 900	7 650	8 250					40
4 450	5 050	5 605	6 125	6 695	7 245	8 035	8 625					30
4 585	5 200	5 780	6 315	6 900	7 465	8 280	8 890					25
4 755	5 400	5 995	6 555	7 165	7 750	8 590	9 225					20
5 415	6 145	6 825	7 460	8 155	8 820	9 780	10 500	11 250				10
6 190	7 025	7 800	8 525	9 315	10 080	11 175	12 000	12 750				10 Cyclic
		3 605	3 945	4 405	4 875							65
	3 405	3 785	4 140	4 630	5 120							50
3 125	3 550	3 950	4 320	4 825	5 300							40
3 285	3 730	4 145	4 535	5 070	5 605							30
3 375	3 834	4 266	4 666	5 211	5 724							25
3 500	3 976	4 424	4 838	5 404	5 936							20
3 995	4 540	5 050	5 520	6 170	6 825	7 260						10
4 570	5 190	5 770	6 310	7 050	7 800	8 290						10 Cyclic
		4 495	4 920	5 390	5 800	6 415	6 900	7 490	8 000			65
3 920	4 350	4 720	5 165	5 660	6 090	6 735	7 245	7 865	8 400			50
4 090	4 540	4 920	5 385	5 900	6 300	7 025	7 500	8 200	8 750			40
4 295	4 765	5 170	5 660	6 200	6 670	7 375	7 935	8 615	9 200			30
4 425	4 910	5 325	5 830	6 385	6 875	7 600	8 175	8 875	9 480			25
4 595	5 100	5 530	6 055	6 630	7 135	7 895	8 485	9 210	9 840			20
4 855	5 390	5 845	6 400	7 010	7 540	8 345	8 970	9 735	10 400	11 810		10
5 980	6 635	7 195	7 875	8 625	9 280	10 270	11 040	11 980	12 800	14 535		10 Cyclic



SFT IMP

LOAD CAPACITY	▬ ▬ ▬ ▬ ▬ ▬ ▬ ▬
TRACTION	▬ ▬ ▬ ▬ ▬ ▬ ▬ ▬
SOIL PROTECTION	▬ ▬ ▬ ▬ ▬ ▬ ▬ ▬
HANDLING ON ROAD	▬ ▬ ▬ ▬ ▬ ▬ ▬ ▬
COST EFFICIENCY	▬ ▬ ▬ ▬ ▬ ▬ ▬ ▬



AC 65 IMP

LOAD CAPACITY	▬ ▬ ▬ ▬ ▬ ▬ ▬ ▬
TRACTION	▬ ▬ ▬ ▬ ▬ ▬ ▬ ▬
SOIL PROTECTION	▬ ▬ ▬ ▬ ▬ ▬ ▬ ▬
HANDLING ON ROAD	▬ ▬ ▬ ▬ ▬ ▬ ▬ ▬
COST EFFICIENCY	▬ ▬ ▬ ▬ ▬ ▬ ▬ ▬



AC 70 G IMP

LOAD CAPACITY	▬ ▬ ▬ ▬ ▬ ▬ ▬ ▬
TRACTION	▬ ▬ ▬ ▬ ▬ ▬ ▬ ▬
SOIL PROTECTION	▬ ▬ ▬ ▬ ▬ ▬ ▬ ▬
HANDLING ON ROAD	▬ ▬ ▬ ▬ ▬ ▬ ▬ ▬
COST EFFICIENCY	▬ ▬ ▬ ▬ ▬ ▬ ▬ ▬

Super Flexion Tyre (SFT IMP), AC 65 IMP & AC 70 G IMP

Tremendous flexion and load capacity make these tyres a great fit for the steering axle of a harvester



Outstanding traction thanks to very large ground contact patch.



High load capacity and optimal ground pressure distribution reduces soil compaction.



Long tyre life through optimized tread pattern design and high resistance to damage.



Suitable also for free-rolling field applications.



Harvester Steering wheel

Technical data and load capacities

Tyre size	Tread pattern	Tube Valve	Rims * (permitted)	Section width (mm)	Overall diameter (mm)	Loaded static radius (mm)	Rolling circumference (mm)	
460/70 R 24 IMP	AC 70 G	–	W 15 L W 16 L W 14 L	455 465 445	1 236	552 ☺ 528 ☺☹	3 690 ☺ 3 620 ☺☹	
500/70 R 24 IMP	AC 70 G	–	W 16 L W 15 L	496 486	1 313	591 ☺ 573 ☺☹	3 919 ☺ 3 908 ☺☹	
500/85 R 24 IMP	SFT	S 18.4(15)-26 T 47GW S	W 16 L W 15 L	528 518	1 458	650 ☺ 621 ☺☹	4 325 ☺ 4 237 ☺☹	
500/85 R 24 IMP	SFT	S 18.4(15)-26 T 47GW S	W 16 L W 15 L	546 536	1 458	645 ☺ 615 ☺☹	4 315 ☺ 4 225 ☺☹	
500/85 R 24 IMP	SFT	S 18.4(15)-26 T 47GW S	W 16 L W 15 L	527 517	1 461	645 ☺ 615 ☺☹	4 315 ☺ 4 225 ☺☹	
620/55 R 26 IMP ^o	SFT	–	DW 20 B D(W) 18 L DW 21 B	605 585 615	1 342	620 ☺ 600 ☺☹	4 055 ☺ 3 995 ☺☹	
500/80 R 28 IMP	SFT	S 18.4(15)-26 T 47GW S	W 16 L W 15 L	517 507	1 495	663 ☺ 635 ☺☹	4 440 ☺ 4 355 ☺☹	
500/80 R 28 IMP	SFT	S 18.4(15)-26 T 47GW S	W 16 L W 15 L	517 507	1 495	663 ☺ 635 ☺☹	4 440 ☺ 4 355 ☺☹	
600/65 R 28 IMP	AC 65	S 18.4(15)-26 T 47GW S	W 18 L DW 18 L W 16 L	590 590 570	1 485	661 ☺ 640 ☺☹	4 411 ☺ 4 340 ☺☹	
600/65 R 28 IMP	AC 65	S 18.4(15)-26 T 47GW S	W 18 L DW 18 L W 16 L	590 590 570	1 485	661 ☺ 640 ☺☹	4 411 ☺ 4 340 ☺☹	
500/85 R 30 IMP	SFT	S 18.4(15)-26 T 47GW S	W 16L W 15L	527 517	1 605	711 ☺ 680 ☺☹	4 750 ☺ 4 669 ☺☹	
500/85 R 30 IMP	SFT N	S 18.4(15)-26 T 47GW S	W 16L W 15L	506 496	1 606	711 ☺ 680 ☺☹	4 750 ☺ 4 669 ☺☹	
540/65 R 30 IMP	AC 65	–	W 16 L W 18 L W 15 L	526 546 516	1 485	664 ☺ 648 ☺☹	4 420 ☺ 4 365 ☺☹	
620/70 R 30 IMP	SFT	–	W 18 L DW 20 B DW 21 B	625 645 655	1 595	700 ☺ 680 ☺☹	4 870 ☺ 4 770 ☺☹	
620/70 R 30 IMP	SFT N	–	W 18 L DW 20 B DW 21 B	600 620 630	1 595	700 ☺ 680 ☺☹	4 870 ☺ 4 770 ☺☹	
620/75 R 30 IMP	SFT	–	W 18 L DW 20 B DW 21 B	590 610 620	1 692	753 ☺ 730 ☺☹	5 000 ☺ 4 950 ☺☹	

AC 70 G



AC 65



SFT



	Service description LI/SS	Tyre load capacity (kg) at tyre pressure (bar)								Speed (km/h)	
		0.8	1.2	1.6	2.0	2.4	2.8	3.2	3.6		4.0
	151 A8 ⊕ 163 A8 ⊕→	1 350 1 905	1 735 2 450	2 120 2 995	2 455 3 465	2 790 3 940	3 110 4 395	3 450 4 875			40 40
	155 A8 ⊕ 167 A8 ⊕→	1 685 2 360	2 165 3 030	2 645 3 700	3 065 4 300	3 480 4 875	3 875 5 450				40 40
	158 A8 ⊕ 171 A8 ⊕→	1 795 2 600	2 310 3 340	2 820 4 085	3 270 4 730	3 715 5 375	4 250 6 150				40 40
	165 A8 ⊕ 177 A8 ⊕→		2 310 3 340	2 820 4 085	3 270 4 730	3 715 5 375	4 250 6 150	4 675 6 630	5 150 7 300		40 40
	161 A8 ⊕ 182 A8 ⊕→		2 430 3 550	3 000 4 250	3 350 5 000	3 550 5 800	3 875 6 500	4 125 6 900	4 375 7 750	4 625 8 500	40 40
	150 A8 ⊕ 168 A8 ⊕→	1 750 2 650	2 240 3 450	2 800 4 250	4 250 5 950	3 075 4 875	3 350 5 600				40 40
	164 A8 ⊕ 176 A8 ⊕→	1 940 2 755	2 495 3 540	3 050 4 330	3 530 5 015	4 015 5 700	4 480 6 360	5 000 7 100			40 40
	162 A8 ⊕ 182 A8 ⊕→		2 500 3 550	3 000 4 375	3 350 5 000	3 550 5 800	3 875 6 500	4 125 7 100	4 500 7 750	4 750 8 500	40 40
	156 A8 ⊕ 168 A8 ⊕→	2 170 3 040	2 790 3 910	3 410 4 775	4 000 5 600						40 40
	157 A8 ⊕ 177 A8 ⊕→	2 120 3 075	2 650 3 875	3 150 4 750	3 550 5 600	3 750 6 300	4 125 7 300				40 40
	164 A8 ⊕ 176 A8 ⊕→	2 110 2 995	2 715 3 855	3 315 4 710	3 840 5 455	4 365 6 200	5 000 7 100				40 40
	164 A8 ⊕ 176 A8 ⊕→	2 110 2 995	2 715 3 855	3 315 4 710	3 840 5 455	4 365 6 200	5 000 7 100				40 40
	156 A8 ⊕ 168 A8 ⊕→	1 900 2 660	2 445 3 420	2 985 4 180	3 460 4 840	4 000 5 600					40 40
	166 A8 ⊕ 178 A8 ⊕→	2 490 3 525	3 205 4 535	3 915 5 540	4 535 6 415	5 300 7 500					40 40
	166 A8 ⊕ 178 A8 ⊕→	2 490 3 525	3 205 4 535	3 915 5 540	4 535 6 415	5 300 7 500					40 40
	168 A8 ⊕ 180 A8 ⊕→	2 620 3 750	3 410 4 875	4 200 6 000	4 825 6 900	5 600 8 000					40 40

Harvester Steering wheel (continued)

Technical data and load capacities

Tyre size	Tread pattern	Tube Valve	Rims * (permitted)	Section width (mm)	Overall diameter (mm)	Loaded static radius (mm)	Rolling circumference (mm)	
710/60 R 30 IMP	SFT	–	DW 21 B DW 23 B	690 710	1 625	724 ☉ 680 ☉➔	4 830 ☉ 4 690 ☉➔	
710/65 R 30 IMP	SFT	–	DW 23 B DW 25 B	708 728	1 698	755 ☉ 730 ☉➔	5 000 ☉ 4 950 ☉➔	
500/85 R 34 IMP	SFT	–	W 16 L W 15 L	503 493	1 705	755 ☉ 745 ☉➔	5 050 ☉ 5 000 ☉➔	
500/85 R 34 IMP	SFT N	–	W 16 L W 15 L	506 496	1 706	755 ☉ 745 ☉➔	5 050 ☉ 5 000 ☉➔	

* Further admissible rims on request

☉ In preparation, please contact Mitas for availability

☉ – drive wheel

☉➔ – free rolling wheel

When fitted on tractor steering axle, 80% of load “free rolling” applies

For intensive road transport at 40/30 km/h the pressure must be increased by 0.4 bar. Maximum inflation pressure should never be exceeded.

All load values are valid for ground slopes up to and including 20% (11°). When operating on slopes greater than 20%, please, contact the producer.

Tubeless tyres – may be used with a tube.

SFT



	Service description L/SS	Tyre load capacity (kg) at tyre pressure (bar)									Speed (km/h)
		0.8	1.2	1.6	2.0	2.4	2.8	3.2	3.6	4.0	
162 A8 ⊕	2 580	3 220	3 875	4 385	4 750						40
180 A8 ⊕→	3 795	4 880	5 965	6 905	8 000						40
165 A8 ⊕	2 855	3 570	4 250	4 735	5 150						40
182 A8 ⊕→	4 080	5 250	6 415	7 430	8 500						40
166 A8 ⊕	2 555	3 195	3 515	4 070	4 630	5 300					40
178 A8 ⊕→	3 620	4 525	4 975	5 760	6 550	7 500					40
166 A8 ⊕	2 555	3 195	3 515	4 070	4 630	5 300					40
178 A8 ⊕→	3 620	4 525	4 975	5 760	6 550	7 500					40

Conversion table

Size designation in Inches	Size designation in millimetres				Speed radius index
	95–85 series	80 series	75 series	70 series	
				200/70 R 16 AC 70 T	330
				240/70 R 16 AC 70 T	350
				260/70 R 16 AC 70 T	360
				280/70 R 16 AC 70 T	390
				280/70 R 18 AC 70 T	410
				280/70 R 20 AC 70 T	425
				300/70 R 20 AC 70 T	450
11.2 R 20	280/85 R 20 AC 85			320/70 R 20 AC 70 T	475
				360/70 R 20 AC 70 T	500
11.2 R 24	280/85 R 24 AC 85			380/70 R 20 AC 70 T	525
				320/70 R 24 HC 70 / AC 70 T	525
12.4 R 24	320/85 R 24 AC 85			360/70 R 24 HC 70 / AC 70 T	550
13.6 R 24	340/85 R 24 AC 85			380/70 R 24 HC 70 / AC 70 T	575
11.2 R 28	280/85 R 28 AC 85			/ AC 70 G	
14.9 R 24	380/85 R 24 AC 85			420/70 R 24 HC 70 / AC 70 T	600
12.4 R 28	320/85 R 28 AC 85			/ AC 70 G	
16.9 R 24	420/85 R 24 AC 85	440/80 R 24 HCM		480/70 R 24 HC 70 / AC 70 T	625
				/ AC 70 G	
13.6 R 28	340/85 R 28 AC 85			380/70 R 28 HC 70 / AC 70 T	625
14.9 R 28	380/85 R 28 AC 85	400/80 R 28 HCM		420/70 R 28 HC 70 / AC 70 T	650
				/ AC 70 G	
16.9 R 28	420/85 R 28 AC 85	440/80 R 28 HCM		480/70 R 28 HC 70 / AC 70 T	675
14.9 R 30	380/85 R 30 AC 85			420/70 R 30 HC 70 / AC 70 T	
16.9 R 30	420/85 R 30 AC 85			480/70 R 30 HC 70	700
				480/70 R 30 AC 70 T / AC 70 G	
18.4 R 30	460/85 R 30 AC 85			600/70 R 28 SFT	725
14.9 R 34	380/85 R 34 AC 85				
16.9 R 34	VF 420/85 R 34 HC 2000	380/80 R 38 AC 85	620/75 R 26 SFT	VF 600/70 R 30 HC 2000	750
	420/85 R 34 AC 85			600/70 R 30 SFT	
13.6 R 38	340/85 R 38 AC 85			480/70 R 34 HC 70	
				/ AC 70 T / AC 70 G	
18.4 R 34	460/85 R 34 AC 85			520/70 R 34 HC 70	775
				/ AC 70 T / AC 70 G	
16.9 R 38	VF 380/95 R 38 HC 2000			VF 480/70 R 38 HC 2000	800
	420/85 R 38 AC 85			480/70 R 38 HC 70 / AC 70 T	
18.4 R 38	460/85 R 38 AC 85	480/80 R 38 HCM	IF 650/75 R 32 AC 75 G	520/70 R 38 HC 70 / AC 70 T	825
			650/75 R 32 AC 70 H	/ AC 70 G	
			650/75 R 32 AC 75 G		

	Size designation in millimetres				Size designation in Inches	Speed radius index
	65 series	60 series	55–50 series	Row Crop		
						330
						350
						360
	320/65 R 16 AC 65					390
						410
						425
						450
						475
	420/65 R 20 AC 65					500
						525
						550
	440/65 R 24 AC 65					575
	480/65 R 24 AC 65			270/80 R 32 AC 90	9.5 R 32	600
	540/65 R 24 AC 65			270/95 R 32 AC 85		625
	440/65 R 28 AC 65					
	480/65 R 28 AC 65			320/85 R 32 AC 85 270/80 R 36 AC 90	12.4 R 32 9.5 R 36	650
	540/65 R 28 SFT 540/65 R 28 AC 65			320/90 R 32 AC 85 320/85 R 34 AC 85	12.4 R 34	675
	600/65 R 28 SFT 600/65 R 28 AC 65 540/65 R 30 SFT 540/65 R 30 AC 65					700
	600/65 R 30 AC 65		710/55 R 30 SFT	320/85 R 38 AC 85 13.6 R 36 AC 90	12.4 R 38	725
	750/65 R 26 SFT 540/65 R 34 AC 65	VF 540/65 R 34 HC 2000 710/60 R 30 SFT	1000/50 R 25 SFT 750/55 R 30 SFT	340/85 R 38 AC 85 300/85 R 42 AC 90 15.5 R 38 AC 51	13.6 R 38 11.2 R 42	750
	600/65 R 34 AC 65	650/60 R 34 SFT		300/95 R 42 AC 90	12.4 R 42	775
	540/65 R 38 AC 65			IF 320/90 R 42 AC 85 320/90 R 42 AC 85 380/95 R 38 AC 85		800
	650/65 R 34 SFT 600/65 R 38 SST / AC 65	710/60 R 34 SFT		320/95 R 46 AC 85 270/95 R 48 AC 90	11.2 R 48	825

Conversion table (continued)

Size designation in Inches	Size designation in millimetres				Speed radius index	
	95–85 series	80 series	75 series	70 series		
20.8 R 38	520/85 R 38 AC 85	VF 580/80 R 34 HC 3000 480/80 R 42 AC 85		580/70 R 38 HC 70 580/70 R 38 AC 70 T	875	
20.8 R 42	520/85 R 42 AC 85 680/85 R 32 CHO AC 70 G 680/85 R 32 AC 70 G	480/80 R 46 AC 85	650/75 R 38 SFT	710/70 R 38 SFT 710/70 R 38 AC 65 710/70 R 38 SST 800/70 R 32 CHO SFT 800/70 R 32 SFT	925	
20.8 R 46	650/85 R 38 SFT 580/85 R 42 SFT 520/85 R 46 AC 85	VF 480/80 R 50 HC 1000 480/80 R 50 AC 85	650/75 R 42 SFT	800/70 R 38 SFT VF 710/70 R 42 HC 2000 710/70 R 42 SFT 710/70 R 42 SST 900/70 R 32 CHO SFT 900/70 R 32 SFT 800/70 R 38 CHO SFT	975	
		680/80 R 42 CHO SFT 680/80 R 42 SFT	710/75 R 42 SFT 710/75 R 42 SST		1 025	
	VF 480/95 R 50 HC 2000 480/95 R 50 AC 85				1 075	

	Size designation in millimetres				Size designation in Inches	Speed radius index
	65 series	60 series	55–50 series	Row Crop		
	650/65 R 38 SFT 650/65 R 38 SST / AC 65 800/65 R 32 AC 70 H 800/65 R 32 AC 70 N		1050/50 R 32 SFT	VF 380/90 R 46 HC 1000 380/90 R 46 AC 85 340/90 R 48 AC 85 320/90 R 50 AC 85	14.9 R 46 13.6 R 48	875
	650/65 R 42 SST / AC 65	900/60 R 32 CHO SFT 900/60 R 32 SFT				925
		900/60 R 38 CHO SFT 900/60 R 38 SFT	1250/50 R 32 SFT	VF 320/105 R 54 HC 1000 VF 380/105 R 50 HC 1000 380/90 R 50 AC 85 320/90 R 54 AC 85	14.9 R 50	975
	VF 1000/65 R 32 HC 3000 R IF 710/65 R 46 SFT 710/65 R 46 SFT	900/60 R 42 SFT		380/105 R 54 AC 85 380/90 R 54 AC 85		1 025
						1 075



Agriterra 02

LOAD CAPACITY	=====
ROAD PERFORMANCE	=====
FIELD PERFORMANCE	=====
SELF-CLEANING	=====
RESISTANCE	=====



Agriterra 03

LOAD CAPACITY	=====
ROAD PERFORMANCE	=====
FIELD PERFORMANCE	=====
SELF-CLEANING	=====
RESISTANCE	=====



Agriterra 04

LOAD CAPACITY	=====
ROAD PERFORMANCE	=====
FIELD PERFORMANCE	=====
SELF-CLEANING	=====
RESISTANCE	=====

Agriterra

New generation of fast and powerful agricultural tyres



Agriterra 02 and 04 – **Gentle to grassland** due to high positive share and round shoulder.



Agriterra 03 – **Excellent self-cleaning properties** due to higher negative share and distinctive shoulder.



Low noise emission thanks optimized tread pattern.



Wide agricultural use: flat trucks, fast-moving agricultural trailers, tank containers etc.

The bigger tread pattern contact area

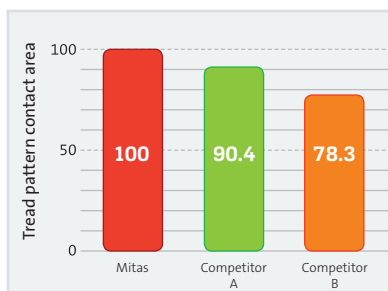

High operating economy on the road and in the field

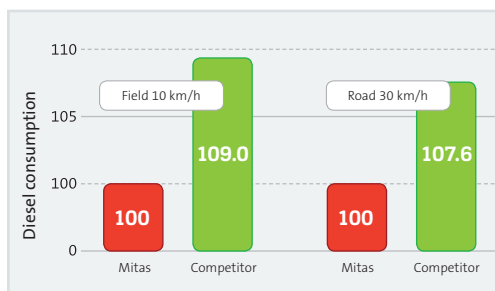

Tested tyre size 600/55 R 26.5 IMP



Agriterra

Technical data and load capacities

Tyre size	Tread pattern	Service description LI/SS	Rims * (permitted)	Section width (mm)	Overall diameter (mm)	Loaded static radius (mm)	Rolling circumference (mm)
500/60 R 22.5 IMP	Agriterra 02	161 D	AG 16.00 × 22.5 15.00 × 22.5 16.00 × 22.5 17.00 × 22.5	524	1 172	543	3 547
560/45 R 22.5 IMP	Agriterra 02	152 D	AG 16.00 × 22.5	564	1 076	495	3 228
560/60 R 22.5 IMP	Agriterra 02	165 D	AG 16.00 × 22.5 AG 20.00 × 22.5 16.00 × 22.5 17.00 × 22.5	567 607	1 247	568	3 743
600/50 R 22.5 IMP	Agriterra 02	163 D	AG 20.00 × 22.5	631	1 173	537	3 530
600/50 R 22.5 IMP	Agriterra 02	167 D	AG 20.00 × 22.5	631	1 173	537	3 530
710/45 R 22.5 IMP	Agriterra 02	165 D	AG 24.00 × 22.5 AG 20.00 × 22.5	729	1 208	545	3 610
600/55 R 26.5 IMP	Agriterra 02	165 D	AG 20.00 × 26.5	626	1 335	585	4 033
650/55 R 26.5 IMP	Agriterra 02	169 D	AG 20.00 × 26.5	653	1 383	627	4 142

Agriterra 02



Agriterra 03



Agriterra 04



	Tyre load capacity (kg) at tyre pressure (bar)										Speed (km/h)
	1.0	1.2	1.6	2.0	2.4	2.8	3.2	3.6	4.0	5.0	
1 730	1 935	2 335	2 735	3 135	3 320	3 505	3 690	3 875	4 125	4 625	65
2 093	2 341	2 825	3 309	3 793	4 017	4 241	4 465	4 689	4 991	5 596	50
2 353	2 632	3 176	3 720	4 264	4 515	4 767	5 018	5 270	5 610	6 290	40
2 612	2 922	3 526	4 130	4 734	5 013	5 293	5 572	5 851	6 229	6 984	30
3 114	3 483	4 203	4 923	5 643	5 976	6 309	6 642	6 975	7 425	8 325	10
1 325	1 480	1 770	2 060	2 360	2 655	2 955	3 250	3 550			65
1 605	1 795	2 145	2 495	2 860	3 215	3 580	3 935	4 300			50
1 805	2 015	2 410	2 805	3 210	3 615	4 020	4 420	4 830			40
2 005	2 235	2 675	3 115	3 565	4 010	4 465	4 910	5 365			30
2 385	2 665	3 190	3 710	4 250	4 780	5 320	5 850	6 390			10
2 065	2 305	2 785	3 265	3 745	3 965	4 185	4 405	4 625	5 150		65
2 499	2 789	3 370	3 951	4 531	4 798	5 064	5 330	5 596	6 232		50
2 808	3 135	3 788	4 440	5 093	5 392	5 692	5 991	6 290	7 004		40
3 118	3 481	4 205	4 930	5 655	5 987	6 319	6 652	6 984	7 777		30
3 717	4 149	5 013	5 877	6 741	7 137	7 533	7 929	8 325	9 270		10
1 950	2 175	2 630	3 085	3 535	3 745	3 955	4 165	4 375	4 875		65
2 360	2 632	3 182	3 733	4 277	4 531	4 786	5 040	5 294	5 899		50
2 652	2 958	3 577	4 196	4 808	5 093	5 379	5 664	5 950	6 630		40
2 945	3 284	3 971	4 658	5 338	5 655	5 972	6 289	6 606	7 361		30
3 510	3 915	4 734	5 553	6 363	6 741	7 119	7 497	7 875	8 775		10
1 950	2 175	2 630	3 085	3 535	3 745	3 955	4 165	4 375	4 875	5 450	65
2 360	2 632	3 182	3 733	4 277	4 531	4 786	5 040	5 294	5 899	6 595	50
2 652	2 958	3 577	4 196	4 808	5 093	5 379	5 664	5 950	6 630	7 412	40
2 945	3 284	3 971	4 658	5 338	5 655	5 972	6 289	6 606	7 361	8 230	30
3 510	3 915	4 734	5 553	6 363	6 741	7 119	7 497	7 875	8 775	9 810	10
2 060	2 310	2 820	3 330	3 840	4 170	4 500	4 825	5 150			65
2 493	2 795	3 412	4 029	4 646	5 046	5 445	5 838	6 232			50
2 802	3 142	3 835	4 529	5 222	5 671	6 120	6 562	7 004			40
3 111	3 488	4 258	5 028	5 798	6 297	6 795	7 286	7 777			30
3 708	4 158	5 076	5 994	6 912	7 506	8 100	8 685	9 270			10
2 290	2 560	3 100	3 640	4 180	4 425	4 670	4 910	5 150			65
2 771	3 098	3 751	4 404	5 058	5 354	5 651	5 941	6 232			50
3 114	3 482	4 216	4 950	5 685	6 018	6 351	6 678	7 004			40
3 458	3 866	4 681	5 496	6 312	6 682	7 052	7 414	7 777			30
4 122	4 608	5 580	6 552	7 524	7 965	8 406	8 838	9 270			10
2 590	2 890	3 490	4 095	4 700	4 975	5 250	5 525	5 800			65
3 134	3 497	4 223	4 955	5 687	6 020	6 353	6 685	7 018			50
3 522	3 930	4 746	5 569	6 392	6 766	7 140	7 514	7 888			40
3 911	4 364	5 270	6 183	7 097	7 512	7 928	8 343	8 758			30
4 662	5 202	6 282	7 371	8 460	8 955	9 450	9 945	10 440			10

Agriterra (continued)

Technical data and load capacities

Tyre size	Tread pattern	Service description LI/SS	Rims * (permitted)	Section width (mm)	Overall diameter (mm)	Loaded static radius (mm)	Rolling circumference (mm)
650/65 R 26.5 IMP	Agriterra 02	174 D	AG 20.00 × 26.5	675	1 516	683	4 527
710/50 R 26.5 IMP	Agriterra 02	170 D	AG 24.00 × 26.5 AG 20.00 × 26.5	737	1 388	628	4 189
800/45 R 26.5 IMP	Agriterra 02	174 D	AG 24.00 × 26.5 AG 28.00 × 26.5	770	1 394	628	4 163
600/60 R 30.5 IMP	Agriterra 04	173 D	AG 20.00 × 30.5	625	1 500	690	4 524
680/60 R 30.5 IMP	Agriterra 03	176 D	AG 20.00 × 30.5	697	1 623	740	4 875
750/60 R 30.5 IMP	Agriterra 03	181 D	AG 24.00 × 30.5	792	1 672	755	4 998
850/50 R 30.5 IMP	Agriterra 02	182 D	AG 28.00 × 30.5	880	1 620	732	4 844
800/65 R 32 IMP	Agriterra 04	185 D	DW 25 B DW 23 B DW 27 B DW 28 B	785 765 805 815	1 859	835	5 442

* Further admissible rims on request

For intensive road transport at 65/50/40/30 km/h the pressure must be increased by 0.4 bar. Maximum inflation pressure should never be exceeded. All load values are valid for ground slopes up to and including 20% (11°). When operating on slopes greater than 20%, please, contact the producer. Tubeless tyres – may be used with a tube.

Agriterra 02



Agriterra 03



Agriterra 04



	Tyre load capacity (kg) at tyre pressure (bar)										Speed (km/h)
	1.0	1.2	1.6	2.0	2.4	2.8	3.2	3.6	4.0	5.0	
2 670	3 000	3 660	4 320	4 980	5 410	5 840	6 270	6 700			65
3 231	3 630	4 429	5 227	6 026	6 546	7 066	7 587	8 107			50
3 631	4 080	4 978	5 875	6 773	7 358	7 942	8 527	9 112			40
4 032	4 530	5 527	6 523	7 520	8 169	8 818	9 468	10 117			30
4 806	5 400	6 588	7 776	8 964	9 738	10 512	11 286	12 060			10
2 690	3 000	3 620	4 240	4 860	5 145	5 430	5 715	6 000			65
3 255	3 630	4 380	5 130	5 881	6 225	6 570	6 915	7 260			50
3 658	4 080	4 923	5 766	6 610	6 997	7 385	7 772	8 160			40
4 062	4 530	5 466	6 402	7 339	7 769	8 199	8 630	9 060			30
4 842	5 400	6 516	7 632	8 748	9 261	9 774	10 287	10 800			10
2 670	3 000	3 660	4 320	4 980	5 410	5 840	6 270	6 700			65
3 231	3 630	4 429	5 227	6 026	6 546	7 066	7 587	8 107			50
3 631	4 080	4 978	5 875	6 773	7 358	7 942	8 527	9 112			40
4 032	4 530	5 527	6 523	7 520	8 169	8 818	9 468	10 117			30
4 806	5 400	6 588	7 776	8 964	9 738	10 512	11 286	12 060			10
2 590	2 890	3 490	4 095	4 700	4 975	5 250	5 525	5 800	6 500		65
3 135	3 495	4 225	4 955	5 685	6 020	6 355	6 685	7 020	7 865		50
3 520	3 930	4 745	5 570	6 390	6 765	7 140	7 515	7 890	8 840		40
3 910	4 365	5 270	6 185	7 095	7 510	7 930	8 345	8 760	9 815		30
4 660	5 200	6 280	7 370	8 460	8 955	9 450	9 945	10 440	11 700		10
3 170	3 540	4 280	5 020	5 760	6 095	6 430	6 765	7 100			65
3 840	4 285	5 180	6 075	6 970	7 375	7 785	8 190	8 595			50
4 315	4 815	5 825	6 830	7 835	8 290	8 745	9 205	9 660			40
4 790	5 350	6 465	7 585	8 700	9 205	9 710	10 220	10 725			30
5 710	6 375	7 705	9 040	10 370	10 975	11 575	12 180	12 780			10
3 680	4 110	4 970	5 830	6 690	7 080	7 470	7 860	8 250			65
4 453	4 973	6 014	7 054	8 095	8 567	9 039	9 511	9 983			50
5 005	5 590	6 759	7 929	9 098	9 629	10 159	10 690	11 220			40
5 557	6 206	7 505	8 803	10 102	10 691	11 280	11 869	12 458			30
6 624	7 398	8 946	10 494	12 042	12 744	13 446	14 148	14 850			10
3 400	3 820	4 660	5 500	6 340	6 880	7 420	7 960	8 500			65
4 114	4 622	5 639	6 655	7 671	8 325	8 978	9 632	10 285			50
4 624	5 195	6 338	7 480	8 622	9 357	10 091	10 826	11 560			40
5 134	5 768	7 037	8 305	9 573	10 389	11 204	12 020	12 835			30
6 120	6 876	8 388	9 900	11 412	12 384	13 356	14 328	15 300			10
	4 500	5 450	6 150	6 900	7 750	8 500	9 250				65
	5 445	6 595	7 440	8 350	9 380	10 285	11 195				50
	6 120	7 410	8 365	9 385	10 540	11 560	12 580				40
	6 795	8 230	9 285	10 420	11 705	12 835	13 970				30
	8 100	9 810	11 070	12 420	13 950	15 300	16 650				10



AR-01

Approved for high speed up to 80 km/h. Reduced fuel consumption. Prolonged working life.



AR-02

High-grip thanks to robust lugs. Optimal pressure distribution. Balanced handling on and off the road.



AR-03

Radial tyre designed for use on fastmoving self-loading forage boxes and trailers at speeds of up to 65 km/h. The larger footprint and low tyre pressure protect both grassland and soil. The tyre is also suitable for utility vehicles.



AR-04

Radial traction tyre for use on grassland. Ideally suited for working on slopes. Very quiet running on roads at speeds of up to 65 km/h. High mileage performance through optimist tread pattern design.



AR-05

The longitudinal and lateral structure of the tread pattern, combined with rounded tread shoulders, ensures low rolling resistance. The all-steel construction protects the tyre from damage. Approved for speeds of up to 100 km/h.

AR – Agricultural radial tyres with high load capacity and working speed

Main applications – Trailer radial tyres

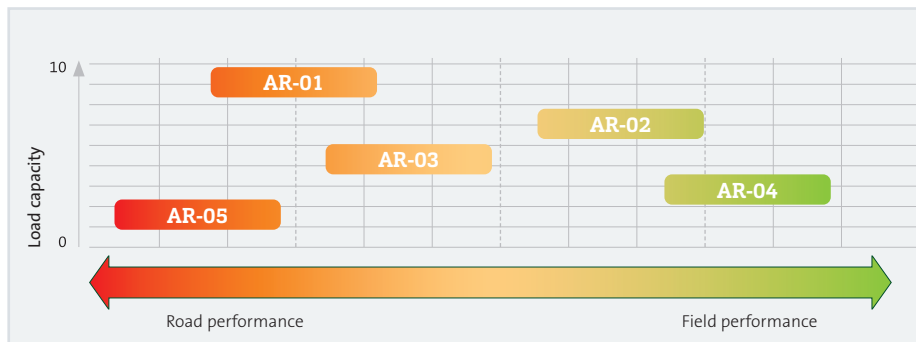

Trailer Radial Tyres



Trailer Radial Tyres

Technical data and load capacities

Tyre size	Tread pattern	Service description LI/SS	Rims * (permitted)	Section width (mm)	Overall diameter (mm)	Loaded static radius (mm)	Rolling circumference (mm)
385/65 R 22.5 (15 R 22.5)	AR-01	161 F	11.75 × 22.5	389	1 072	485	3 248
445/65 R 22.5 (18 R 22.5)	AR-01	169 F	14.00 × 22.5	454	1 150	514	3 484

Tyre size	Tread pattern	Service description LI/SS	Rims * (permitted)	Section width (mm)	Overall diameter (mm)	Loaded static radius (mm)	Rolling circumference (mm)
460/65 R 22.5 IMP	AR-01	168 A8 / 156 A8	14.00 × 22.5 (15.00 × 22.5, 16.00 × 22.5)	450	1 170	550	3 456

* Further admissible rims on request

For intensive road transport at 80/65/50/40/30 km/h the pressure must be increased by 0.4 bar. Maximum inflation pressure should never be exceeded. All load values are valid for ground slopes up to and including 20% (11°). When operating on slopes greater than 20%, please, contact the producer. Tubeless tyres – may be used with a tube.

AR-01



Tyre load capacity (kg) at tyre pressure (bar)											Speed (km/h)
4.0	4.5	5.0	5.5	6.0	6.5	7.0	7.5	8.0	8.5	9.0	
		2 600	2 800	3 000	3 200	3 400	3 600	3 850	4 100	4 625	80
		2 795	3 010	3 225	3 440	3 655	3 870	4 140	4 410	4 970	65
		2 910	3 135	3 360	3 585	3 810	4 030	4 310	4 590	5 180	50
		2 990	3 220	3 450	3 680	3 910	4 140	4 430	4 715	5 319	40
		3 250	3 500	3 750	4 000	4 250	4 500	4 815	5 125	5 781	30
		4 680	5 040	5 400	5 760	6 120	6 480	6 930	7 380	8 325	10
3 200	3 500	3 800	4 100	4 400	4 700	5 000	5 300	5 800			80
3 440	3 765	4 085	4 410	4 730	5 055	5 375	5 700	6 235			65
3 585	3 920	4 255	4 590	4 930	5 265	5 600	5 935	6 495			50
3 680	4 025	4 370	4 715	5 060	5 405	5 750	6 095	6 670			40
4 000	4 375	4 750	5 125	5 500	5 875	6 250	6 625	7 250			30
5 760	6 300	6 840	7 380	7 920	8 460	9 000	9 540	10 440			10

Tyre load capacity (kg) at tyre pressure (bar)										Speed (km/h)
0.8	1.2	1.6	2.0	2.4	2.8	3.2	3.6	4.0	5.0	
1 512	1 966	2 419	2 772	3 226	3 679	3 931	4 334	4 738	5 040	50
1 680	2 184	2 688	3 080	3 584	4 088	4 368	4 816	5 264	5 600	40
1 882	2 446	3 011	3 450	4 014	4 579	4 892	5 394	5 896	6 272	30
2 117	2 752	3 387	3 881	4 516	5 151	5 504	6 068	6 633	7 056	20
2 352	3 058	3 763	4 312	5 018	5 723	6 115	6 742	7 370	7 840	10

Trailer Radial Tyres (continued)

Technical data and load capacities

Tyre size	Tread pattern	Service description LI/SS	Rims * (permitted)	Section width (mm)	Overall diameter (mm)	Loaded static radius (mm)	Rolling circumference (mm)
440/50 R 17 IMP	AR-04 All terrain	135 D	14.00 × 17 13.00 × 17	441 431	873	393	2 605
500/50 R 17 IMP	AR-03 Universal service	149 D	16.00 × 17	502	933	425	2 800
560/60 R 22.5 IMP	AR-02	161 D	16.00 × 22.5 18.00 × 22.5	546	1 248	563	3 793

Tyre size	Tread pattern	Service description LI/SS	Rims * (permitted)	Tube Valve	Section width (mm)	Overall diameter (mm)	Loaded static radius (mm)	Rolling circumference (mm)
355/60 R 18 MPT	AR-05 AG trailer	142 J	11 × 18	(43 GS 16)** 10.5/80- /13.0/65-18; 355/60-18 T	352	890	398	2 650

* Further admissible rims on request

** Valve 50 GW optional

For intensive road transport at 100/80/65/50/40/30 km/h the pressure must be increased by 0.4 bar. Maximum inflation pressure should never be exceeded.

All load values are valid for ground slopes up to and including 20% (11°). When operating on slopes greater than 20%, please, contact the producer.

Tubeless tyres – may be used with a tube.



	Tyre load capacity (kg) at tyre pressure (bar)										Speed (km/h)	
	0.8	1.0	1.2	1.6	2.0	2.4	2.8	3.2	3.6	4.0		5.0
		870	950	1 100	1 430	1 575	1 715	2 040	2 180			65
	1 075	1 185	1 295	1 500	1 940	2 145	2 330	2 775	2 965			40
	1 190	1 315	1 435	1 665	2 155	2 380	2 585	3 080	3 290			30
	1 420	1 570	1 715	1 985	2 570	2 840	3 085	3 670	3 925			10
				1 150	1 505	1 680	1 845	2 200	2 665	–	3 250	65
				1 740	2 275	2 540	2 785	3 330	4 030	–	4 420	40
				1 930	2 530	2 825	3 090	3 695	4 470	–	4 910	30
				2 305	3 015	3 365	3 685	4 405	5 330	–	5 850	10
		2 065	2 305	2 785	3 265	3 745	3 965	4 185	4 405	4 625		65
		2 499	2 789	3 370	3 951	4 531	4 798	5 064	5 330	5 596		50
		2 808	3 135	3 788	4 440	5 093	5 392	5 692	5 991	6 290		40
		3 118	3 481	4 205	4 930	5 655	5 987	6 319	6 652	6 984		30
		3 717	4 149	5 013	5 877	6 741	7 137	7 533	7 929	8 325		10

	Tyre load capacity (kg) at tyre pressure (bar)								Speed (km/h)
	1.6	2.0	2.5	3.0	3.5	4.0	4.5	5.0	
	1 030	1 220	1 460	1 700	1 930	2 170	2 410	2 650	100
	1 120	1 320	1 580	1 840	2 090	2 350	2 610	2 880	65



HCM

LOAD CAPACITY	██████████
TRACTION	██████████
SELF-CLEANING	██████████
HANDLING ON ROAD	██████████
COST EFFICIENCY	██████████

High Capacity Municipal (HCM)

Universal quiet running tyre for all terrains and applications



Particularly suitable for municipal and road maintenance tractors and equipment. Designed for **all-season use**.



High durability due to steel belted radial construction and unique design of tread pattern in the central part.



Exceptional traction characteristics due to more edges on the lugs. Different lugs width in shoulder for better traction in deeper terrain.



Excellent self-cleaning and **very good steering characteristics**.



Low noise emission and vibration, thanks to different length of pitches and their alignment along circumference.

Pitches with the same length

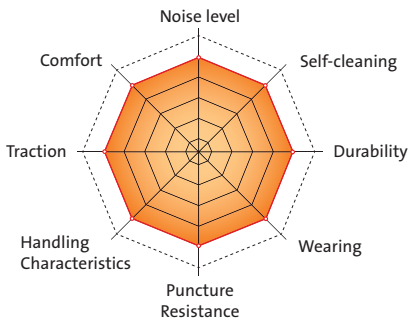

Pitches with different length

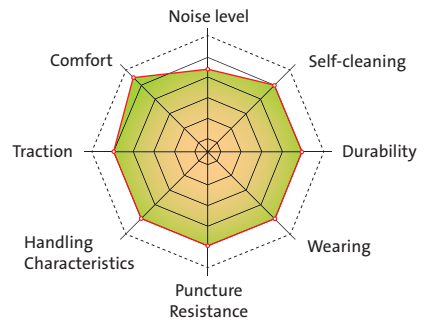

Municipal tyres – reduction of noise emission

The same length of pitches – spectrum comprises periodic lines with high amplitude (all noise concentrated into multiple repeated basic frequency – formation of disturbing noise).

Different length of pitches and their alignment gives a spectrum with low amplitude – noise is divided into whole frequency range – reduction of disturbing noise.

HCM

Technical data and load capacities

Tyre size	Service description LI/SS	Rims * (permitted)	Section width (mm)	Overall diameter (mm)	Loaded static radius (mm)	Rolling circumference (mm)	Speed radius index	
340/80 R 18 IND	138 D (143 A8)	W 11 L W 12 L W 10 L	345 355 335	999	459	3 010	475	
360/80 R 24 IND	139 D (144 A8)	W 11 L W 12 L W 13 L	360 370 380	1 185	535	3 540	575	
400/80 R 24 IND	144 D (149 A8)	DW 13 W 14 L DW 14 L	404	1 250	575	3 770	600	
440/80 R 24 IND	149 D (154 A8)	DW 14 L W 15 L DW 15 L	464	1 318	601	3 958	625	
400/80 R 28 IND	146 D (151 A8)	DW 13 W 14 L DW 14 L	410	1 354	625	4 090	650	
440/80 R 28 IND	151 D (156 A8)	DW 14 L DW 15 L DW 16 L	455	1 413	647	4 252	675	
540/65 R 30 IND	156 D (161 A8)	DW 18 L DW 16 L DW 20 B	546 526 566	1 463	675	4 417	700	
440/80 R 34 IND	155 D (159 A8)	DW 14 L DW 15 L DW 16 L W 13 L	445 455 465 435	1 565	715	4 705	750	



	Tyre load capacity (kg) at tyre pressure (bar)							Speed (km/h)
	1.2	1.6	2.0	2.4	2.8	3.2		
925	1120	1320	1500	1750	1950	2 360	65	
1 000	1210	1425	1620	1890	2 105	2 550	50	
1 060	1285	1 525	1 750	2 000	2 240	2 725	40	
1 100	1335	1 585	1 820	2 080	2 330	2 835	30	
1 155	1400	1 660	1 910	2 180	2 440	2 970	20	
1 325	1 605	1 905	2 190	2 500	2 800	3 405	10	
1 150	1400	1 650	1 900	2 180	2 430		65	
1 240	1 510	1 780	2 050	2 355	2 625		50	
1 320	1 600	1 900	2 180	2 500	2 800		40	
1 375	1 665	1 975	2 265	2 600	2 910		30	
1 440	1 745	2 070	2 375	2 725	3 050		20	
1 650	2 000	2 375	2 725	3 125	3 500		10	
1 320	1 630	1 910	2 220	2 500	2 800		65	
1 424	1 757	2 060	2 394	2 697	3 030		50	
1 528	1 885	2 210	2 568	2 893	3 250		40	
1 589	1 960	2 298	2 670	3 008	3 380		30	
1 669	2 059	2 414	2 805	3 160	3 550		20	
1 913	2 361	2 768	3 215	3 622	4 070		10	
1 530	1 890	2 210	2 570	2 900	3 250		65	
1 650	2 040	2 390	2 780	3 130	3 510		50	
1 770	2 180	2 550	2 970	3 340	3 750		40	
1 840	2 270	2 660	3 090	3 480	3 900		30	
1 930	2 380	2 790	3 240	3 650	4 090		20	
2 210	2 730	3 190	3 710	4 180	4 690		10	
1 410	1 740	2 040	2 370	2 670	3 000		65	
1 530	1 880	2 210	2 560	2 890	3 240		50	
1 630	2 010	2 350	2 730	3 080	3 450		40	
1 690	2 090	2 450	2 840	3 200	3 590		30	
1 780	2 190	2 570	2 980	3 360	3 770		20	
2 040	2 510	2 940	3 420	3 850	4 320		10	
1 630	2 010	2 350	2 730	3 080	3 450		65	
1 760	2 170	2 540	2 950	3 320	3 730		50	
1 880	2 320	2 720	3 160	3 560	4 000		40	
1 960	2 420	2 830	3 290	3 710	4 160		30	
2 050	2 530	2 970	3 450	3 890	4 360		20	
2 350	2 900	3 400	3 950	4 450	5 000		10	
1 880	2 320	2 720	3 160	3 560	4 000		65	
2 030	2 505	2 940	3 415	3 845	4 320		50	
2 175	2 685	3 145	3 655	4 115	4 625		40	
2 260	2 790	3 270	3 800	4 280	4 810		30	
2 370	2 925	3 425	3 980	4 485	5 040		20	
2 715	3 350	3 930	4 565	5 145	5 780		10	
1 900	2 300	2 650	3 075	3 450	3 875		65	
2 050	2 485	2 860	3 320	3 725	4 185		50	
2 120	2 575	3 000	3 450	3 875	4 375		40	
2 205	2 680	3 120	3 590	4 030	4 550		30	
2 310	2 805	3 270	3 760	4 225	4 770		20	
2 650	3 220	3 750	4 315	4 845	5 470		10	

HCM (continued)

Technical data and load capacities

Tyre size	Service description LI/SS	Rims * (permitted)	Section width (mm)	Overall diameter (mm)	Loaded static radius (mm)	Rolling circumference (mm)	Speed radius index
480/80 R 34 IND	159 D (164 A8)	DW 15 L DW 16 L DW 18 L	479	1 632	745	4 870	775
480/80 R 38 IND	161 D (166 A8)	DW 15 L DW 16 L DW 18 L	507	1 738	800	5 243	825
540/80 R 38 IND	167 D (172 A8)	DW 18 L DW 16 L	575	1 837	845	5 540	875
650/65 R 42 IND	171 D (176 A8)	DW 20 B DW 21 B DW 23 B	641 651 671	1 916	882	5 787	925

* Further admissible rims on request

All load values are valid for ground slopes up to and including 20% (11°). When operating on slopes greater than 20%, please, contact the producer.
Tubeless tyres – may be used with a tube.

HCM



	Tyre load capacity (kg) at tyre pressure (bar)							Speed (km/h)
	1.2	1.6	2.0	2.4	2.8	3.2		
2 060	2 540	2 980	3 460	3 900	4 375		65	
2 230	2 750	3 220	3 740	4 210	4 730		50	
2 350	2 900	3 400	3 950	4 450	5 000		40	
2 450	3 020	3 540	4 110	4 630	5 200		30	
2 570	3 170	3 710	4 310	4 860	5 450		20	
2 940	3 630	4 250	4 940	5 570	6 250		10	
2 180	2 690	3 150	3 660	4 120	4 625		65	
2 350	2 900	3 400	3 950	4 450	5 000		50	
2 500	3 080	3 610	4 190	4 720	5 300		40	
2 600	3 210	3 760	4 370	4 920	5 520		30	
2 720	3 360	3 940	4 570	5 150	5 780		20	
3 120	3 850	4 510	5 240	5 910	6 630		10	
2 570	3 170	3 710	4 310	4 860	5 450		65	
2 768	3 416	4 005	4 653	5 242	5 890		50	
2 961	3 654	4 284	4 977	5 607	6 300		40	
3 083	3 805	4 461	5 182	5 838	6 560		30	
3 229	3 985	4 672	5 427	6 114	6 870		20	
3 704	4 570	5 358	6 225	7 013	7 880		10	
2 890	3 565	4 180	4 860	5 475	6 150		65	
3 120	3 850	4 515	5 245	5 910	6 640		50	
3 335	4 120	4 830	5 610	6 320	7 100		40	
3 470	4 285	5 020	5 835	6 575	7 385		30	
3 640	4 490	5 265	6 115	6 890	7 740		20	
4 170	5 150	6 035	7 010	7 900	8 875		10	

Municipal, Agro-Industrial
and Multipurpose Tyres



Longer service life

TI-20

TRACTION	=====
SERVICE LIFE	=====
RESISTANCE	=====
SELF CLEANING	=====



Excellent traction

TI-22

TRACTION	=====
SERVICE LIFE	=====
RESISTANCE	=====
SELF CLEANING	=====

TI series – universal radial tyres

For industrial and agricultural application

TI-20

New generation of tread pattern.

Suitable for **construction, road and agricultural work.**

Priority to traction.

Designed for **muddy conditions.**

Very good resistance to damage.

TI-22

Good traction and effective self-cleaning properties.

Excellent durability.

Suitable for backhoe loaders, wheeled loaders, telescopic handlers and similar vehicles for light service.

Also suitable for agricultural application.



Agro-industrial TI

Technical data and load capacities

Tyre size	Tread pattern Type	Rims (permitted)	New		Max. in service		Loaded static radius (mm)	Rolling circumference (mm)	
			Overall diameter (mm)	Section width (mm)	Overall diameter (mm)	Section width (mm)			
340/80 R 18 IND	TI-20 TL	11×18 (12×18, W 10×18, W 11×18)	1 001	343	1 023	360	449	2 993	
460/70 R 24 IND (17.5L R 24)	TI-22 TL	DW 14 L×24 (DW 15 L, DW 16 L, 14, 16, W 14 L)	1 254	455	1 280	478	559	3 700	
480/80 R 26 IND	TI-20 TL	DW 15 L×26 (DW 16 L×26)	1 428	500	1 458	525	640	4 250	
440/70 R 28 IND	AC 70 G TL	W 13 W 14 L W 15	1 348	435 445 455			604	4 027	
440/80 R 28 IND	TI-20 TL	DW 14 L×28 (DW 15 L×28)	1 415	441	1 445	466	640	4 235	

For intensive road transport at 65/50/40/30 km/h the pressure must be increased by 0.4 bar. Maximum inflation pressure should never be exceeded. All load values are valid for ground slopes up to and including 20% (11°). When operating on slopes greater than 20%, please, contact the producer.

AC 70 G



TI-20



TI-22



	Service description LI/SS	Tyre load capacity (kg) at speed (km/h)						Tyre pressure (bar)	
		0	10	10 Cyclic	20	30	40		50
143 A8		3 760	2 045	2 450	1 780	1 700	1 635	1 570	2.0
		4 390	2 390	2 865	2 080	1 985	1 910	1 740	2.5
		5 015	2 725	3 270	2 375	2 270	2 180	1 985	3.0
		5 635	3 060	3 675	2 670	2 550	2 450	2 230	3.5
		6 265	3 405	4 090	2 970	2 835	2 725	2 480	4.0
159 A8		6 010	3 265	3 920	2 845	2 715	2 610	2 375	2.0
		7 020	3 815	4 580	3 330	3 175	3 055	2 780	2.5
		8 035	4 365	5 240	3 805	3 635	3 495	3 180	3.0
		9 050	4 920	5 900	4 290	4 090	3 935	3 580	3.5
		10 065	5 470	6 565	4 770	4 550	4 375	3 980	4.0
160 A8		7 073	3 844	4 613	3 352	3 198	3 075	2 798	2.0
		7 705	4 188	5 025	3 652	3 484	3 350	3 049	2.2
		8 165	4 438	5 325	3 870	3 692	3 550	3 231	2.4
		8 625	4 688	5 625	4 088	3 900	3 750	3 413	2.6
		9 200	5 000	6 000	4 360	4 160	4 000	3 640	2.8
		9 775	5 313	6 375	4 633	4 420	4 250	3 868	3.0
		10 350	5 625	6 750	4 905	4 680	4 500	4 095	3.2
152 A8 (152 B)		5 715	3 080	3 725	2 710	2 585	2 485	2 485	2.0
		6 125	3 300	3 995	2 900	2 770	2 665	2 665	2.2
		6 530	3 520	4 260	3 095	2 950	2 840	2 840	2.4
		6 940	3 740	4 525	3 290	3 135	3 020	3 020	2.6
		7 350	3 995	4 790	3 485	3 320	3 195	3 195	2.8
		7 755	4 220	5 060	3 675	3 505	3 370	3 370	3.0
152 A8 (152 B)		8 165	4 440	5 325	3 870	3 690	3 550	3 550	3.2
		6 440	3 500	4 200	3 052	2 912	2 800	2 548	2.0
		6 900	3 750	4 500	3 270	3 120	3 000	2 730	2.2
		7 245	3 938	4 725	3 434	3 276	3 150	2 867	2.4
		7 935	4 313	5 175	3 761	3 588	3 450	3 140	2.6
		8 395	4 563	5 475	3 979	3 796	3 650	3 322	2.8
		8 913	4 844	5 813	4 224	4 030	3 875	3 526	3.0
		9 200	5 000	6 000	4 360	4 160	4 000	3 640	3.2



AC 70 G



AC 70 G

Universal radial multipurpose tyre (MPT)



Stable, safe and comfortable running on the road, thanks to a wide tread area and large lug overlap in the tread centre.



Economical thanks to low wear.



Tyres in the MPT range have a special casing and steel belt for **high speeds up to 90 km/h**.



AC 70 G

Technical data and load capacities

Tyre size	Profil Typ	Service description LI/SS	Rims * (permitted)	Section width (mm)	Overall diameter (mm)	Loaded static radius (mm)	Rolling circumference (mm)
265/70 R 16 MPT	AC 70 G TL	114 G	8 9 7	261 271 251	775	354	2 333
285/80 R 16 MPT	AC 70 G TL	126 G	10 9	308 298	866	370	2 540
425/55 R 17 MPT	AC 70 G TL	134 G	13	428	884	399	2 642
325/70 R 18 MPT	AC 70 G TL	125 G	10 11 9	321 331 311	918	421	2 765
365/70 R 18 MPT	AC 70 G TL	132 G	11 12 10	365 375 355	978	449	2 947
275/80 R 20 MPT	AC 70 G TL	131 G	9	274	966	446	2 890
335/80 R 20 MPT	AC 70 G TL	134 G	11 10	320 310	1 048	485	3 168

AC 70 G



MPT-22



		Tyre load capacity (kg) at tyre pressure (bar)											Speed (km/h)			
		0.6	0.8	1.0	1.2	1.4	1.6	2.0	2.5	3.0	3.5	4.0		4.5	6.0	
	430 610		460 500 520 570 720	460	510	570	630	740	880	1 030	1 180				90 65 50 40 30 10	
				490	560	620	680	800	960	1 120	1 280					
				510	570	640	700	830	1 000	1 160	1 320					
				520	590	650	720	850	1 020	1 190	1 360					
				570	640	710	780	930	1 110	1 300	1 480					
820	920	1 030	1 130	1 330	1 600	1 860	2 120									
	540 770		580 630 720 900	570	650	720	790	930	1 110	1 280	1 450	(4.25 bar)			90 65 50 40 30 10	
				620	700	780	860	1 010	1 200	1 390	1 570	1 700				1 840
				640	720	800	880	1 040	1 240	1 430	1 620	1 900				
				660	740	820	910	1 070	1 270	1 470	1 670	1 950				
				720	810	900	990	1 170	1 380	1 600	1 810	2 120				
1 030	1 160	1 290	1 420	1 680	1 990	2 300	2 610	3 060								
	740 1 060		790 860 980	780	880	980	1 080	1 280	1 550	1 830	2 120				90 65 50 40 30 10	
				850	960	1 070	1 170	1 390	1 680	1 990	2 300					
				880	990	1 100	1 210	1 430	1 740	2 050	2 370					
				900	1 020	1 130	1 240	1 470	1 780	2 100	2 440					
				980	1 110	1 230	1 350	1 600	1 940	2 290	2 650					
1 410	1 590	1 770	1 940	2 300	2 790	3 290	3 820									
	620 890		660 720 760 820 940	660	740	820	900	1 060	1 260	1 460	1 650				90 65 50 40 30 10	
				710	800	890	980	1 150	1 370	1 580	1 790					
				740	830	920	1 010	1 200	1 410	1 630	1 850					
				760	850	950	1 040	1 230	1 460	1 680	1 900					
				820	930	1 030	1 130	1 340	1 570	1 820	2 060					
1 180	1 330	1 480	1 630	1 920	2 270	2 620	2 970									
	740 1 060		790 860 990	790	890	980	1 080	1 280	1 520	1 760	2 000				90 65 50 40 30 10	
				860	960	1 070	1 170	1 380	1 650	1 910	2 170					
				880	990	1 100	1 210	1 440	1 700	1 970	2 240					
				910	1 020	1 130	1 250	1 470	1 750	2 020	2 300					
				990	1 110	1 230	1 360	1 600	1 900	2 200	2 500					
1 420	1 600	1 770	1 950	2 300	2 730	3 170	3 600									
	560 810		600 660 750 840 940	600	670	750	820	970	1 160	1 340	1 510	1 690	(4.75 bar)		90 65 50 40 30 10	
				650	730	810	890	1 060	1 250	1 450	1 640	1 830	1 950			2 120
				670	760	840	920	1 090	1 290	1 500	1 690	1 890	2 180			
				690	780	860	950	1 120	1 330	1 540	1 730	1 940	2 240			
				750	840	940	1 030	1 220	1 440	1 670	1 890	2 110	2 440			
1 080	1 210	1 350	1 480	1 750	2 080	2 400	2 720	3 040	3 510							
	760 1 100		820 890 1 020 1 150 1 280	810	920	1 020	1 120	1 330	1 590	1 870	2 120				90 65 50 40 30 10	
				880	990	1 110	1 220	1 440	1 730	2 010	2 300					
				910	1 030	1 140	1 250	1 480	1 780	2 080	2 380					
				940	1 050	1 170	1 290	1 520	1 820	2 130	2 440					
				1 020	1 150	1 270	1 400	1 650	1 990	2 320	2 650					
1 460	1 650	1 830	2 010	2 380	2 870	3 340	3 820									

AC 70 G (continued)

Technical data and load capacities

Tyre size	Profil Typ	Service description LI/SS	Rims * (permitted)	Section width (mm)	Overall diameter (mm)	Loaded static radius (mm)	Rolling circumference (mm)	
375/70 R 20 MPT	AC 70 G TL	136 G	11 12 10	390 400 380	1 034	471	3 107	
405/70 R 20 MPT	AC 70 G TL	136 G	11 13	405 425	1 065	485	3 225	
425/75 R 20 MPT	AC 70 G TL	148 G	13 11	441 421	1 148	521	3 440	
445/65 R 22.5 MPT	AC 70 +	160 G	14 13	450 440	1 172	536	3 525	
405/70 R 24 MPT	AC 70 G TL	149 G	13	419	1 166	541	3 530	
445/70 R 24 MPT	AC 70 G TL	151 G	W 13 W 14 L W 12	435 445 425	1 248	561	3 708	
445/70 R 24 MPT (17.5L R 24)	MPT-22	151 G	DW 15 L	465	1 255	573	3 765	

AC 70 G



MPT-22



Tyre load capacity (kg) at tyre pressure (bar)														Speed (km/h)
0.6	0.8	1.0	1.2	1.4	1.6	2.0	2.5	3.0	3.5	4.0	4.5	6.0		
			860	970	1 080	1 180	1 400	1 630	1 850	2 050	2 240			90
			930	1 050	1 170	1 280	1 520	1 770	2 000	2 220	2 430			65
			960	1 090	1 210	1 330	1 570	1 820	2 070	2 300	2 510			50
		870	990	1 110	1 240	1 360	1 610	1 870	2 120	2 360	2 580			40
810	940	1 080	1 210	1 350	1 480	1 750	2 040	2 310	2 560	2 800				30
1 160	1 360	1 550	1 740	1 940	2 130	2 520	2 930	3 320	3 690	4 030				10
			970	1 090	1 210	1 340	1 580	1 820	2 040	2 240				90
			1 050	1 190	1 320	1 450	1 710	1 970	2 210	2 430				65
			1 090	1 220	1 360	1 500	1 770	2 040	2 280	2 510				50
	980	1 120	1 260	1 400	1 540	1 820	2 090	2 350	2 580					40
910	1 060	1 210	1 370	1 520	1 670	1 970	2 270	2 550	2 800					30
1 310	1 530	1 750	1 970	2 190	2 400	2 840	3 270	3 670	4 030					10
			1 120	1 260	1 400	1 540	1 810	2 150	2 490	2 820	3 150			90
			1 210	1 360	1 510	1 670	1 970	2 340	2 700	3 060	3 420			65
			1 250	1 410	1 560	1 720	2 030	2 410	2 790	3 160	3 530			50
	1 120	1 280	1 440	1 610	1 770	2 090	2 480	2 860	3 240	3 620				40
1 050	1 220	1 400	1 570	1 740	1 920	2 270	2 690	3 110	3 530	3 940				30
1 510	1 760	2 010	2 260	2 510	2 760	3 270	3 880	4 480	5 080	5 670				10
			1 270	1 430	1 580	1 740	2 060	2 410	2 750	3 075	3 390	3 690	4 500	90
			1 370	1 550	1 720	1 890	2 235	2 615	2 985	3 340	3 675	4 000	4 885	65
			1 420	1 600	1 770	1 950	2 305	2 700	3 080	3 445	3 795	4 130	5 040	50
	1 280	1 460	1 640	1 820	2 005	2 365	2 770	3 165	3 540	3 900	4 240	5 175	40	
1 190	1 390	1 580	1 780	1 980	2 175	2 575	3 015	3 440	3 845	4 235	4 610	5 625	30	
1 710	2 000	2 280	2 570	2 850	3 135	3 705	4 340	4 950	5 540	6 100	6 640	8 100	10	
			1 050	1 180	1 320	1 450	1 710	2 030	2 340	2 650	2 950	3 250		90
			1 140	1 290	1 430	1 570	1 860	2 200	2 540	2 870	3 200	3 530		65
			1 180	1 330	1 470	1 620	1 920	2 270	2 620	2 960	3 300	3 640		50
	1 060	1 210	1 360	1 510	1 670	1 970	2 330	2 690	3 040	3 390	3 740			40
990	1 150	1 320	1 480	1 650	1 810	2 140	2 530	2 920	3 310	3 690	4 060			30
1 420	1 660	1 900	2 130	2 370	2 610	3 080	3 650	4 210	4 760	5 310	5 850			10
			1 220	1 370	1 520	1 670	1 980	2 440	2 930	3 450				90
			1 320	1 490	1 650	1 820	2 150	2 650	3 180	3 740				65
			1 370	1 540	1 710	1 880	2 220	2 740	3 290	3 860				50
	1 230	1 400	1 580	1 750	1 930	2 280	2 810	3 370	3 970					40
1 140	1 330	1 520	1 710	1 900	2 090	2 480	3 050	3 670	4 310					30
1 650	1 920	2 190	2 470	2 740	3 020	3 560	4 400	5 280	6 210					10
			1 200	1 345	1 500	1 635	1 930	2 400	2 650	3 010	3 380	(4.25 bar)		90
			1 248	1 399	1 560	1 700	2 007	2 496	2 756	3 130	3 515	3 588		80
			1 284	1 439	1 605	1 749	2 065	2 568	2 836	3 221	3 617	3 692		70
			1 344	1 506	1 680	1 831	2 162	2 688	2 968	3 371	3 786	3 864		50
			1 380	1 547	1 725	1 880	2 220	2 760	3 050	3 470	3 880	3 970		40
			2 150	2 421	2 700	2 943	3 470	4 320	4 770	5 430	6 080	6 210		10

AC 70 G (continued)

Technical data and load capacities

Tyre size	Profil Typ	Service description LI/SS	Rims * (permitted)	Section width (mm)	Overall diameter (mm)	Loaded static radius (mm)	Rolling circumference (mm)
495/70 R 24 MPT	AC 70 G TL	155 G	W 15 L W 16 L W 14 L	493 503 483	1 313	582	3 908
495/70 R 30 MPT	AC 70 G TL	147 G	W 15 L W 16 L W 14 L	486 496 476	1 462	666	4 325

* Further admissible rims on request

Overloading of the tyres is not permitted.

After 2 hours of driving on highways ½ hour stop for cooling down of the tyres.

Load values for 0.6 bar are for calculating dual and triple load values only.

30 km/h (up to 40 km/h) load values also apply for low-speed high-torque field work.

For plowing with single driven tyres in the furrow, a minimum inflation pressure of 0.8 bar is required.

For intensive road transport at 90/65/50/40/30 km/h the pressure must be increased by 0.4 bar. Maximum inflation pressure should never be exceeded.

All load values are valid for ground slopes up to and including 20% (11°). When operating on slopes greater than 20%, please, contact the producer.

Tubeless tyres – may be used with a tube.

AC 70 G



MPT-22



		Tyre load capacity (kg) at tyre pressure (bar)											Speed (km/h)		
		0.6	0.8	1.0	1.2	1.4	1.6	2.0	2.5	3.0	3.5	4.0		4.5	6.0
				1 440	1 620	1 800	1 980	2 340	2 840	3 250	3 875				90
				1 560	1 760	1 950	2 150	2 540	3 080	3 630	4 210				65
				1 620	1 810	2 020	2 220	2 620	3 180	3 750	4 340				50
				1 660	1 860	2 070	2 280	2 690	3 260	3 850	4 460				40
1 350	1 570			1 800	2 020	2 250	2 470	2 920	3 550	4 190	4 850				30
		1 940	2 270	2 590	2 920	3 240	3 560	4 210	5 110	6 030	6 980				10
				1 590	1 790	1 990	2 180	2 580	3 075					90	
				1 720	1 940	2 160	2 370	2 800	3 340					65	
				1 780	2 000	2 220	2 450	2 890	3 450					50	
				1 830	2 060	2 280	2 510	2 970	3 540					40	
1 490	1 740			1 990	2 230	2 480	2 730	3 230	3 850					30	
		2 150	2 500	2 860	3 220	3 580	3 930	4 650	5 540					10	



Excellent traction



MPT-01

Tread pattern with very good traction and self-cleaning properties. Suitable above all for loader applications.



Excellent traction



TD-10

Lugged tread pattern for powered axle.



Excellent traction



TR-01 (R-4)

Excellent traction pattern, suitable for industrial and agricultural application.



Excellent traction



TI-05 (R-4)

Robust industrial tread pattern with excellent traction properties.



Excellent traction



TD-03 (R-1)

Pattern suitable above all for harder conditions due to optimised number of lugs.

Agro-industrial diagonal tyres

Robust and durable tyres for various work

Tyre size	MPT-01	TD-10	TR-01	TI-05	TD-03
280/80-18	•				
275/80-18 MPT		•			
340/80-18	•				
320/80-18		•			
275/80-20 MPT		•			
335/80-20 MPT		•			
340/80-20	•				
360/80-20		•			
365/80-20 MPT		•			
400/70-20		•			
405/70-20	•		•		
15.5/80-24		•	•		
400/80-24 IND				•	
405/70-24	•				
16.5/85-24		•			
17.5L-24			•		
460/70-24 IND			•	•	
19.5L-24 IND				•	
500/70-24 IND				•	
16.9-30 IND					•



Agro-industrial diagonal

Technical data and load capacities

Tyre size	Tread pattern	Type	Rims * (permitted)	Tube Flap	Section width (mm)	Overall diameter (mm)	Loaded static radius (mm)	Rolling circumference (mm)	
280/80-18 (10.5-18)	MPT-01	TL	9×18	10-18	270	905	419	2 660	
280/80-18 (10.5-18)	MPT-01	TL	9×18	10-18	270	905	419	2 660	
275/80-18 MPT (10.5-18 MPT)	TD-10	TL	9×18	–	278	911	422	2 730	
340/80-18 (12.5-18)	MPT-01	TL	11×18 (9×18)	12.5-18 12-18HS	325	990	455	2 910	
340/80-18 (12.5-18)	MPT-01	TL	11×18 (9×18)	12.5-18 12-18HS	325	990	455	2 910	
340/80-18 (12.5-18)	MPT-01	TL	11×18 (9×18)	12.5-18 12-18HS	325	990	455	2 910	
275/80-20 MPT (10.5-20 MPT)	TD-10	TL	9×20	–	278	948	444	2 805	
275/80-20 MPT (10.5-20 MPT)	TD-10	TL	9×20	–	278	948	444	2 805	
335/80-20 MPT (12.5-20 MPT)	TD-10	TL	11×20 11-20 SDC	–	340	1 044	480	3 055	
340/80-20 (12.5-20)	MPT-01	TL	11×20 (11;12-20SDC)	–	325	1 040	480	3 060	
340/80-20 (12.5-20)	MPT-01	TL	11×20 (11;12-20SDC)	–	325	1 040	480	3 060	
365/80-20 MPT	TD-10	TL	11×20 11-20 SDC	–	360	1 092	503	3 215	

MPT-01



TD-10



	Ply rating	Service description LI/SS	Tyre load capacity (kg) at speed (km/h)						Tyre pressure (bar)
			10	20	30	40	50	70	
	10 PR	130 B	2 368	1 835	1 687	1 628	1 480		2.25
			2 464	1 910	1 756	1 694	1 540		2.50
			2 576	1 996	1 835	1 771	1 610		2.75
			2 720	2 108	1 938	1 870	1 700		3.00
			2 848	2 207	2 029	1 958	1 780		3.25
			2 952	2 288	2 103	2 030	1 845		3.50
			3 040	2 356	2 166	2 090	1 900		3.75
	16 PR	140 B	3 280	2 540	2 330	2 250	2 050		4.50
			3 520	2 720	2 500	2 420	2 200		5.00
			3 760	2 910	2 670	2 580	2 350		5.50
			4 000	3 100	2 850	2 750	2 500		6.00
	10 PR	126 E	1 550	1 205	1 075	990	965		1.50
			1 910	1 485	1 325	1 220	1 185	1 060	2.00
			2 900	2 255	2 015	1 850	1 805	1 610	3.50
			3 060	2 380	2 125	1 955	1 905	1 700	3.75
	10 PR	132 B	2 416	1 872	1 721	1 661	1 510		1.75
			2 608	2 021	1 858	1 793	1 630		2.00
			2 784	2 158	1 984	1 914	1 740		2.25
			2 976	2 306	2 120	2 046	1 860		2.50
			3 104	2 406	2 212	2 134	1 940		2.75
			3 248	2 517	2 314	2 233	2 030		3.00
	12 PR	135 B	3 368	2 610	2 400	2 316	2 105		3.25
			3 488	2 703	2 485	2 398	2 180		3.50
	16 PR	145 B	3 875	3 000	2 760	2 660	2 420		4.00
			4 255	3 300	3 030	2 925	2 660		4.50
			4 640	3 595	3 300	3 190	2 900		5.00
	8 PR	123 E	1 910	1 590	1 325	1 220	1 185	1 060	1.75
			2 105	1 755	1 465	1 345	1 310	1 170	2.00
			2 520	2 100	1 750	1 610	1 570	1 400	2.50
			2 790	2 325	1 940	1 785	1 735	1 550	3.00
	12 PR	131 E	3 095	2 580	2 150	1 980	1 925	1 720	3.50
			3 375	2 810	2 345	2 155	2 100	1 875	4.00
			3 510	2 925	2 440	2 245	2 185	1 950	4.25
	10 PR	129 E	2 465	2 055	1 710	1 575	1 535	1 370	1.75
			2 720	2 265	1 890	1 735	1 690	1 510	2.00
			3 060	2 550	2 125	1 955	1 905	1 700	2.50
			3 330	2 775	2 310	2 130	2 070	1 850	3.00
	10 PR	133 B	3 216	2 492	2 291	2 211	2 010		2.75
			3 344	2 592	2 383	2 299	2 090		3.00
	12 PR	136 B	3 488	2 703	2 485	2 398	2 180		3.25
			3 616	2 802	2 576	2 486	2 260		3.50
	10 PR	132 E	2 810	2 340	1 950	1 795	1 750	1 560	1.75
			3 115	2 595	2 160	1 990	1 940	1 730	2.00
			3 600	3 000	2 500	2 300	2 240	2 000	2.50

Agro-industrial diagonal (continued)

Technical data and load capacities

Tyre size	Tread pattern	Type	Rims * (permitted)	Tube Flap	Section width (mm)	Overall diameter (mm)	Loaded static radius (mm)	Rolling circumference (mm)
400/70 - 20	TR-01	TL	13SDC × 20	–	404	1 090	490	3 210
405/70 - 20 (16/70 - 20)	MPT-01	TL	13 × 20 (13-20SDC)		407	1 076	495	3 165
405/70 - 20 (16/70 - 20)	MPT-01	TL	13 × 20 (13-20SDC)		407	1 076	495	3 165
15.5/80 - 24	TR-01	TL	W12 × 24 (W13 × 24) (W14L × 24)	–	394	1 269	585	3 730
15.5/80 - 24	TR-01	TL	W12 × 24 (W13 × 24, W14L × 24)	–	394	1 269	585	3 730
15.5/80 - 24	TR-01	TL	W12 × 24 (W13 × 24) (W14L × 24)	–	394	1 269	585	3 730
405/70 - 24 (16/70 - 24)	MPT-01	TL	13 × 24 (13-24SDC)	16/70-24	407	1 178	545	3 465
17.5L - 24	TR-01	TL	W15L × 24	–	445	1 241	580	3 650

⁰⁾ Reinforced version also available (REINFORCED)

For Non-standard version, please contact a producer.

These tyres are for normal agricultural use and not for continuous highway service.

MPT-01



TD-10



TR-01



	Ply rating	Service description LI/SS	Tyre load capacity (kg) at speed (km/h)						Tyre pressure (bar)
			10	20	30	40	50	70	
4 PR	150 B		3 040	3 735	2 420	2 175	1 975		2.00
			3 580	3 225	2 850	2 560	2 325		2.50
			4 120	3 710	3 280	2 945	2 675		3.00
			4 660	4 195	3 710	3 330	3 025		3.50
			5 160	4 645	4 100	3 685	3 350		4.00
14 PR	149 B		3 840	2 976	2 736	2 640	2 400		2.25
			4 120	3 193	2 936	2 833	2 575		2.50
			4 656	3 608	3 317	3 201	2 910		3.00
			4 928	3 819	3 511	3 388	3 080		3.25
			5 200	4 030	3 705	3 575	3 250		3.50
16 PR	152 B		5 440	4 216	3 876	3 740	3 400		3.75
			5 680	4 402	4 047	3 905	3 550		4.00
12 PR	154/142 A8		3 025	2 720	2 400	2 160	1 945		2.00
			3 185	2 865	2 525	2 275	2 050		2.25
			3 305	2 975	2 650	2 360	2 125		2.50
			3 500	3 150	2 775	2 500	2 250		2.75
			3 710	3 340	2 900	2 650	2 385		3.00
14 PR ⁽¹⁾	156/144 A8		3 815	3 435	3 025	2 725	2 455		3.25
			3 920	3 530	3 150	2 800	2 520		3.50
16 PR	159/147 A8		4 115	3 700	3 290	2 938	2 645		3.75
			4 305	3 875	3 445	3 075	2 770		4.10
14 PR	163/151 A8		4 480	4 030	3 585	3 200	2 880		4.25
			4 655	4 190	3 725	3 325	2 995		4.50
			4 830	4 345	3 865	3 450	3 105		4.75
14 PR	152 B		5 360	4 154	3 819	3 685	3 350		3.75
			5 680	4 402	4 047	3 905	3 550		4.00
10 PR	- /144 A8		2 500	2 250	2 000	1 785	1 605		1.10
			2 800	2 520	2 240	2 000	1 800		1.30
			3 100	2 790	2 480	2 215	1 995		1.50
			3 400	3 060	2 720	2 430	2 185		1.70
			3 705	3 335	2 960	2 645	2 380		2.00
			3 920	3 530	3 135	2 800	2 520		2.20

Agro-industrial diagonal (continued)

Technical data and load capacities

Tyre size	Tread pattern Type	Rims (permitted)	New		Max. in service		Loaded static radius (mm)	Rolling circumference (mm)	
			Overall diameter (mm)	Section width (mm)	Overall diameter (mm)	Section width (mm)			
400/80 - 24 IND (15.5/80 - 24)	TI-05 TL	DW 13 × 24 (DW 14 L × 24) (13 × 24, 14 × 24) (TW 14 L × 24)	1 250	404	1 294	436	573	3 688	
460/70 - 24 IND (17.5L - 24)	TI-05 TL	DW 14 L × 24 (DW 15 L, DW 16 L, 14, 16, TW 14 L)	1 250	455	1 300	494	580	3 660	
460/70 - 24 IND (17.5L - 24)	TR-01 TL	DW 14 L × 24 (DW 15 L, DW 16 L, 14, 16, TW 14 L)	1 254	455	1 300	494	565	3 700	
19.5 L - 24 IND	TI-05 TL	DW 16 L × 24	1 314	495	1 356	535	610	3 865	
500/70 - 24 IND (19.5L - 24)	TI-05 TL	DW 16 L × 24 (DW 15 L × 24) (W 15 L × 24) (W 16 L × 24)(16 × 24)	1 310	503	1 360	528	589	3 865	
16.9 - 30 IND	TD-03 TL	W 15 L × 30 (W 14 L × 30)	1 485	429	1 530	463	695	4 380	



	Service description LI/SS	Ply rating	Tyre load capacity (kg) at speed (km/h)							Tyre pressure (bar)
			Static	10	10 cyclic	20	30	40	50	
			5 975	3 245	3 895	2 830	2 700	2 595	2 365	2.00
			6 800	3 695	4 435	3 220	3 075	2 956	2 690	2.50
			7 625	4 145	4 975	3 615	3 450	3 315	3 020	3.00
			8 450	4 590	5 510	4 005	3 820	3 675	3 340	3.50
			9 275	5 040	6 050	4 395	4 195	4 030	3 670	4.00
			10 100	5 490	6 585	4 785	4 565	4 390	3 995	4.50
	162 A8	–	10 925	5 940	7 125	5 180	4 940	4 750	4 325	5.00
			6 555	3 565	4 275	3 105	2 965	2 850	2 595	2.00
			7 430	4 040	4 845	3 520	3 360	3 230	2 940	2.50
			8 305	4 515	5 415	3 935	3 755	3 610	3 285	3.00
			9 175	4 990	5 985	4 350	4 150	3 990	3 630	3.50
	159 A8	–	10 065	5 470	6 565	4 770	4 550	4 375	3 980	4.00
			6 555	3 565	4 275	3 105	2 965	2 850	2 595	2.00
			7 430	4 040	4 845	3 520	3 360	3 230	2 940	2.50
			8 305	4 515	5 415	3 935	3 755	3 610	3 285	3.00
			9 175	4 990	5 985	4 350	4 150	3 990	3 630	3.50
	159 A8	–	10 065	5 470	6 565	4 770	4 550	4 375	3 980	4.00
			4 510	2 450	2 940	2 140	2 040	1 960	1 785	1.10
			5 095	2 770	3 325	2 415	2 305	2 215	2 015	1.30
			5 680	3 090	3 705	2 690	2 570	2 470	2 250	1.50
			6 270	3 405	4 090	2 970	2 835	2 725	2 480	1.70
			7 075	3 845	4 615	3 350	3 200	3 075	2 800	1.90
			7 510	4 080	4 900	3 560	3 395	3 265	2 970	2.10
	151 A8	12 PR	7 935	4 315	5 175	3 760	3 590	3 450	3 140	2.30
			7 705	4 185	5 022	3 650	3 485	3 350	3 050	2.00
			8 650	4 700	5 640	4 100	3 910	3 760	3 425	2.50
			9 600	5 220	6 260	4 550	4 340	4 175	3 800	3.00
			10 550	5 735	6 880	5 000	4 770	4 585	4 175	3.50
	164 A8	–	11 500	6 250	7 500	5 450	5 200	5 000	4 550	4.00
			4 740	2 575	3 090	2 245	2 140	2 060	1 870	1.10
			5 245	2 850	3 420	2 485	2 370	2 280	2 070	1.30
			5 750	3 125	3 750	2 725	2 600	2 500	2 275	1.50
			6 325	3 435	4 125	2 995	2 860	2 750	2 500	1.70
			7 095	3 855	4 625	3 360	3 205	3 085	2 805	2.00
			7 475	4 060	4 875	3 540	3 380	3 250	2 955	2.20
			7 995	4 340	5 210	3 785	3 610	3 475	3 160	2.50
			8 315	4 515	5 420	3 940	3 755	3 615	3 285	2.70
	154 A8	14 PR	8 625	4 685	5 625	4 085	3 900	3 750	3 410	2.90

Agro-industrial diagonal (TD-10)

Technical data and load capacities

Tyre size	Tread pattern	Tube Flap	Rim * (permitted)	Section width (mm)	Overall diameter (mm)	Loaded static radius (mm)	Rolling circumference (mm)
320/80 - 18 (repl. 12.5/80 - 18)	TD-10 TL	12.5/14.5/80 - 18 T 38G16 S	9 × 18	308	1 000	443 ⊕ 430 ⊕+	3 025 ⊕ 3 015 ⊕+
360/80 - 20 (repl. 14.5/75 - 20)	TD-10 TL	16/70 - 20; 335/80 - 20; 375/405/70 - 20 47GW S	11 × 20 12 × 20	360 370	1 092	492 ⊕ 485 ⊕+	3 205 ⊕ 3 200 ⊕+
400/70 - 20 (repl. 16/70 - 20)	TD-10 TL	16/70 - 20; 335/80 - 20; 375/405/70 - 20 47GW S	13 × 20 14 × 20	412 422	1 106	503 ⊕ 493 ⊕+	3 337 ⊕ 3 325 ⊕+
15.5/80 - 24	TD-10 TL	14.9/16.9(13/14) - 24 T 47GW S	W 13 W 14 W 12	376 387 365	1 270	586 ⊕ 575 ⊕+	3 841 ⊕ 3 820 ⊕+
16.5/85 - 24	TD-10 TL	14.9/16.9(13/14) - 24 T 47GW S	W 13 W 15 L W 14 L	413 435 424	1 338	590 ⊕ 580 ⊕+	4 032 ⊕ 4 010 ⊕+

For Non-standard version, please contact a producer.

These tyres are for normal agricultural use and not for continuous highway service.

- ⊕ – drive wheel
⊕+ – free rolling wheel



	Service description		Tyre load capacity (kg) at tyre pressure (bar)									Speed (km/h)
	PR	LI/SS	1.0	1.5	1.8	2.0	2.3	2.5	2.8	3.1	3.4	
10 PR	126 A8 ⊕	900	1 185	1 330	1 440	1 500	1 540	1 570	1 700			40
	139 A8 ⊕→	1 290	1 700	1 900	2 060	2 145	2 200	2 315	2 430			40
8 PR	128 A8 ⊕	1 140	1 480	1 600	1 630	1 800						40
	141 A8 ⊕→	1 630	2 135	2 290	2 330	2 575						40
14 PR	142 A8 ⊕	1 190	1 565	1 750	1 890	2 110	2 260	2 455	2 650			40
	154 A8 ⊕→	1 700	2 235	2 500	2 710	3 020	3 230	3 490	3 750			40
16 PR	152 A6 ⊕	1 290	1 690	1 930	2 100	2 340	2 500	2 700	2 900	3 160	3 550	30
	164 A6 ⊕→	1 830	2 405	2 750	2 980	3 320	3 550	3 840	4 125	4 350	4 875	30
14 PR	153 A6 ⊕	1 700	2 225	2 540	2 650	2 800	2 900	3 135	3 370	3 650		30
	165 A6 ⊕→	2 400	3 150	3 600	3 750	3 955	4 090	4 420	4 750	5 150		30



AF-01

RESISTANCE	=====
TRACTION	=====
SELF-CLEANING	=====



TL-01

RESISTANCE	=====
TRACTION	=====
SELF-CLEANING	=====

AF-01 and TL-01

Heavy-duty agroforestry tractor tyres for the toughest conditions

High resistance to puncture due to reinforced construction and durable tread compound.

Great traction due to specially developed tread pattern.

Very good self-cleaning properties for better grip and less slip.

High load capability and transport properties.

Suitable for a wide range of uses in forestry and for heavy agricultural work.

Puncture resistance comparison

Thanks to reinforced construction, the radial force needed to puncture the AF-01 tyre is 35 % higher than in the case of the standard tractor drive tyre Mitas TD-19.

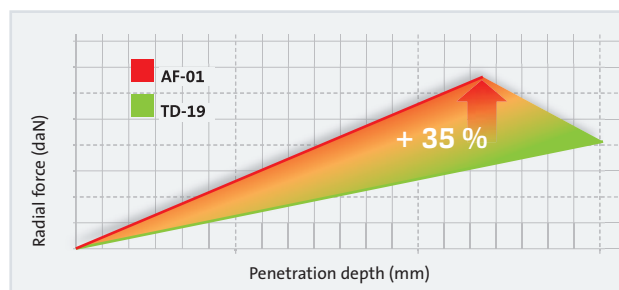

Radial force needed to puncture AF-01 and TD-19

Compared tyres:
Mitas 460/85 - 34 (18.4 - 34)
AF-01 and Mitas
18.4 - 34 TD-19



Agro Forestry Tyres AF-01, TL-01

Technical data and load capacities

Tyre size	Service description L/SS	Tread pattern	Rims * (permitted)	Tube	Section width (mm)	Overall diameter (mm)	Loaded static radius (mm)	Rolling circumference (mm)	Speed radius index	Water 75% (l)
380/85 - 24 (14.9 - 24)	137 A8 (134 B)	AF-01 TT	W 13 W 11 W 12	14.9 - 24	377 357 367	1 244	565	3 748	600	150
380/85 - 28 (14.9 - 28)	139 A8 (136 B)	AF-01 TT	W 13 W 11 W 12	14.9 - 28	386 366 376	1 354	612	4 056	650	190
16.9 - 30	12 PR	TL-01 TT	W 15 L W 14 L	16.9 - 30	429	1 485	685	4 390	700	240
420/85 - 34 (16.9 - 34)	147 A8 (144 B)	AF-01 TT	W 13 W 14 L W 15 L	16.9 - 34	425 435 445	1 582	719	4 730	750	265
460/85 - 34 (18.4 - 34)	152 A8 (149 B)	AF-01 TT	W 15 L W 14 L W 16 L	18.4 - 34	443 433 453	1 643	749	4 930	775	350

* Further admissible rims on request

For intensive road transport at 80/65/50/40/30 km/h the pressure must be increased by 0.4 bar. Maximum inflation pressure should never be exceeded. All load values are valid for ground slopes up to and including 20% (11°). When operating on slopes greater than 20%, please, contact the producer.

AF-01



TL-01



	Tyre load capacity (kg) at tyre pressure (bar)							Speed (km/h)
	1.0	1.2	1.3	1.8	2.0	2.4	2.8	
1 285	1 450	1 750	1 850	1 945	2 120			50
1 425	1 600	1 950	2 050	2 140	2 300			40
1 525	1 710	2 085	2 195	2 290	2 460			30
1 875	2 085	2 505	2 715	2 925	3 170		3 370	10
1 385	1 550	1 900	2 005	2 095	2 240			50
1 510	1 700	2 060	2 170	2 270	2 430			40
1 615	1 820	2 205	2 325	2 430	2 600			30
1 980	2 210	2 655	2 875	3 000	3 360		3 585	10
1 310	1 525	1 850	1 960	2 070	2 180			40
1 635	1 905	2 315	2 450	2 585	2 725			30
1 960	2 290	2 780	2 940	3 105	3 270			20
2 290	2 670	3 240	3 430	3 625	3 815		4 060	10
1 775	2 000	2 430	2 550	2 650	2 800			50
1 940	2 180	2 650	2 785	2 900	3 075			40
2 075	2 335	2 835	2 980	3 100	3 290			30
2 550	2 840	3 410	3 695	3 975	4 300		4 555	10
2 020	2 300	2 800	2 940	3 060	3 250			50
2 225	2 500	3 075	3 225	3 355	3 550			40
2 380	2 675	3 290	3 450	3 590	3 800			30
2 925	3 255	3 925	4 265	4 615	4 980		5 270	10



TD-01

Durable traction pattern, also suitable for industrial use.



TD-02

Universal tread pattern with excellent traction for a wide range of applications.



TD-05

Unique tread pattern with 23 degree inclined blocks for better traction and self-cleaning properties. The reinforced shoulder prevents side-slipping and helps overall tyre strength.



TD-13

A classic design for tractors, well-tested and proven.



TD-17

Pattern featuring increased tread lug depth giving better traction and less slip in difficult conditions.



TD-19

Traction tread pattern with larger rib surface in the central part.

TD series – tractor drive diagonal tyres

For tractors and other self-propelled
agricultural machinery



TD series

Technical data and load capacities

Tyre size	Tread pattern	Type	Rim (permitted)	Tube	Section width (mm)	Overall diameter (mm)	Loaded static radius (mm)	Rolling circumference (mm)	
8.3-20	TD-13	TT	W7 (W6)	8.3-20	211	895	416	2 640	
8.3-24	TD-02	TT	W7 (W6)	8.3-24/9.5-24	211	995	470	2 935	
9.5-24	TD-02	TT	W8 (W7)	8.3-24/9.5-24	241	1 050	495	3 095	
11.2-24	TD-10	TL	W10 (W9)	(11.2-24)	284	1 105	520	3 300	
11.2-24	TD-02	TT	W10 (W9)	11.2-24	284	1 105	520	3 300	
11.2-24	TD-19	TT/TL	W10 (W9)	11.2-24	284	1 105	520	3 300	
11.2-24	TD-19	TL	W10 (W9)	(11.2-24)	284	1 105	520	3 300	
12.4-24	TD-02	TT	W11 (W9, W10)	12.4-24	315	1 160	539	3 473	
12.4-24	TD-19	TT/TL	W11 (W9, W10)	12.4-24	315	1 160	539	3 473	
12.4-24	TD-19	TL	W11 (W9, W10)	(12.4-24)	315	1 160	539	3 473	
13.6-24	TD-19	TT/TL	W11 (W12)	13.6-24	335	1 210	555	3 580	
14.9-24	TD-02	TT	W13 (W11, W12)	14.9-24	378	1 265	581	3 795	



	Ply rating PR	Service description LI/SS	Tyre load capacity (kg) at speed (km/h)				Tyre pressure (bar)
			10	20	30	40	
	6 PR	104 / 92 A8	530	465	410	370	0.8
			660	580	510	460	1.2
			785	695	610	550	1.6
			915	810	710	630	2.0
	6 PR	100 A6 (93 A8)	855	730	610	490	1.5
			940	800	670	540	1.8
			1 030	880	735	590	2.1
			1 120	960	800	650	2.4
	8 PR	112 A6 (104 A8)	1 220	1 045	870	700	1.8
			1 330	1 140	950	760	2.1
			1 465	1 255	1 045	840	2.5
			1 570	1 345	1 120	900	2.8
	6 PR	102 A8 (110 A6)	940	795	670	540	1.0
			1 330	1 140	950	760	1.5
			1 485	1 270	1 060	850	1.8
	8 PR	116 A6 (108 A8)	1 330	1 140	950	760	1.5
			1 485	1 270	1 060	850	1.8
			1 620	1 385	1 155	925	2.1
			1 750	1 500	1 250	1 000	2.4
	8 PR	116 A6 (108 A8)	1 330	1 140	950	760	1.5
			1 485	1 270	1 060	850	1.8
			1 620	1 385	1 155	925	2.1
			1 750	1 500	1 250	1 000	2.4
	10 PR	119 A8	1 970	1 450	1 400	1 310	2.8
			2 040	1 510	1 460	1 360	3.0
	8 PR	120 A6 (112 A8)	1 580	1 355	1 130	905	1.5
			1 700	1 460	1 215	970	1.7
			1 835	1 570	1 310	1 050	2.0
			1 960	1 680	1 400	1 120	2.3
	8 PR	120 A6 (112 A8)	1 580	1 355	1 130	905	1.5
			1 700	1 460	1 215	970	1.7
			1 835	1 570	1 310	1 050	2.0
			1 960	1 680	1 400	1 120	2.3
	12 PR	128 A8	2 420	1 790	1 720	1 610	2.9
			2 520	1 860	1 800	1 680	3.1
			2 610	1 930	1 860	1 740	3.3
			2 700	2 000	1 930	1 800	3.5
	8 PR	123 A6 (116 A8)	1 975	1 695	1 410	1 130	1.4
			2 085	1 790	1 490	1 190	1.7
			2 170	1 860	1 550	1 250	2.0
	8 PR	128 A6 (121 A8)	2 345	2 010	1 675	1 340	1.6
			2 520	2 160	1 800	1 450	1.8

TD series (continued)

Technical data and load capacities

Tyre size	Tread pattern	Type	Rim (permitted)	Tube	Section width (mm)	Overall diameter (mm)	Loaded static radius (mm)	Rolling circumference (mm)	
14.9-24	TD-19	TT/TL	W13 (W11, W12)	14.9-24	378	1 265	581	3 795	
16.9-24	TD-02	TT	W15L (W14L)	16.9-24	429	1 335	620	3 940	
16.9-24	TD-13	TT/TL	W15L (W14L)	16.9-24	429	1 335	620	3 940	
18.4-26	TD-19	TL	W16L (W15L)	(18.4-26)	467	1 450	663	4 285	
23.1-26	TD-01	TL	DW20	(23.1-26)	587	1 605	760	4 720	
11.2-28	TD-02	TT	W10 (W9)	11.2-28	284	1 205	565	3 555	
11.2-28	TD-02	TT	W10 (W9)	11.2-28	284	1 205	565	3 555	
12.4-28	TD-02	TT	W11 (W10)	12.4-28	315	1 260	598	3 750	
12.4-28	TD-19	TT	W11 (W10)	12.4-28	315	1 260	598	3 750	
12.4-28	TD-19	TT	W11 (W10)	12.4-28	315	1 260	598	3 750	
13.6-28	TD-19	TT	W12 (W11)	13.6-28	345	1 310	612	3 853	



	Ply rating PR	Service description LI/SS	Tyre load capacity (kg) at speed (km/h)				Tyre pressure (bar)
			10	20	30	40	
8 PR	128 A6 (121 A8)	1 990	1 705	1 420	1 135	1.2	
		2 170	1 860	1 550	1 250	1.4	
		2 345	2 010	1 675	1 340	1.6	
		2 520	2 160	1 800	1 450	1.8	
8 PR	133 A6 (125 A8)	2 240	1 920	1 600	1 280	1.1	
		2 450	2 100	1 750	1 400	1.3	
		2 665	2 285	1 905	1 525	1.5	
		2 885	2 470	2 060	1 650	1.7	
8 PR	133 A6 (125 A8)	2 240	1 920	1 600	1 280	1.1	
		2 450	2 100	1 750	1 400	1.3	
		2 665	2 285	1 905	1 525	1.5	
		2 885	2 470	2 060	1 650	1.7	
12 PR	156 A8	4 785	3 470	3 380	3 190	1.9	
		5 430	3 940	3 830	3 620	2.2	
		6 000	4 360	4 160	4 000	2.5	
14 PR	156 A8	4 350	3 565	3 100	2 900	1.1	
		4 875	4 000	3 480	3 250	1.4	
		5 475	4 490	3 905	3 650	1.7	
		6 000	4 920	4 280	4 000	2.0	
6 PR	112 A6 (104 A8)	1 260	1 080	900	720	1.3	
		1 415	1 210	1 010	810	1.5	
		1 570	1 345	1 120	900	1.8	
8 PR	118 A6 (110 A8)	1 710	1 465	1 220	975	2.1	
		1 850	1 585	1 320	1 060	2.4	
8 PR	123 A6 (116 A8)	1 445	1 235	1 030	825	1.1	
		1 620	1 385	1 155	925	1.4	
		1 800	1 540	1 285	1 030	1.7	
		2 005	1 715	1 430	1 145	2.0	
		2 170	1 860	1 550	1 250	2.3	
6 PR	117 A6 (109 A8)	1 445	1 235	1 030	825	1.1	
		1 620	1 385	1 155	925	1.4	
		1 800	1 540	1 285	1 030	1.7	
10 PR	128 A6 (121 A8)	2 005	1 715	1 430	1 145	2.0	
		2 170	1 860	1 550	1 250	2.3	
		2 335	2 000	1 650	1 335	2.5	
		2 535	2 175	1 790	1 450	2.8	
6 PR	121 A6 (113 A8)	1 570	1 345	1 120	895	1.0	
		1 720	1 475	1 230	985	1.2	
		1 875	1 610	1 340	1 070	1.4	
		2 030	1 740	1 450	1 150	1.6	

TD series (continued)

Technical data and load capacities

Tyre size	Tread pattern	Type	Rim (permitted)	Tube	Section width (mm)	Overall diameter (mm)	Loaded static radius (mm)	Rolling circumference (mm)	
14.9-28	TD-19	TT	W13 (W12)	14.9-28	378	1 365	627	4 113	
16.9-28	TD-02	TT	W15L (W14L)	16.9-28	429	1 435	670	4 235	
16.9-28	TD-13	TT	W15L (W14L)	16.9-28	429	1 435	670	4 235	
16.9-28	TD-13	TT	W15L (W14L)	16.9-28	429	1 435	670	4 235	
16.9-28	TD-13	TT	W15L (W14L)	16.9-28	429	1 435	670	4 235	
16.9-30	TD-13	TT/TL	W15L (W14L)	16.9-30	429	1 485	685	4 390	
16.9-30	TD-13	TT	W15L (W14L)	16.9-30	429	1 485	685	4 390	
16.9-30	TD-13	TT	W15L (W14L)	16.9-30	429	1 485	685	4 390	
16.9-30	TD-17	TT	W15L (W14L)	16.9-30	429	1 485	685	4 390	
16.9-30	TD-17	TT	W15L (W14L)	16.9-30	429	1 485	685	4 390	
18.4-30	TD-13	TT/TL	W16L (W15L)	16.9-30	467	1 550	714	4 540	
18.4-30	TD-13	TT	W16L (W15L)	16.9-30	467	1 550	714	4 540	
18.4-30	TD-13	TT	W16L (W15L)	16.9-30	467	1 550	714	4 540	
9.5-32	TD-13	TT	W8 (W7)	9.5-32	241	1 250	597	3 695	
12.4-32	TD-13	TT	W11 (W9, W10)	12.4-32	315	1 360	633	3 975	
16.9-34	TD-02	TT	W15L (W14L)	16.9-34	429	1 585	724	4 680	
16.9-34	TD-02	TT	W15L (W14L)	16.9-34	429	1 585	724	4 680	



	Ply rating PR	Service description LI/SS	Tyre load capacity (kg) at speed (km/h)				Tyre pressure (bar)
			10	20	30	40	
8 PR	130 A6 (122 A8)	1 905	1 630	1 360	1 090	1.0	
		2 115	1 810	1 510	1 210	1.2	
		2 395	2 050	1 710	1 370	1.5	
		2 660	2 280	1 900	1 500	1.8	
10 PR	139 A6 (131 A8)	3 305	2 830	2 360	1 890	1.9	
		3 400	2 915	2 430	1 950	2.0	
8 PR	135 A6 (127 A8)	2 355	2 015	1 680	1 345	1.1	
		2 730	2 340	1 950	1 560	1.4	
		3 055	2 615	2 180	1 750	1.7	
10 PR	139 A6 (131 A8)	3 305	2 830	2 360	1 890	1.9	
		3 400	2 915	2 430	1 950	2.0	
12 PR	143 A6 (135 A8)	3 605	3 090	2 575	2 060	2.2	
		3 815	3 310	2 725	2 180	2.4	
8 PR	137 A6 (129 A8)	2 410	2 065	1 720	1 375	1.1	
		2 885	2 470	2 060	1 650	1.4	
		3 220	2 760	2 300	1 850	1.7	
10 PR	140 A6 (132 A8)	3 500	3 000	2 500	2 000	2.0	
		3 815	3 270	2 725	2 180	2.3	
8 PR	137 A6 (129 A8)	2 410	2 065	1 720	1 375	1.1	
		2 885	2 470	2 060	1 650	1.4	
		3 220	2 760	2 300	1 850	1.7	
10 PR	140 A6 (132 A8)	3 500	3 000	2 500	2 000	2.0	
		8 PR	139 A6 (131 A8)	2 645	2 270	1 890	1 515
3 110	2 665			2 220	1 775	1.2	
3 400	2 915			2 430	1 950	1.4	
12 PR	149 A6 (141 A8)	4 355	3 730	3 110	2 490	2.1	
		4 550	3 900	3 250	2 575	2.3	
14 PR	152 A6 (144 A8)	4 745	4 070	3 390	2 710	2.5	
		4 970	4 260	3 550	2 800	2.7	
6 PR	110 A6 (102 A8)	1 190	1 020	850	680	1.5	
		1 290	1 100	920	740	1.7	
		1 390	1 190	990	790	1.9	
		1 480	1 270	1 060	850	2.1	
6 PR	119 A6 (111 A8)	1 490	1 275	1 065	850	1.1	
		1 625	1 390	1 160	930	1.3	
		1 755	1 505	1 255	1 005	1.5	
		1 905	1 630	1 360	1 090	1.7	
8 PR	139 A6 (131 A8)	2 620	2 245	1 870	1 495	1.1	
		3 010	2 580	2 150	1 720	1.4	
		3 400	2 915	2 430	1 950	1.7	
10 PR	142 A6 (134 A8)	3 710	3 180	2 650	2 120	2.0	

TD series (continued)

Technical data and load capacities

Tyre size	Tread pattern	Type	Rim (permitted)	Tube	Section width (mm)	Overall diameter (mm)	Loaded static radius (mm)	Rolling circumference (mm)	
16.9-34	TD-17	TT	W15L (W14L)	16.9-34	429	1 585	724	4 680	
18.4-34	TD-02	TT	W16L (W15L)	16.9-34 18.4-34	467	1 650	770	4 865	
18.4-34	TD-19	TT/TL	W16L (W15L)	16.9-34 18.4-34	467	1 650	770	4 865	
18.4-34	TD-19	TT	W16L (W15L)	16.9-34 18.4-34	467	1 650	770	4 865	
12.4-36	TD-13	TT	W11 (W10)	12.4-36	315	1 465	685	4 330	
12.4-36	TD-13	TT	W11 (W10)	12.4-36	315	1 465	685	4 330	
13.6-36	TD-13	TT	W12 (W11)	13.6-36	345	1 515	698	4 447	
11.2-38	TD-13	TT	W10 (W9)	11.2-38	290	1 454	665	4 380	
12.4-38	TD-17	TT	W11 (W10)	12.4-38	320	1 515	719	4 514	
13.6-38	TD-02	TT	W12 (W11)	13.6-38	345	1 565	740	4 615	
13.6-38	TD-13	TT	W12 (W11)	13.6-38	345	1 565	740	4 670	



	Ply rating PR	Service description LI/SS	Tyre load capacity (kg) at speed (km/h)				Tyre pressure (bar)
			10	20	30	40	
8 PR	139 A6 (131 A8)	2 620	2 245	1 870	1 495	1.1	
		3 010	2 580	2 150	1 720	1.4	
		3 400	2 915	2 430	1 950	1.7	
12 PR	151 A6 (144 A8)	3 050	2 615	2 180	1 745	1.0	
		3 380	2 900	2 415	1 930	1.2	
		3 710	3 180	2 650	2 120	1.4	
		3 955	3 390	2 825	2 260	1.6	
		4 200	3 600	3 000	2 430	1.8	
		4 580	3 925	3 270	2 620	2.1	
		4 830	4 140	3 450	2 800	2.3	
8 PR	142 A6 (134 A8)	3 050	2 615	2 180	1 745	1.0	
		3 380	2 900	2 415	1 930	1.2	
		3 710	3 180	2 650	2 120	1.4	
12 PR	151 A6 (144 A8)	4 580	3 925	3 270	2 620	2.1	
		4 830	4 140	3 450	2 800	2.3	
6 PR	121 A6 (113 A8)	1 610	1 380	1 150	920	1.1	
		1 750	1 500	1 250	1 000	1.3	
		1 890	1 620	1 350	1 080	1.5	
		2 030	1 740	1 450	1 150	1.7	
12 PR	135 A6 (127 A8)	2 610	2 240	1 865	1 490	2.7	
		2 750	2 360	1 965	1 570	2.9	
		2 900	2 485	2 070	1 655	3.1	
		3 050	2 615	2 180	1 750	3.3	
6 PR	125 A6 (118 A8)	1 625	1 390	1 160	930	0.9	
		1 895	1 625	1 355	1 085	1.2	
		2 080	1 780	1 485	1 190	1.4	
		2 310	1 980	1 650	1 320	1.6	
4 PR	106 A8	980	840	700	630	0.8	
		1 225	1 050	875	800	1.0	
		1 330	1 140	950	850	1.1	
		1 465	1 255	1 045	950	1.3	
8 PR	127 A6 (120 A8)	2 070	1 775	1 480	1 185	1.7	
		2 200	1 885	1 570	1 255	1.9	
		2 325	1 990	1 660	1 330	2.1	
		2 450	2 100	1 750	1 400	2.3	
6 PR	126 A6 (119 A8)	1 695	1 450	1 210	970	0.9	
		2 015	1 730	1 440	1 150	1.2	
		2 200	1 885	1 570	1 255	1.4	
		2 380	2 040	1 700	1 360	1.6	
6 PR	126 A6 (119 A8)	1 695	1 450	1 210	970	0.9	
		2 015	1 730	1 440	1 150	1.2	
		2 200	1 885	1 570	1 255	1.4	
		2 380	2 040	1 700	1 360	1.6	

TD series (continued)

Technical data and load capacities

Tyre size	Tread pattern	Type	Rim (permitted)	Tube	Section width (mm)	Overall diameter (mm)	Loaded static radius (mm)	Rolling circumference (mm)	
13.6-38	TD-13	TT	W12 (W11)	13.6-38	345	1 565	740	4 670	
14.9-38	TD-05	TT	W13 (W12)	14.9-38	380	1 640	760	4 838	
15.5-38	TD-05	TT/TL	W14L	15.5-38	394	1 580	745	4 661	
16.9-38	TD-19	TT/TL	W15L (W14L)	16.9-38	429	1 685	795	5 091	
16.9-38	TD-13	TT	W15L (W14L)	16.9-38	429	1 685	795	5 091	
18.4-38	TD-19	TT/TL	W16L (W15L)	18.4-38	467	1 750	814	5 216	

The inflation pressure must be increased for front-end loader tractor application +0.4 bar.
 For Non-standard version, please contact a producer.
 These tyres are for normal agricultural use and not for continuous highway service.



	Ply rating PR	Service description LI/SS	Tyre load capacity (kg) at speed (km/h)				Tyre pressure (bar)
			10	20	30	40	
	14 PR	139 A6 (131 A8)	2 920	2 500	2 085	1 670	2.9
3 075			2 635	2 195	1 755	3.1	
3 235			2 770	2 310	1 850	3.3	
3 400			2 915	2 430	1 950	3.5	
	6 PR	129 A6 (122 A8)	2 190	1 880	1 565	1 250	1.0
2 380			2 040	1 700	1 360	1.2	
2 590			2 220	1 850	1 480	1.4	
	8 PR	133 A6 (125 A8)	2 470	2 120	1 765	1 400	1.4
2 655			2 275	1 895	1 520	1.6	
2 885			2 475	2 060	1 650	1.8	
	8 PR	141 A6 (133 A8)	2 620	2 245	1 870	1 495	1.0
3 050			2 615	2 180	1 745	1.3	
3 325			2 850	2 375	1 900	1.5	
3 605			3 090	2 575	2 060	1.7	
	8 PR	141 A6 (133 A8)	2 620	2 245	1 870	1 495	1.0
3 050			2 615	2 180	1 745	1.3	
3 325			2 850	2 375	1 900	1.5	
3 605			3 090	2 575	2 060	1.7	
	8 PR	143 A6 (135 A8)	3 025	2 590	2 160	1 730	0.9
3 485			2 990	2 490	1 990	1.2	
3 815			3 270	2 725	2 180	1.4	



IM-01

Tested and proven tread pattern for transportation, also suitable for powered wheels.



IM-02

Tread pattern with excellent traction for a wide range of applications.



IM-03

A classic implement design for universal use.



IM-04

Modern universal tread pattern suitable for a wide range of agricultural uses.



IM-06

Ribbed pattern for all sorts of applications.



IM-07

Pattern with rolling rib profile without any lateral tread elements. Suitable for meadowland use or soil cultivation.



IM-08

Ribbed pattern without any lateral tread elements, suitable for meadowland use and transport service.



IM-09

Traction pattern with strong side lugs. Low inflation pressure for reduced soil compaction.

IM series – Implement Diagonal

Great transportation properties



IM-10

Ribbed pattern without any lateral tread elements. Suitable for soil cultivation and for light transport applications.



IM-11

Good track holding for trailed wheels due to rolling rib profile and strong side lugs.



AC 30

Robust tread pattern for construction vehicles.



B 3

Specially designed for garden tractors, large mowers and municipal tractors.



G 1

Perfect tread pattern for small machines and tools as lawn mowers.



B 19

Ribbed tread pattern with rounded shoulder. Good stability and self-cleaning properties. Ideal for small horticultural and hay making machinery.



B 63

Special tread pattern with good stability, lawn protection and comfort.

IM series

Technical data and load capacities

Tyre size	Tread pattern	Type	Rim (permitted)	Tube	Section width (mm)	Overall diameter (mm)	Loaded static radius (mm)	Rolling circumference (mm)	
13×5.00-6	G 1	TL	3.50×6	4.00-6	124	322	148	963	
13×5.00-6	B 19	TL	3.50×6	4.00-6	124	322	148	963	
13×5.00-6	B 19	TL	3.50×6	4.00-6	124	322	148	963	
15×6.00-6	B 19	TL	4.50×6	15×6.00-6	150	362	165	1 082	
16×6.50-8	B 19	TL	5.375×8	16×6.50/7.50-8	165	408	189	1 220	
16×6.50-8	B 19	TL	5.375×8	16×6.50/7.50-8	165	408	189	1 220	
16×6.50-8	B 19	TL	5.375×8	16×6.50/7.50-8	165	408	189	1 220	
18×8.50-8	G 1	TL	7.00×8	18×8.50/9.50-8	214	462	212	1 381	
18.5×8.50-8 (215/65-8)	B 63	TL	7.00×8	18×8.50/9.50-8	215	470	211	1 375	
18.5×8.50-8 (215/65-8)	B 63	TL	7.00×8	18×8.50/9.50-8	215	470	211	1 375	
4.00-10	IM-06	TT	3.00D×10	4.00-10	114	465	230	1 365	
7.00-12	IM-11	TL	4.25×12 5 JA×12(TT)		187 195	687	316	2 070	
10.0/80-12	IM-04	TT/TL	9.00×12 (7.00×12)	10.0/80-12	264	710	316	2 085	
10.0/80-12	IM-04	TL	9.00×12 (7.00×12)	10.0/80-12	264	710	316	2 085	
10.0/80-12	IM-08	TL	9.00×12 (7.00×12)	10.0/80-12	264	735	335	2 160	



	Ply rating PR	Service description LI/SS	Tyre load capacity (kg) at speed (km/h)					Tyre pressure (bar)
			10	20	30	40	50	
	4 PR	49 A4	211	185				2.25
	4 PR	49 A4	211	185				2.25
	8 PR	66 A4	342	300				4.25
	6 PR	72 A4	405	355				3.00
	6 PR	70 A4	382	335				3.00
	10 PR	77 A4	470	412				3.75
	12 PR	80 A4	513	450				4.00
	6 PR	78 A4	485	425				2.75
	6 PR	78 A6	548	485	425			3.50
	12 PR	90 A6	774	684	600			6.30
	4 PR	62 A6	200	175	155	140		1.00
			240	210	185	165		1.50
			285	250	220	200		2.00
			325	285	250	225		2.50
			340	300	265	240		2.75
	6 PR	95 A6	525	465	405	365		1.00
			580	510	445	400		1.20
			685	605	525	475		1.60
			730	650	565	505		1.80
			780	690	600	540		2.00
			885	780	690	610		2.50
	8 PR	112 A8	1 175	1 060	940	840	755	1.75
			1 225	1 105	980	875	790	2.00
			1 330	1 200	1 065	950	855	2.30
			1 360	1 220	1 085	970	875	2.50
			1 450	1 305	1 160	1 035	930	2.75
			1 570	1 410	1 255	1 120	1 010	3.10
	10 PR	117 A8	1 650	1 485	1 320	1 180	1 060	3.40
			1 745	1 570	1 395	1 245	1 120	3.70
			1 800	1 620	1 440	1 285	1 155	3.90
	8 PR	112 A8	1 175	1 060	940	840	755	1.75
			1 225	1 105	980	875	790	2.00
			1 330	1 200	1 065	950	855	2.30
			1 360	1 220	1 085	970	875	2.50
			1 450	1 305	1 160	1 035	930	2.75
			1 570	1 410	1 255	1 120	1 010	3.10

IM series (continued)

Technical data and load capacities

Tyre size	Tread pattern	Type	Rim (permitted)	Tube	Section width (mm)	Overall diameter (mm)	Loaded static radius (mm)	Rolling circumference (mm)	
200/60-14.5	IM-10	TT/TL	6.75 × 14.5		200	620	285	1 823	
28 × 9.00-15	AC 30	TT	7.00 I × 15 6 1/2 K × 15	43GS16	234 229	710	322	2 160	
240/70-15	B 3	TL	7.00 I × 15 6 1/2 K × 15		232 227	721	322	2 135	
10.0/75-15.3	IM-04	TT/TL	9.00 × 15.3	10-15 HS 10/75-15	264	760	351	2 235	
10.0/75-15.3	IM-04	TT/TL	9.00 × 15.3	10-15 HS 10/75-15	264	760	351	2 235	
10.0/75-15.3	IM-04	TT/TL	9.00 × 15.3	10-15 HS 10/75-15	264	760	351	2 235	
10.0/75-15.3	IM-04	TL	9.00 × 15.3	10-15 HS 10/75-15	264	760	351	2 235	
11.5/80-15.3	IM-04	TT/TL	9.00 × 15.3	11.5/80-15	290	845	386	2 485	
11.5/80-15.3	IM-04	TT/TL	9.00 × 15.3	11.5/80-15	290	845	386	2 485	
11.5/80-15.3	IM-04	TT/TL	9.00 × 15.3	11.5/80-15	290	845	386	2 485	
11.5/80-15.3	IM-04	TT/TL	9.00 × 15.3	11.5/80-15	290	845	386	2 485	
12.5/80-15.3	IM-04	TL	9.00 × 15.3	—	307	889	436	2 615	



	Ply rating PR	Service description LI/SS	Tyre load capacity (kg) at speed (km/h)					Tyre pressure (bar)
			10	20	30	40	50	
	10 PR	102 A8	600	540	480	430	390	1.50
			720	650	575	515	465	2.00
			805	725	645	575	520	2.50
			880	795	705	630	565	3.00
			960	865	765	685	615	3.50
			1 035	930	830	740	665	4.00
			1 115	1 000	890	795	715	4.50
			1 190	1 070	950	850	765	5.00
	6 PR	102 A5			(25 km/h)			
			455	435	425			0.70
			510	495	480			0.90
			545	525	510			1.00
			695	670	650			1.50
			810	780	760			2.00
	905	875	850			2.50		
	8 PR	115 A8	1 210	640	580	510		1.00
			1 660	895	790	710	640	1.60
			1 810	970	860	770	690	2.00
			2 500	1 350	1 190	1 070	960	3.00
			2 770	1 485	1 320	1 180	1 060	3.50
			2 860	1 530	1 360	1 215	1 090	4.00
	10 PR	122 A8	1 665	1 500	1 335	1 190	1 070	2.50
			1 850	1 665	1 480	1 320	1 190	3.00
			1 975	1 775	1 580	1 410	1 270	3.50
			2 100	1 890	1 680	1 500	1 350	4.00
	12 PR	125 A8	2 240	2 015	1 790	1 600	1 440	4.50
			2 310	2 080	1 850	1 650	1 485	4.75
	14 PR ⁽¹⁾	130 A8	2 430	2 185	1 945	1 735	1 560	5.00
			2 660	2 395	2 130	1 900	1 710	5.50
	18 PR ⁽¹⁾	143 A8	3 025	2 720	2 420	2 160	1 945	6.00
			3 380	3 045	2 705	2 415	2 175	6.50
			3 815	3 435	3 050	2 725	2 455	7.10
	10 PR	130 A8	2 065	1 860	1 650	1 475	1 330	2.50
			2 430	2 185	1 945	1 735	1 565	3.00
			2 660	2 395	2 130	1 900	1 710	3.50
	12 PR	134 A8	2 815	2 535	2 250	2 010	1 810	3.75
			2 970	2 670	2 375	2 120	1 910	4.00
	14 PR	139 A8	3 260	2 935	2 610	2 330	2 095	4.50
			3 400	3 060	2 720	2 430	2 185	4.75
	16 PR ⁽²⁾	141 A8	3 470	3 125	2 780	2 480	2 230	5.00
			3 605	3 245	2 885	2 575	2 320	5.40
	14 PR	141 A8	2 920	2 625	2 335	2 085	1 875	3.25
			3 110	2 795	2 485	2 220	2 000	3.50
			3 305	2 975	2 645	2 360	2 125	3.70
			3 485	3 135	2 790	2 490	2 240	4.00
			3 605	3 245	2 885	2 575	2 320	4.30

IM series (continued)

Technical data and load capacities

Tyre size	Tread pattern	Type	Rim (permitted)	Tube	Section width (mm)	Overall diameter (mm)	Loaded static radius (mm)	Rolling circumference (mm)	
400/60 - 15.5	IM - 07	TL	13.00×15.5	–	405	875	380	2 575	
400/60 - 15.5	IM - 07	TL	13.00×15.5	–	405	875	380	2 575	
400/60 - 15.5	IM - 07	TL	13.00×15.5	–	405	875	380	2 575	
10.50 - 16	IM - 01	TT	7.00I - 16 (7.0 - 401.5)	10.50 - 16	274	945	432	2 780	
15.0/55 - 17	IM - 04	TL	13.00×17 (13×17)	15.0/55 - 17	391	850	410	2 499	
15.0/55 - 17	IM - 04	TL	13.00×17	15.0/55 - 17	391	850	410	2 499	
19.0/45 - 17	IM - 04	TL	16.00×17	–	491	866	390	2 546	
19.0/45 - 17	IM - 04	TL	16.00×17	–	491	866	390	2 546	
500/50 - 17	IM - 07	TL	16.00×17	–	500	940	420	2 763	
500/50 - 17	IM - 07	TL	16.00×17	–	500	940	420	2 763	
12.5/80 - 18	IM - 03	TT	11×18 (9×18)	12 - 18 HS 12.5 - 18	308	965	444	2 840	



	Ply rating PR	Service description LI/SS	Tyre load capacity (kg) at speed (km/h)					Tyre pressure (bar)
			10	20	30	40	50	
	14 PR	140 A8	2 015	1 815	1 615	1 440	1 295	1.25
			2 185	1 965	1 745	1 560	1 405	1.50
			2 520	2 270	2 015	1 800	1 620	2.00
			2 800	2 520	2 240	2 000	1 800	2.50
			3 150	2 835	2 520	2 250	2 025	3.00
			3 500	3 150	2 800	2 500	2 250	3.50
	–	145 A8	4 060	3 650	3 250	2 900	2 610	3.60
	–	152 A8	4 410	3 970	3 530	3 150	2 835	4.00
			4 690	4 220	3 750	3 350	3 015	5.00
			4 970	4 475	3 975	3 550	3 195	6.00
	14 PR	144 A8	2 870	2 585	2 295	2 050	1 845	3.25
			2 970	2 670	2 375	2 120	1 910	3.50
			3 220	2 900	2 575	2 300	2 070	4.00
			3 470	3 125	2 780	2 480	2 230	4.50
			3 710	3 340	2 970	2 650	2 385	5.00
			3 920	3 530	3 135	2 800	2 520	5.25
	10 PR	131 A8	2 325	2 090	1 860	1 660	1 495	2.00
			2 595	2 335	2 080	1 855	1 670	2.40
			2 730	2 455	2 185	1 950	1 755	2.60
	14 PR	137 A8	2 830	2 545	2 260	2 020	1 820	2.80
			2 970	2 670	2 375	2 120	1 910	3.10
			3 050	2 745	2 440	2 180	1 960	3.30
			3 135	2 820	2 510	2 240	2 015	3.50
			3 220	2 900	2 575	2 300	2 070	3.70
	14 PR	144 A8	2 605	2 345	2 085	1 860	1 675	2.00
			2 980	2 685	2 385	2 130	1 915	2.50
			3 305	2 975	2 645	2 360	2 125	3.00
			3 625	3 265	2 900	2 590	2 330	3.50
			3 920	3 530	3 135	2 800	2 520	4.00
	18 PR	157 A8	5 110	4 600	4 090	3 650	3 285	4.75
			5 320	4 790	4 255	3 800	3 420	5.00
			5 545	4 990	4 435	3 960	3 565	5.25
			5 775	5 195	4 620	4 125	3 715	5.50
	14 PR	149 A8	3 330	3 000	2 665	2 380	2 140	2.00
			3 815	3 435	3 050	2 725	2 455	2.50
			4 200	3 780	3 360	3 000	2 700	3.00
			4 550	4 095	3 640	3 250	2 925	3.50
	18 PR	155 A8	4 985	4 485	3 985	3 560	3 200	4.00
			5 425	4 880	4 340	3 875	3 490	4.40
	14 PR	145 A8	2 715	2 445	2 175	1 940	1 745	2.25
			2 885	2 595	2 305	2 060	1 855	2.50
			3 305	2 975	2 645	2 360	2 125	3.00
			3 565	3 205	2 850	2 545	2 290	3.50
			3 870	3 485	3 095	2 765	2 490	4.00
			4 060	3 655	3 250	2 900	2 610	4.25

IM series (continued)

Technical data and load capacities

Tyre size	Tread pattern	Type	Rim (permitted)	Tube	Section width (mm)	Overall diameter (mm)	Loaded static radius (mm)	Rolling circumference (mm)	
12.5/80-18	IM-03	TT	11×18 (9×18)	12-18 HS 12.5-18	308	965	444	2 840	
12.5/80-18	IM-04	TT	11×18 (9×18)	12-18 HS 12.5-18	308	965	444	2 840	
12.5/80-18	IM-04	TT	11×18 (9×18)	12-18 HS 12.5-18	308	965	444	2 840	
13.0/65-18	IM-04	TT	11×18	13.0/65-18	336	890	412	2 615	
360/95-18 (13.00-18)	IM-02	TT	9A×18	12.00-18	370	1 128	514	3 315	
14.5/80-18	IM-03	TT	13×18	14.5/80-18	372	1 045	475	3 075	
500/60-22.5	IM-09	TL	16.00×22.5	–	503	1 172	511	3 446	
550/60-22.5	IM-09	TL	16.00×22.5	–	537	1 232	534	3 622	

¹⁾ Reinforced version also available (REINFORCED)

²⁾ Reinforced version for TT type also available (REINFORCED)

For Non-standard version, please contact a producer.

These tyres are for normal agricultural use and not for continuous highway service.



	Ply rating PR	Service description LI/SS	Tyre load capacity (kg) at speed (km/h)					Tyre pressure (bar)
			10	20	30	40	50	
	16 PR	147 A8	4 145 4 305	3 730 3 875	3 315 3 445	2 960 3 075	2 665 2 770	4.50 5.00
	14 PR	145 A8	2 715 2 885 3 305 3 565 3 870 4 060	2 445 2 595 2 975 3 205 3 485 3 655	2 175 2 305 2 645 2 850 3 095 3 250	1 940 2 060 2 360 2 545 2 765 2 900	1 745 1 855 2 125 2 290 2 490 2 610	2.25 2.50 3.00 3.50 4.00 4.25
	16 PR	147 A8	4 145 4 305	3 730 3 875	3 315 3 445	2 960 3 075	2 665 2 770	4.50 5.00
	16 PR	143 A8	2 270 2 575 2 885 3 220 3 400 3 605 3 815	2 040 2 320 2 595 2 900 3 060 3 245 3 435	1 815 2 060 2 305 2 575 2 720 2 885 3 050	1 620 1 840 2 060 2 300 2 430 2 575 2 725	1 460 1 655 1 855 2 070 2 185 2 320 2 455	2.00 2.50 3.00 3.50 4.00 4.50 5.00
	12 PR	150 A8	3 555 4 200 4 690	3 200 3 780 4 220	2 845 3 360 3 750	2 540 3 000 3 350	2 285 2 700 3 015	2.50 3.00 3.50
	12 PR	155 A8	2 850 3 310 3 765 4 215 4 660 5 125 5 425	2 565 2 980 3 390 3 795 4 195 4 610 4 885	2 280 2 650 3 015 3 370 3 730 4 100 4 340	2 035 2 365 2 690 3 010 3 330 3 660 3 875	1 830 2 130 2 420 2 710 2 995 3 295 3 490	1.50 2.00 2.50 3.00 3.50 4.00 4.25
	16 PR	159 A8	3 955 4 390 4 825 5 250 5 690 6 125	3 560 3 950 4 340 4 725 5 120 5 515	3 165 3 510 3 860 4 200 4 555 4 900	2 825 3 135 3 445 3 750 4 065 4 375	2 545 2 820 3 100 3 375 3 660 3 940	1.50 1.80 2.10 2.40 2.70 3.00
	16 PR	163 A8	4 780 5 125 5 455 5 775 6 235 6 530 6 825	4 305 4 610 4 910 5 200 5 615 5 880 6 145	3 825 4 100 4 360 4 620 4 990 5 225 5 460	3 415 3 660 3 895 4 125 4 455 4 665 4 875	3 075 3 295 3 505 3 715 4 010 4 200 4 390	1.50 1.70 1.90 2.10 2.40 2.60 2.80



TR-01

Tread pattern with excellent traction, suitable for all self-propelled machines, agricultural loaders, small dump trucks and telescopic loaders.



TR-03

Universal traction pattern for different agricultural applications.



TR-04

All-round tread pattern with great traction for a wide range of agricultural uses.



TR-05

Time proven pattern for agricultural application with very good traction.



TR-06

Low-profile traction pattern for use in meadowlands, suitable for drive wheels.



TR-07

Low-profile tread pattern with great traction, recommended for meadowland use.



TR-08

Flotation pattern with reduced soil compaction due to low inflation pressure. Great traction, breaking performance and lateral stability.



TR-09

Traction pattern suitable for front wheels of backhoe loaders and wheel loaders.

TR series – Implement Diagonal Traction tyres for wide agricultural application



TR-10

Tread pattern suitable above all for **bigger skid-steer loaders or self-propelled plat-forms**. Recommended also for front wheels of back-hoe loaders.



TR-11

Tread pattern with robust lugs, ensuring very good traction. Suitable for **loaders and side dumpers**.



TR-12

Pattern with excellent traction, developed for **powered wheels of agricultural and industrial machinery**. Applicable for trailed wheels as well.

Tyre size	TR-01	TR-03	TR-04	TR-05	TR-06	TR-07	TR-08	TR-10	TR-11	TR-12
31x15.50-15					•	•				
10.0/75-15.3		•	•							
11.5/80-15.3		•								
400/60-15.5							•			
15.0/55-17	•									
480/45-17	•									
14-17.5								•		
12.0/75-18		•							•	
14.5/80-18				•						
400/70-20	•									
500/45-20										•
500/60-22.5							•			•
550/60-22.5							•			
600/40-22.5										•
600/50-22.5							•			



TR series

Technical data and load capacities

Tyre size	Tread pattern	Type	Rim (permitted)	Tube	Section width (mm)	Overall diameter (mm)	Loaded static radius (mm)	Rolling circumference (mm)
31×15.50-15 (400/50-15)	TR-06	TL	13LB×15	–	370	760	350	2 235
31×15.50-15 (400/50-15)	TR-07	TL	13LB×15	–	370	760	350	2 235
10.0/75-15.3	TR-03	TL	9.00×15.3	10-15 HS 10/75-15	264	780	360	2 295
10.0/75-15.3	TR-03	TL	9.00×15.3	10-15 HS 10/75-15	264	780	360	2 295
10.0/75-15.3	TR-03	TL	9.00×15.3	10-15 HS 10/75-15	264	780	360	2 295
10.0/75-15.3	TR-04	TT/TL	9.00×15.3	10-15 HS 10/75-15	264	780	360	2 295
11.5/80-15.3	TR-03	TL	9.00×15.3	11.5/80-15	290	867	395	2 550
11.5/80-15.3	TR-03	TT/TL	9.00×15.3	11.5/80-15	290	867	395	2 550
400/60-15.5	TR-08	TL	13.00×15.5	–	390	865	385	2 546
400/60-15.5	TR-08	TL	13.00×15.5	–	390	865	385	2 546



	Ply rating PR	Service description L/SS	Tyre load capacity (kg) – free rolling / drive wheel – at speed (km/h)					Tyre pressure (bar)
			10	20	30	40	50	
8 PR	121/109 A8	1 045 / 730	940 / 655	835 / 580	745 / 520	670 / 470	1.00	
		1 295 / 910	1 165 / 820	1 035 / 730	925 / 650	835 / 585	1.50	
		1 555 / 1 090	1 400 / 985	1 245 / 875	1 110 / 780	1 000 / 700	2.00	
		1 805 / 1 265	1 625 / 1 140	1 445 / 1 015	1 290 / 905	1 160 / 815	2.50	
		2 030 / 1 440	1 825 / 1 300	1 625 / 1 155	1 450 / 1 030	1 305 / 925	3.00	
8 PR	121/109 A8	1 045 / 730	940 / 655	835 / 580	745 / 520	670 / 470	1.00	
		1 295 / 910	1 165 / 820	1 035 / 730	925 / 650	835 / 585	1.50	
		1 555 / 1 090	1 400 / 985	1 245 / 875	1 110 / 780	1 000 / 700	2.00	
		1 805 / 1 265	1 625 / 1 140	1 445 / 1 015	1 290 / 905	1 160 / 815	2.50	
		2 030 / 1 440	1 825 / 1 300	1 625 / 1 155	1 450 / 1 030	1 305 / 925	3.00	
10 PR	122/111 A8	1 665 / 1 210	1 500 / 1 090	1 335 / 970	1 190 / 865	1 070 / 780	2.50	
		1 755 / 1 275	1 580 / 1 145	1 405 / 1 020	1 255 / 910	1 130 / 820	2.75	
		1 850 / 1 330	1 665 / 1 195	1 480 / 1 065	1 320 / 950	1 190 / 855	3.00	
		1 910 / 1 380	1 720 / 1 240	1 530 / 1 105	1 365 / 985	1 230 / 885	3.25	
		1 975 / 1 430	1 775 / 1 285	1 580 / 1 140	1 410 / 1 020	1 270 / 920	3.50	
2 100 / 1 525	1 890 / 1 375	1 680 / 1 220	1 500 / 1 090	1 350 / 980	4.00			
12 PR	125/114 A8	2 170 / 1 570	1 955 / 1 410	1 735 / 1 255	1 550 / 1 120	1 395 / 1 010	4.25	
		2 240 / 1 610	2 015 / 1 450	1 790 / 1 290	1 600 / 1 150	1 440 / 1 035	4.50	
		2 310 / 1 650	2 080 / 1 485	1 850 / 1 320	1 650 / 1 180	1 485 / 1 060	4.75	
14 PR	130/118 A8	2 430 / 1 715	2 185 / 1 545	1 945 / 1 370	1 735 / 1 225	1 560 / 1 105	5.00	
		2 550 / 1 780	2 295 / 1 600	2 040 / 1 420	1 820 / 1 270	1 640 / 1 145	5.25	
		2 660 / 1 850	2 395 / 1 665	2 130 / 1 480	1 900 / 1 320	1 710 / 1 190	5.50	
10 PR	122/111 A8	1 665 / 1 210	1 500 / 1 090	1 335 / 970	1 190 / 865	1 070 / 780	2.50	
		1 755 / 1 275	1 580 / 1 145	1 405 / 1 020	1 255 / 910	1 130 / 820	2.75	
		1 850 / 1 330	1 665 / 1 195	1 480 / 1 065	1 320 / 950	1 190 / 855	3.00	
		1 910 / 1 380	1 720 / 1 240	1 530 / 1 105	1 365 / 985	1 230 / 885	3.25	
		1 975 / 1 430	1 775 / 1 285	1 580 / 1 140	1 410 / 1 020	1 270 / 920	3.50	
2 100 / 1 525	1 890 / 1 375	1 680 / 1 220	1 500 / 1 090	1 350 / 980	4.00			
10 PR	130/119 A8	1 820 / 1 510	1 640 / 1 360	1 455 / 1 210	1 300 / 1 080	1 170 / 970	2.25	
		2 065 / 1 580	1 860 / 1 425	1 650 / 1 265	1 475 / 1 130	1 330 / 1 015	2.50	
		2 430 / 1 735	2 185 / 1 560	1 945 / 1 390	1 735 / 1 240	1 560 / 1 115	3.00	
		2 660 / 1 905	2 395 / 1 715	2 130 / 1 525	1 900 / 1 360	1 710 / 1 225	3.50	
14 PR	139/126 A8	2 970 / 2 170	2 670 / 1 955	2 375 / 1 735	2 120 / 1 550	1 910 / 1 395	4.00	
		3 260 / 2 310	2 935 / 2 080	2 610 / 1 850	2 330 / 1 650	2 095 / 1 485	4.50	
		3 400 / 2 380	3 060 / 2 140	2 720 / 1 905	2 430 / 1 700	2 185 / 1 530	4.75	
14 PR	140/127 A8	2 015 / 1 420	1 815 / 1 280	1 615 / 1 135	1 440 / 1 015	1 295 / 915	1.25	
		2 185 / 1 525	1 965 / 1 375	1 745 / 1 220	1 560 / 1 090	1 405 / 980	1.50	
		2 520 / 1 750	2 270 / 1 575	2 015 / 1 400	1 800 / 1 250	1 620 / 1 125	2.00	
		2 800 / 1 975	2 520 / 1 775	2 240 / 1 580	2 000 / 1 410	1 800 / 1 270	2.50	
		3 150 / 2 205	2 835 / 1 985	2 520 / 1 765	2 250 / 1 575	2 025 / 1 420	3.00	
		3 500 / 2 450	3 150 / 2 205	2 800 / 1 960	2 500 / 1 750	2 250 / 1 575	3.50	
(4)	145/132 A8	4 060 / 2 800	3 650 / 2 520	3 250 / 2 240	2 900 / 2 000	2 610 / 1 800	3.60	



TR series (continued)

Technical data and load capacities

Tyre size	Tread pattern	Type	Rim (permitted)	Tube	Section width (mm)	Overall diameter (mm)	Loaded static radius (mm)	Rolling circumference (mm)	
400/60 - 15.5	TR-08	TL	13.00×15.5	–	390	865	385	2 546	
15.0/55 - 17	TR-01	TL	13.00×17 (13×17)	–	391	872	410	2 565	
15.0/55 - 17	TR-01	TL	13.00×17 (13×17)	–	391	872	410	2 565	
15.0/55 - 17	TR-01	TL	13.00×17	–	391	872	410	2 565	
480/45 - 17 IMP	TR-01	TL	15.00×17 (16.00×17)	–	479	864	410	2 576	
14 - 17.5	TR-10	TL	10.50×17.5	–	355	910	430	2 858	
12.0/75 - 18	TR-03	TL	W9×18 (9.11×18)	12.0 - 18	299	937	447	2 755	
12.0/75 - 18	TR-11	TL	W9×18 (9.11×18)	12.0 - 18	299	937	447	2 755	
14.5/80 - 18	TR-05	TT	13×18	14.5/80 - 18	372	1 045	475	3 075	
500/45 - 20	TR-12	TL	16.00×20 DC	–	490	980	445	2 910	



	Ply rating PR	Service description L/SS	Tyre load capacity (kg) – free rolling / drive wheel – at speed (km/h)					Tyre pressure (bar)
			10	20	30	40	50	
		152/140 A8	4410 / 3135 4690 / 3305 4970 / 3500	3970 / 2820 4220 / 2975 4475 / 3150	3530 / 2510 3750 / 2645 3975 / 2800	3150 / 2240 3350 / 2360 3550 / 2500	2835 / 2015 3015 / 2125 3195 / 2250	4.00 5.00 6.00
	10 PR	131/119 A8	2 325 / 1 615 2 465 / 1 710 2 595 / 1 815 2 730 / 1 905	2 090 / 1 455 2 220 / 1 535 2 335 / 1 630 2 455 / 1 715	1 860 / 1 295 1 970 / 1 365 2 080 / 1 450 2 185 / 1 525	1 660 / 1 155 1 760 / 1 220 1 855 / 1 295 1 950 / 1 360	1 495 / 1 040 1 585 / 1 100 1 670 / 1 165 1 755 / 1 225	2.00 2.20 2.40 2.60
	12 PR	134/122 A8	2 830 / 1 990 2 970 / 2 100	2 545 / 1 790 2 670 / 1 890	2 260 / 1 590 2 375 / 1 680	2 020 / 1 420 2 120 / 1 500	1 820 / 1 280 1 910 / 1 350	2.80 3.10
	14 PR	137/125A8	3 050 / 2 135 3 135 / 2 200 3 220 / 2 310	2 745 / 1 920 2 820 / 1 980 2 900 / 2 080	2 440 / 1 710 2 510 / 1 760 2 575 / 1 850	2 180 / 1 525 2 240 / 1 570 2 300 / 1 650	1 960 / 1 370 2 015 / 1 415 2 070 / 1 485	3.30 3.50 3.70
	–	146/134 A8	1 638 / 1 158 2 100 / 1 484 2 604 / 1 840 2 982 / 2 107 3 444 / 2 434 3 906 / 2 760 4 200 / 2 968	1 474 / 1 042 1 890 / 1 336 2 344 / 1 656 2 684 / 1 897 3 100 / 2 190 3 515 / 2 484 3 780 / 2 671	1 310 / 926 1 680 / 1 187 2 083 / 1 472 2 386 / 1 686 2 755 / 1 947 3 125 / 2 208 3 360 / 2 374	1 170 / 827 1 500 / 1 060 1 860 / 1 314 2 130 / 1 505 2 460 / 1 738 2 790 / 1 972 3 000 / 2 120	1 053 / 744 1 350 / 954 1 674 / 1 183 1 917 / 1 355 2 214 / 1 565 2 511 / 1 774 2 700 / 1 908	0.80 1.20 1.60 2.00 2.40 2.80 3.20
	14 PR	150/139 B	3 890 / 2 760 4 060 / 2 890 4 240 / 3 030 4 410 / 3 165 4 640 / 3 345 4 930 / 3 565 5 210 / 3 780	3 505 / 2 480 3 655 / 2 600 3 820 / 2 730 3 970 / 2 850 4 175 / 3 010 4 435 / 3 205 4 685 / 3 400	3 115 / 2 205 3 250 / 2 315 3 395 / 2 425 3 530 / 2 530 3 715 / 2 675 3 940 / 2 850 4 166 / 3 025	2 780 / 1 970 2 900 / 2 065 3 030 / 2 165 3 150 / 2 260 3 315 / 2 390 3 520 / 2 545 3 720 / 2 700	2 500 / 1 775 2 610 / 1 860 2 725 / 1 950 2 835 / 2 035 2 985 / 2 150 3 170 / 2 290 3 350 / 2 430	3.20 3.50 3.80 4.10 4.50 5.00 5.50
	12 PR	139/126 A8	3 150 / 2 225 3 400 / 2 380	2 835 / 2 005 3 060 / 2 140	2 520 / 1 780 2 720 / 1 905	2 250 / 1 590 2 430 / 1 700	2 025 / 1 430 2 185 / 1 530	3.50 4.00
	12 PR	135/123 A8	2 490 / 1 800 2 610 / 1 870 2 835 / 2 025 3 050 / 2 170	2 245 / 1 620 2 350 / 1 680 2 550 / 1 820 2 745 / 1 955	1 995 / 1 440 2 090 / 1 500 2 270 / 1 620 2 440 / 1 735	1 780 / 1 285 1 865 / 1 335 2 025 / 1 445 2 180 / 1 550	1 600 / 1 155 1 680 / 1 200 1 825 / 1 300 1 960 / 1 395	2.75 3.00 3.50 4.00
	12 PR	155/143 A8	3 765 / 2 660 4 445 / 3 155 4 895 / 3 485 5 425 / 3 815	3 390 / 2 395 4 000 / 2 840 4 405 / 3 135 4 885 / 3 435	3 015 / 2 130 3 555 / 2 525 3 915 / 2 790 4 340 / 3 050	2 690 / 1 900 3 175 / 2 255 3 495 / 2 490 3 875 / 2 725	2 420 / 1 710 2 860 / 2 030 3 145 / 2 240 3 490 / 2 455	2.50 3.25 3.75 4.25
		162/150 A8	5 775 / 4 060 6 125 / 4 305 6 650 / 4 690	5 200 / 3 655 5 510 / 3 875 5 985 / 4 220	4 620 / 3 250 4 900 / 3 445 5 320 / 3 750	4 125 / 2 900 4 375 / 3 075 4 750 / 3 350	3 710 / 2 610 3 940 / 2 770 4 275 / 3 015	4.00 5.00 6.00



TR series (continued)

Technical data and load capacities

Tyre size	Tread pattern	Type	Rim (permitted)	Tube	Section width (mm)	Overall diameter (mm)	Loaded static radius (mm)	Rolling circumference (mm)
500/60 - 22.5	TR-08	TL	16.00×22.5	–	503	1 192	519	3 504
500/60 - 22.5	TR-12	TL	16.00×22.5 DC	–	503	1 192	519	3 504
500/60 - 22.5	TR-12	TL	16.00×22.5	–	503	1 192	519	3 504
550/60 - 22.5	TR-08	TL	16.00×22.5	–	537	1 254	542	3 687
550/60 - 22.5	TR-08	TL	16.00×22.5	–	537	1 254	542	3 687
600/40 - 22.5	TR-12	TL	20.00TH2×22.5 (20.00DC)	–	600	1 050	473	3 146
600/40 - 22.5	TR-12	TL	20.00TH2×22.5 (20.00DC)	–	600	1 050	473	3 146
600/50 - 22.5	TR-08	TL	20.00×22.5	–	595	1 140	510	3 380
600/50 - 22.5	TR-08 HD	TL	20.00×22.5	–	611	1 172	510	3 440

¹⁾ Reinforced version (REINFORCED)

For Non-standard version, please contact a producer.
These tyres are for normal agricultural use and not for continuous highway service.



	Ply rating PR	Service description L/SS	Tyre load capacity (kg) – free rolling / drive wheel – at speed (km/h)					Tyre pressure (bar)
			10	20	30	40	50	
	16 PR	159/147 A8	3 955 / 2 700	3 560 / 2 430	3 165 / 2 160	2 825 / 1 930	2 545 / 1 735	1.50
4 390 / 3 050			3 950 / 2 745	3 510 / 2 440	3 135 / 2 180	2 820 / 1 960	1.80	
4 825 / 3 390			4 340 / 3 050	3 860 / 2 710	3 445 / 2 420	3 100 / 2 180	2.10	
5 250 / 3 710			4 725 / 3 340	4 200 / 2 970	3 750 / 2 650	3 375 / 2 385	2.40	
5 690 / 4 010			5 120 / 3 610	4 555 / 3 210	4 065 / 2 865	3 660 / 2 580	2.70	
6 125 / 4 305			5 515 / 3 875	4 900 / 3 445	4 375 / 3 075	3 940 / 2 770	3.00	
	165/153 A8	6125 / 4305	5510 / 3875	4900 / 3445	4375 / 3075	3940 / 2770	2.80	
6650 / 4690		5985 / 4220	5320 / 3750	4750 / 3350	4275 / 3015	3.20		
7210 / 4970		6490 / 4475	5780 / 3975	5150 / 3550	4635 / 3195	3.60		
	170/158 A8	7 840 / 5 600	7 055 / 5 040	6 270 / 4 480	5 600 / 4 000	5 040 / 3 600	4.00	
8 400 / 5 950		7 560 / 5 355	6 720 / 4 760	6 000 / 4 250	5 400 / 3 825	4.50		
	16 PR	167/155 A8	3 205 / 2 279	2 884 / 2 051	2 564 / 1 823	2 289 / 1 628	2 060 / 1 465	0.80
4 120 / 2 930			3 708 / 2 637	3 296 / 2 344	2 943 / 2 093	2 649 / 1 883	1.20	
5 036 / 3 581			4 532 / 3 222	4 029 / 2 864	3 597 / 2 558	3 237 / 2 302	1.60	
5 799 / 4 123			5 219 / 3 711	4 639 / 3 298	4 142 / 2 945	3 728 / 2 651	2.00	
6 714 / 4 774			6 043 / 4 297	5 372 / 3 819	4 796 / 3 410	4 316 / 3 069	2.40	
7 630 / 5 425			6 867 / 4 883	6 104 / 4 340	5 450 / 3 875	4 905 / 3 488	2.80	
	171/159 A8	7 060 / 4 940	6 495 / 4 540	5 930 / 4 150	5 650 / 3 950	4 800 / 3 360	3.00	
7 360 / 5 220		6 775 / 4 800	6 185 / 4 385	5 890 / 4 175	5 005 / 3 550	3.20		
7 700 / 5 470		7 070 / 5 030	6 500 / 4 640	6 150 / 4 375	5 225 / 3 720	3.40		
	161/149 A8	2 520 / 1 750	2 270 / 1 575	2 015 / 1 400	1 800 / 1 250	1 620 / 1 125	0.80	
3 220 / 2 310		2 900 / 2 080	2 575 / 1 850	2 300 / 1 650	2 070 / 1 485	1.20		
3 920 / 2 800		3 530 / 2 520	3 135 / 2 240	2 800 / 2 000	2 520 / 1 800	1.60		
4 550 / 3 220		4 095 / 2 900	3 640 / 2 575	3 250 / 2 300	2 925 / 2 070	2.00		
5 250 / 3 710		4 725 / 3 340	4 200 / 2 970	3 750 / 2 650	3 375 / 2 385	2.40		
5 950 / 4 200		5 355 / 3 780	4 760 / 3 360	4 250 / 3 000	3 825 / 2 700	2.80		
6 475 / 4 550	5 830 / 4 095	5 180 / 3 640	4 625 / 3 250	4 160 / 2 925	3.20			
	172/160 A8	7 000 / 4 970	6 300 / 4 475	5 600 / 3 975	5 000 / 3 550	4 500 / 3 195	3.60	
7 840 / 5 600		7 055 / 5 040	6 270 / 4 480	5 600 / 4 000	5 040 / 3 600	4.00		
8 120 / 5 775		7 310 / 5 200	6 495 / 4 620	5 800 / 4 125	5 220 / 3 710	5.00		
8 820 / 6 300		7 940 / 5 670	7 055 / 5 040	6 300 / 4 500	5 670 / 4 050	6.00		
	16 PR	165/153 A8	4 440 / 3 025	3 995 / 2 720	3 550 / 2 420	3 170 / 2 160	2 855 / 1 945	1.10
4 830 / 3 305			4 345 / 2 975	3 865 / 2 645	3 450 / 2 360	3 105 / 2 125	1.30	
5 395 / 3 690			4 855 / 3 320	4 320 / 2 950	3 855 / 2 635	3 470 / 2 370	1.60	
5 760 / 3 940			5 185 / 3 545	4 610 / 3 155	4 115 / 2 815	3 705 / 2 535	1.80	
6 125 / 4 200			5 515 / 3 780	4 900 / 3 360	4 375 / 3 000	3 940 / 2 700	2.00	
6 670 / 4 650			6 005 / 4 185	5 335 / 3 720	4 765 / 3 320	4 290 / 2 990	2.30	
7 210 / 5 110			6 490 / 4 600	5 770 / 4 090	5 150 / 3 650	4 635 / 3 285	2.60	
168/156 A8			7 840 / 5 600	7 055 / 5 040	6 270 / 4 480	5 600 / 4 000	5 040 / 3 600	3.20



TS-01

Classic tread pattern with excellent traction.



TS-02

Universal traction pattern for a wide range of gardening applications.



TS-03

Tread pattern with deep and robust lugs for greater traction.



TS-04

All-round tread pattern with excellent traction.



TS-05

Pattern with very good traction and handling. Also suitable for light industrial use.



TS-06

Improved tread pattern with great traction.



TS-07

Pattern specially developed for seed drill machines for soil compaction. Applicable for drive wheels as well.



TD-10

Lugged tread pattern for powered axle.

Tractor small tyres

For all kinds of gardening equipment



TD-13

A classic tread pattern design, well-tested and proven.



B 12

Universal traction pattern for a wide range of gardening applications.



B 16

Tread pattern with deep and robust lugs for greater traction.



B 17

Lugged tread pattern with excellent traction.



B 18

Universal tread pattern with great traction.



B 64

Universal traction pattern for a wide range of gardening applications.

Tractor Small Tyres

Technical data and load capacities

Tyre size	Tread pattern	Type	Rim (permitted)	Tube	Section width (mm)	Overall diameter (mm)	Loaded static radius (mm)	Rolling circumference (mm)
3.50-6	B 16	TT	2.50×6	4.00-6	96	343	157	1 026
13×5.00-6	B 12	TT/TL	3.50×6	4.00-6	120	328	151	981
3.50-8	B 16	TT	2.50×8	3.50/4.00-8	96	395	183	1 181
4.00-8	TS-01	TT	3.00D×8	4.00-8	114	425	195	1 250
4.00-8	B 12	TT	3.00×8	3.50/4.00-8	105	425	196	1 271
4.00-8	B 12	TT	3.00×8	3.50/4.00-8	105	425	196	1 271
16×6.50-8	B 64	TT/TL	5.375×8	16×6.50/7.50-8	165	408	189	1 220
16×6.50-8	B 64	TT/TL	5.375×8	16×6.50/7.50-8	165	408	189	1 220
4.00-10	B 12	TT	3.00×10	4.00-10	109	470	219	1 405
4.00-10	B 12	TTT	3.00×10	4.00-10	109	470	219	1 405
4.0-10	TS-03	TT	3.50B×10 (3.00B×10)	4.0-10	114	463	214	1 370
4.0-10	B 17	TT	3.50×10	4.00-10	111	460	215	1 375
5.00-10	B 16	TT	3.00×10	5.00-10	132	520	240	1 555
5.0-10	TS-03	TT	4J×10 (3.50B×10)	5.0-10	140	512	234	1 520
5.0-10	TS-03	TT	4J×10 (3.50B×10)	5.0-10	140	512	234	1 520
5.0-10	B 17	TT	3.50×10	5.00-10	135	515	238	1 540
5.0-10	B 17	TT	3.50×10	5.00-10	135	515	238	1 540
4.00-12	B 12	TT	3.00×12	4.00-12	109	530	248	1 585
5.00-12	TS-02	TT	4.00E×12 (3.00D×12)	5.00-12	145	580	260	1 705
5.00-12	TS-02	TT	4.00E×12 (3.00D×12)	5.00-12	145	580	260	1 705
5.00-12	TS-02	TT	4.00E×12 (3.00D×12)	5.00-12	145	580	260	1 705
5.00-12	B 12	TT	4.00×12	5.00-12	145	575	267	1 719
5.00-12	B 12	TT	4.00×12	5.00-12	145	575	267	1 719



	Ply rating PR	Service description L/SS	Tyre load capacity (kg) – free rolling / drive wheel – at speed (km/h)					Tyre pressure (bar)
			10	20	25	30	40	
	4 PR	33 A6	- / 148	- / 131	- / 123	- / 115		3.00
	4 PR	49 A6	- / 239	- / 211	- / 198	- / 185		2.25
	4 PR	35 A6	- / 156	- / 138	- / 129	- / 121		3.00
	2 PR ¹⁾	43/31 A6	130 / 90	115 / 80	105 / 75	100 / 70	90 / 65	0.80
			175 / 125	155 / 110	145 / 100	135 / 95	120 / 90	1.00
			200 / 140	175 / 125	165 / 115	155 / 109	140 / 100	1.50
	2 PR	31 A6	- / 141	- / 124	- / 117	- / 109		1.50
	4 PR	44 A6	- / 206	- / 182	- / 171	- / 160		2.75
	4 PR	52 A6	- / 258	- / 228	- / 214	- / 200		1.90
	8 PR	69 A6	- / 419	- / 371	- / 348	- / 325		4.25
	2 PR	37 A6	- / 165	- / 146	- / 137	- / 128		1.50
	4 PR	49 A6	- / 239	- / 211	- / 198	- / 185		2.75
	4 PR	49/37 A8	205 / 150	185 / 135	175 / 125	160 / 115	145 / 105	0.80
			215 / 155	195 / 135	185 / 130	170 / 120	155 / 109	1.00
			225 / 165	200 / 145	190 / 135	180 / 125	160 / 115	1.25
			230 / 165	210 / 155	195 / 140	185 / 130	165 / 120	1.50
			260 / 180	235 / 160	220 / 150	200 / 145	185 / 128	1.90
	2 PR	40 A6	- / 181	- / 160	- / 150	- / 140		1.50
	4 PR	59 A6	- / 313	- / 277	- / 260	- / 243		2.25
	2 PR	57/44 A8	285 / 205	260 / 185	245 / 175	230 / 160	205 / 145	0.80
			320 / 225	290 / 200	275 / 195	255 / 180	230 / 160	1.00
	4 PR	70/58 A8	355 / 255	320 / 230	305 / 225	285 / 205	255 / 185	1.25
			400 / 280	360 / 255	340 / 240	315 / 225	285 / 200	1.50
			470 / 330	420 / 295	400 / 280	375 / 265	335 / 236	2.00
	2 PR	48 A6	- / 232	- / 205	- / 193	- / 180		1.25
	4 PR	61 A6	- / 332	- / 293	- / 275	- / 257		2.25
	4 PR	54 A6	- / 273	- / 242	- / 227	- / 212		2.75
	2 PR	61/48 A6	290 / 200	255 / 180	240 / 165	225 / 155	205 / 140	1.00
			330 / 230	295 / 205	275 / 195	257 / 180	230 / 165	1.25
	4 PR	74/62 A6	370 / 260	325 / 230	305 / 215	285 / 200	255 / 180	1.50
			405 / 295	360 / 260	335 / 245	315 / 225	285 / 205	1.75
			445 / 320	395 / 280	370 / 260	345 / 245	310 / 225	2.00
	6 PR	78/66 A6	485 / 340	430 / 300	400 / 285	375 / 265	340 / 240	2.25
			495 / 350	440 / 310	410 / 290	385 / 270	345 / 245	2.50
			520 / 370	460 / 325	435 / 305	405 / 285	365 / 260	3.00
			550 / 390	485 / 345	455 / 325	425 / 300	385 / 270	3.50
			2 PR	48 A6	- / 232	- / 205	- / 193	- / 180
	4 PR	62 A6	- / 342	- / 302	- / 284	- / 265		2.25

Tractor Small Tyres (continued)

Technical data and load capacities

Tyre size	Tread pattern	Type	Rim (permitted)	Tube	Section width (mm)	Overall diameter (mm)	Loaded static radius (mm)	Rolling circumference (mm)	
6.5/90-12 (170/90-12)	TS-06	TT	5J×12 (5JA×12)	6.5/80-12	165	615	278	1 810	
6.5/90-12 (170/90-12)	TS-06	TT	5J×12 (5JA×12)	6.5/80-12	165	615	278	1 810	
6.5/80-12	B 18	TT	5.00×12	5.00-12	165	600	278	1 794	
11.0/65-12	TD-10	TT	9.00×12 (7.00×12)	–	281 261	692	310	2 125	
6.5/75-14	TS-02	TT	5J×14	155/165-14	150	610	283	1 830	
5.00-15	TS-06	TT	3,00D×15 (4J×15)	5.00-15	129	661	307	1 985	
5.00-15	TS-06	TT	3,00D×15 (4J×15)	5.00-15	129	661	307	1 985	
6.5/90-15 (170/90-15)	TS-06	TT	5J×15 (41/2K×15)	6.5/80-15	163	695	318	2 040	
6.5/90-15 (170/90-15)	TS-06	TT	5J×15 (41/2K×15)	6.5/80-15	163	695	318	2 040	
6.5/90-15 (170/90-15)	TS-06	TT	5J×15 (41/2K×15)	6.5/80-15	163	695	318	2 040	
690×180-15	TS-07	TT	5J×15		176	690	309	2 056	
10.0/75-15.3	TS-05	TL	9.00×15.3	10-15 HS 10/75-15	264	780	360	2 295	



	Ply rating PR	Service description LI/SS	Tyre load capacity (kg) – free rolling / drive wheel – at speed (km/h)					Tyre pressure (bar)
			10	20	25	30	40	
4 PR	79/68 A8	365 / 265	330 / 235	310 / 225	290 / 210	260 / 188	0.80	
		400 / 285	360 / 255	340 / 240	315 / 225	285 / 202	1.00	
		430 / 305	385 / 275	365 / 260	345 / 245	307 / 218	1.20	
		475 / 345	430 / 310	405 / 290	375 / 275	340 / 245	1.50	
		555 / 405	500 / 365	470 / 345	440 / 325	395 / 288	2.00	
		610 / 440	550 / 395	520 / 375	500 / 355	437 / 315	2.40	
6 PR	89/76 A8	695 / 475	625 / 425	590 / 400	550 / 380	495 / 338	2.75	
		730 / 505	655 / 455	620 / 430	580 / 405	520 / 362	3.00	
		810 / 560	730 / 505	690 / 475	650 / 450	580 / 400	3.50	
4 PR	72 A6	- / 458	- / 405	- / 380	- / 355		2.40	
8 PR		- / 820	- / 725	- / 680	- / 635		1.00	
		- / 1 160	- / 1 025	- / 965	- / 900		1.80	
		- / 1 380	- / 1 220	- / 1 145	- / 1 070		2.50	
		- / 1 445	- / 1 275	- / 1 200	- / 1 120		2.80	
		- / 1 640	- / 1 450	- / 1 355	- / 1 270		3.40	
4 PR	72/60 A6	335 / 235	295 / 215	280 / 195	260 / 185	235 / 170	1.00	
		425 / 300	375 / 265	355 / 250	330 / 230	295 / 210	1.50	
		460 / 325	405 / 285	380 / 270	355 / 250	320 / 225	1.70	
4 PR	75/63 A8	396 / 270	357 / 243	337 / 230	315 / 218	283 / 193	1.25	
		434 / 300	391 / 270	369 / 255	344 / 241	310 / 214	1.50	
		507 / 357	456 / 321	431 / 303	402 / 288	362 / 255	2.00	
		542 / 381	488 / 343	461 / 324	425 / 307	387 / 272	2.20	
6 PR	84/71 A8	578 / 405	520 / 364	491 / 344	456 / 325	413 / 289	2.50	
		638 / 444	575 / 399	543 / 377	508 / 356	456 / 317	3.00	
		700 / 483	630 / 435	595 / 411	560 / 387	500 / 345	3.50	
4 PR	86/75 A8	435 / 310	390 / 280	370 / 265	345 / 250	310 / 222	0.80	
		475 / 335	430 / 300	405 / 285	375 / 270	340 / 239	1.00	
		495 / 350	445 / 315	420 / 300	400 / 280	355 / 250	1.20	
		600 / 435	540 / 395	510 / 370	475 / 350	430 / 312	1.50	
		650 / 475	585 / 425	555 / 400	515 / 380	465 / 338	1.80	
		705 / 515	635 / 460	600 / 435	560 / 410	505 / 367	2.10	
		740 / 540	670 / 485	630 / 460	600 / 430	530 / 385	2.40	
6 PR	94/82 A8	790 / 560	710 / 505	670 / 475	630 / 450	565 / 401	2.70	
		840 / 595	755 / 535	715 / 505	670 / 475	600 / 425	3.00	
		890 / 630	800 / 565	755 / 535	710 / 505	635 / 450	3.30	
		940 / 665	845 / 600	795 / 565	750 / 530	670 / 475	3.60	
8 PR	100/88 A8	1 010 / 710	910 / 640	860 / 600	810 / 565	720 / 505	4.00	
		1 065 / 740	960 / 670	905 / 630	850 / 595	760 / 530	4.40	
		1 120 / 785	1 010 / 705	950 / 670	895 / 630	800 / 560	4.80	
4 PR	100/88 A8	1 030 / 720	925 / 650	875 / 615	825 / 575	735 / 515	2.00	
		1 120 / 785	1 010 / 705	950 / 665	890 / 625	800 / 560	2.50	
8 PR	118/106 A8	1 665 / 1 210	1 500 / 1 090	1 415 / 1 030	1 335 / 970	1 190 / 865	2.50	
		1 850 / 1 330	1 665 / 1 195	1 570 / 1 130	1 480 / 1 065	1 320 / 950	3.00	

Tractor Small Tyres (continued)

Technical data and load capacities

Tyre size	Tread pattern	Type	Rim (permitted)	Tube	Section width (mm)	Overall diameter (mm)	Loaded static radius (mm)	Rolling circumference (mm)	
10.0/75 - 15.3	TS-05	TL	9.00×15.3	10 - 15 HS 10/75 - 15	264	780	360	2 295	
11.5/80 - 15.3	TS-05	TL	9.00×15.3	11.5/80 - 15	290	867	410	2 550	
11.5/80 - 15.3	TS-05	TL	9.00×15.3	11.5/80 - 15	290	867	410	2 550	
6.00 - 16	TS-04	TT	4.50E×16 (4.00E×16)	6.00 - 16	169	735	345	2 160	
6.00 - 16	TS-04	TT	4.50E×16 (4.00E×16)	6.00 - 16	169	735	345	2 160	
6.00 - 16	TD-13	TT	4.50E×16 (4.00E×16)	6.00 - 16	169	735	345	2 160	
6.50 - 16	TD-10	TL	4.50E×16 (4.00E) (5.00F)	—	179 174 184	773	360	2 280	
7.50 - 16	TS-04	TT/TL	5.50F×16 (5.00F, 6.00F)	7.50 - 16	205	803	375	2 360	
7.50 - 16	TS-04	TT/TL	5.50F×16 (5.00F, 6.00F)	7.50 - 16	205	803	375	2 360	
7.50 - 16	TD-13	TT	5.50F×16 (5.00F, 6.00F)	7.50 - 16	205	803	375	2 360	
7.50 - 20	TS-04	TT	5.50F×20 (6.00F×20)	7.50 - 20	205	904	420	2 660	
7.50 - 20	TD-13	TT	5.50F×20 (6.00F×20)	7.50 - 20	205	904	420	2 660	
8.3 - 20	TD-13	TT	W7×20 (W6×20)	8.3 - 20	211	895	416	2 640	

For Non-standard version, please contact a producer. ¹⁾ Reinforced version also available (REINFORCED)



	Ply rating PR	Service description L/SS	Tyre load capacity (kg) – free rolling / drive wheel – at speed (km/h)					Tyre pressure (bar)
			10	20	25	30	40	
10 PR	122/111 A8	1 910 / 1 380	1 720 / 1 240	1 625 / 1 170	1 530 / 1 105	1 365 / 985	3.25	
		1 975 / 1 430	1 775 / 1 285	1 680 / 1 215	1 580 / 1 140	1 410 / 1 020	3.50	
		2 100 / 1 525	1 890 / 1 375	1 785 / 1 295	1 680 / 1 220	1 500 / 1 090	4.00	
10 PR	130/119 A8	1 820 / 1 510	1 640 / 1 360	1 545 / 1 285	1 455 / 1 210	1 300 / 1 080	2.25	
		2 065 / 1 580	1 860 / 1 425	1 755 / 1 345	1 650 / 1 265	1 475 / 1 130	2.50	
		2 430 / 1 735	2 185 / 1 560	2 065 / 1 475	1 945 / 1 390	1 735 / 1 240	3.00	
		2 660 / 1 905	2 395 / 1 715	2 260 / 1 620	2 130 / 1 525	1 900 / 1 360	3.50	
14 PR	139/126 A8	2 970 / 2 170	2 670 / 1 955	2 525 / 1 845	2 375 / 1 735	2 120 / 1 550	4.00	
		3 260 / 2 310	2 935 / 2 080	2 775 / 1 965	2 610 / 1 850	2 330 / 1 650	4.50	
		3 400 / 2 380	3 060 / 2 140	2 890 / 2 035	2 720 / 1 905	2 430 / 1 700	4.75	
6 PR	91/79 A8	625 / 440	560 / 395	530 / 375	500 / 350	445 / 315	1.50	
		730 / 520	655 / 465	620 / 440	580 / 410	520 / 370	2.00	
		820 / 580	735 / 525	695 / 495	655 / 460	585 / 415	2.50	
		860 / 610	775 / 550	730 / 520	690 / 490	615 / 437	2.75	
8 PR	100/88 A8	930 / 650	840 / 585	790 / 555	745 / 515	665 / 465	3.00	
		1 030 / 720	925 / 650	875 / 615	825 / 570	735 / 515	3.50	
		1 120 / 785	1 010 / 705	950 / 665	895 / 615	800 / 560	4.00	
6 PR	79 A8	- / 450	- / 395	- / 375	- / 350	- / 315	1.50	
		- / 530	- / 465	- / 440	- / 410	- / 370	2.00	
		- / 595	- / 525	- / 495	- / 460	- / 410	2.50	
		- / 630	- / 550	- / 520	- / 490	- / 440	2.80	
8 PR	99A8	- / 660	- / 625	- / 585	- / 545	- / 510	1.60	
		- / 850	- / 800	- / 750	- / 700	- / 655	2.40	
		- / 1 010	- / 955	- / 890	- / 830	- / 775	3.20	
6 PR	100/88 A8	905 / 630	815 / 565	770 / 535	720 / 500	645 / 450	1.50	
		1 065 / 740	960 / 665	905 / 630	850 / 585	760 / 525	2.00	
		1 120 / 785	1 010 / 705	950 / 665	895 / 630	800 / 560	2.25	
8 PR ¹⁾	108/95 A8	1 220 / 840	1 095 / 755	1 035 / 715	975 / 665	870 / 600	2.50	
		1 360 / 935	1 220 / 840	1 155 / 795	1 085 / 740	970 / 665	3.00	
		1 400 / 965	1 260 / 870	1 190 / 820	1 120 / 775	1 000 / 690	3.25	
6 PR	100/88 A8	905 / 630	815 / 565	770 / 535	720 / 500	645 / 450	1.50	
		1 065 / 740	960 / 665	905 / 630	850 / 585	760 / 525	2.00	
		1 120 / 785	1 010 / 705	950 / 665	895 / 630	800 / 560	2.25	
6 PR	103/91 A8	985 / 690	890 / 620	840 / 585	790 / 545	705 / 490	1.50	
		1 155 / 810	1 040 / 730	980 / 690	925 / 640	825 / 575	2.00	
		1 225 / 680	1 105 / 775	1 040 / 730	980 / 690	875 / 615	2.25	
6 PR	103/91 A8	985 / 690	890 / 620	840 / 585	790 / 545	705 / 490	1.50	
		1 155 / 810	1 040 / 730	980 / 690	925 / 640	825 / 575	2.00	
		1 225 / 680	1 105 / 775	1 040 / 730	980 / 690	875 / 615	2.25	
6 PR	104/92 A8	915 / 530	810 / 465	760 / 440	710 / 410	630 / 370	0.80	
		1 045 / 660	925 / 580	865 / 545	810 / 510	720 / 460	1.20	
		1 175 / 785	1 035 / 695	975 / 655	910 / 610	810 / 550	1.60	
		1 305 / 915	1 150 / 810	1 080 / 760	1 010 / 710	900 / 630	2.00	

These tyres are for normal agricultural use and not for continuous highway service.



TF-01

Multi-rib tread profile without any lateral tread elements and side lugs.



TF-02

Multi-rib tread pattern with short, strong shoulder lugs. Secure track holding and good climbing capabilities when steering out of the furrow.



TF-03

Multi-rib tread pattern with very strong shoulder lugs and lateral tread elements.



TF-04

Pattern with high stability in track due to deep relief of design.



TF-05

Designed for non-driven tractor wheels. Improved on-road performance and straight-line steering characteristics.



TF-06

Pattern with very long service life and excellent steering characteristics, mainly on soft terrain.

Tractor front tyres with balanced properties

For perfect handling on and off the road



IM-05

Special tread pattern developed for steering wheels of industrial tractors.

Tyre size	TF-01	TF-02	TF-03	TF-04	TF-05	TF-06	IM-05
4.00-16		•					
4.50-16		•					
5.00-16		•					
6.00-16	•	•	•			•	
6.50-16		•	•		•		
7.50-16	•	•	•		•		
9.00-16			•				
10.00-16			•				
11L-16							•
6.00-18			•	•			
6.50-20			•	•	•		
7.50-20	•		•		•		

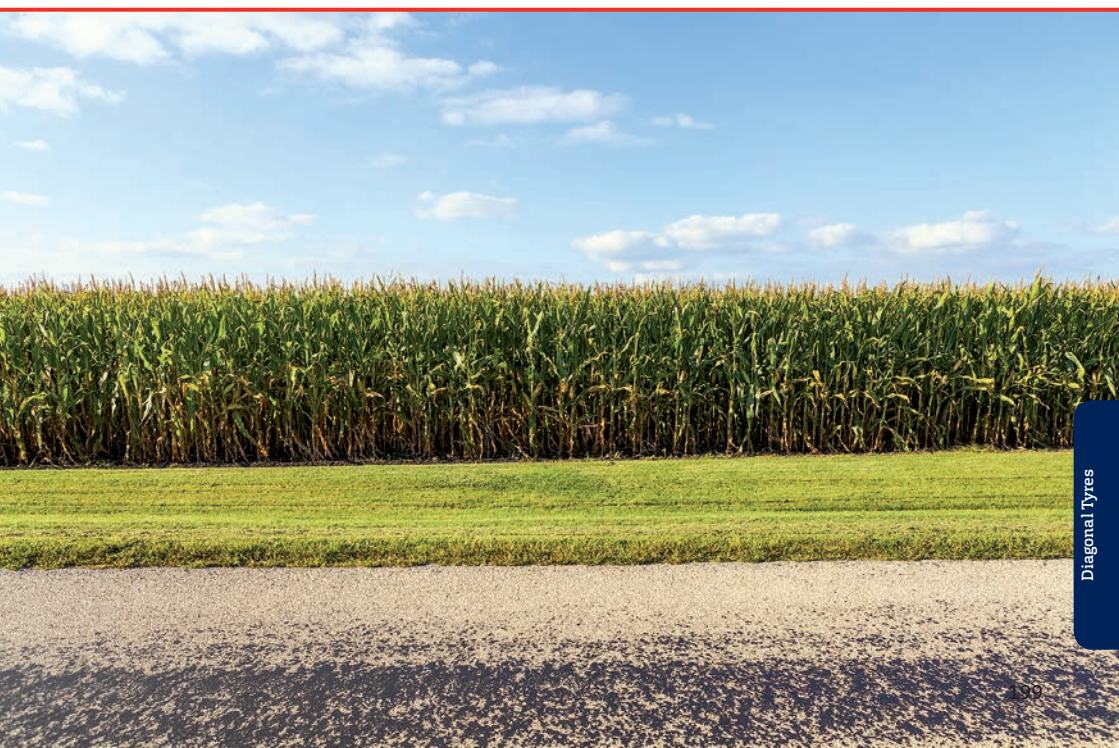

Tractor Front Tyres

Technical data and load capacities

Tyre size	Tread pattern	Type	Rim (permitted)	Tube	Section width (mm)	Overall diameter (mm)	Loaded static radius (mm)	Rolling circumference (mm)	
4.00-16	TF-02	TT	3.00D×16	3.00-16	118	645	306	1 896	
4.50-16	TF-02	TT	3.00D×16	3.00-16	121	657	308	1 932	
5.00-16	TF-02	TT	3.50D×16 (4.00E×16)	3.50-16	138 143	679	318	1 996	
6.00-16	TF-01	TT	4.50E×16 (4.00E, 5K, 5.00F)	6.00-16	165	735	340	2 160	
6.00-16	TF-02	TT	4.50E×16 (4.00E,5K,5.00F)	6.00-16	169	739	344	2 173	
6.00-16	TF-03	TT	4.50E×16 (4.00E, 5K, 5.00F)	6.00-16	165	735	340	2 160	
6.00-16	TF-06	TT	4.50E×16 (4.00E, 5K, 5.00F)	6.00-16	165	735	340	2 160	
6.50-16	TF-02	TT	4.50E×16 (4.00E, 5K, 5.00F, 5.50F)	6.50-16	183	765	356	2 241	



Ply rating PR	Service description LI/SS	Tyre load capacity (kg) at speed (km/h)				Tyre pressure (bar)
		10 *	20	30	40	
4 PR	69 A6 (61 A8)	240	215	160	130	1.00
		350	320	235	190	2.00
		400	360	265	210	2.50
		490	440	325	260	3.40
4 PR	73 A6 (65 A8)	255	255	190	150	1.00
		385	385	285	230	2.00
		490	440	325	260	2.50
		550	490	365	290	3.10
4 PR	75 A6 (67 A8)	320	290	215	170	1.00
		405	365	270	215	1.50
		480	430	320	255	2.00
		580	520	387	310	2.80
6 PR	88 A6 (80 A8)	445	400	295	235	1.00
		535	480	355	285	1.50
		630	565	420	335	2.00
		720	650	480	385	2.50
		805	720	535	430	3.00
		840	755	560	450	3.30
6 PR	88 A6 (80 A8)	445	400	295	235	1.00
		535	480	355	285	1.50
		630	565	420	335	2.00
		720	650	480	385	2.50
		805	720	535	430	3.00
		840	755	560	450	3.30
6 PR	88 A6 (80 A8)	445	400	295	235	1.00
		535	480	355	285	1.50
		630	565	420	335	2.00
		720	650	480	385	2.50
		805	720	535	430	3.00
		840	755	560	450	3.30
6 PR	91 A6 (83 A8)	475	425	315	250	1.00
		580	520	385	310	1.50
		685	615	455	365	2.00
		790	710	525	420	2.50
		900	810	600	480	3.00
		925	830	615	485	3.20

Tractor Front Tyres (continued)

Technical data and load capacities

Tyre size	Tread pattern	Type	Rim (permitted)	Tube	Section width (mm)	Overall diameter (mm)	Loaded static radius (mm)	Rolling circumference (mm)	
6.50-16	TF-03	TT	4.50E×16 (4.00E, 5K, 5.00F, 5.50F)	6.50-16	175	760	350	2 230	
6.50-16	TF-03	TT	4.50E×16 (4.00E, 5K, 5.00F, 5.50F)	6.50-16	175	760	350	2 230	
6.50-16	TF-05	TT	4.50E×16 (4.00E, 5K, 5.00F, 5.50F)	6.50-16	175	760	350	2 230	
7.50-16	TF-01	TT	5.50F×16 (5.00F, 6.00F)	7.50-16	205	805	370	2 365	
7.50-16	TF-02	TT	5.50F×16 (5.00F, 6.00F)	7.50-16	218	820	383	2 398	
7.50-16	TF-02	TT	5.50F×16 (5.00F, 6.00F)	7.50-16	218	820	383	2 398	
7.50-16	TF-03	TT	5.50F×16 (5.00F, 6.00F)	7.50-16	205	805	370	2 365	
7.50-16	TF-03	TT	5.50F×16 (5.00F, 6.00F)	7.50-16	205	805	370	2 365	
7.50-16	TF-05	TT	5.50F×16 (5.00F, 6.00F)	7.50-16	205	805	370	2 365	
9.00-16	TF-03	TT	W8×16 (6.00F, W7, W8L)	9.00-16	234	855	395	2 514	



Ply rating PR	Service description LI/SS	Tyre load capacity (kg) at speed (km/h)				Tyre pressure (bar)
		10 *	20	30	40	
6 PR	91 A6 (83 A8)	475	425	315	250	1.00
		580	520	385	310	1.50
		685	615	455	365	2.00
		790	710	525	420	2.50
		900	810	600	480	3.00
		925	830	615	485	3.20
8 PR	97 A6 (89 A8)	1 065	960	710	560	4.00
		1 095	985	730	580	4.20
6 PR	91 A6 (83 A8)	475	425	315	250	1.00
		580	520	385	310	1.50
		685	615	455	365	2.00
		790	710	525	420	2.50
		900	810	600	480	3.00
		925	830	615	485	3.20
6 PR	98 A6 (90 A8)	780	700	520	415	1.50
		925	830	615	490	2.00
		1 050	945	700	560	2.50
		1 125	1 015	750	600	2.80
6 PR	98 A6 (90 A8)	780	700	520	415	1.50
		925	830	615	490	2.00
		1 050	945	700	560	2.50
		1 125	1 015	750	600	2.80
8 PR	103 A6 (96 A8)	1 160	1 045	775	620	3.10
		1 210	1 090	805	645	3.30
		1 260	1 135	840	670	3.50
		1 315	1 180	875	710	3.70
6 PR	98 A6 (90 A8)	780	700	520	415	1.50
		925	830	615	490	2.00
		1 050	945	700	560	2.50
		1 125	1 015	750	600	2.80
8 PR	103 A6 (96 A8)	1 160	1 045	775	620	3.10
		1 210	1 090	805	645	3.30
		1 260	1 135	840	670	3.50
		1 315	1 180	875	710	3.70
6 PR	98 A6 (90 A8)	780	700	520	415	1.50
		925	830	615	490	2.00
		1 050	945	700	560	2.50
		1 125	1 015	750	600	2.80
6 PR	104 A6 (97 A8)	835	750	555	445	1.00
		1 035	930	690	550	1.50
		1 245	1 120	830	665	2.00
		1 350	1 215	900	730	2.30

Tractor Front Tyres (continued)

Technical data and load capacities

Tyre size	Tread pattern	Type	Rim (permitted)	Tube	Section width (mm)	Overall diameter (mm)	Loaded static radius (mm)	Rolling circumference (mm)	
9.00-16	TF-03	TT	W8×16 (6.00F, W7, W8L)	9.00-16	234	855	395	2 514	
10.00-16	TF-03	TT/TL	W8×16 (W8L×16)	9.00-16 10.00-16	274	895	411	2 630	
11L-16	IM-05 (F3)	TL	W8×16	—	285	825	372	2 365	
6.00-18	TF-03	TT	4.50E×18 (4.00E, 5K, 5.00F)	6.00-18	160	790	365	2 323	
6.00-18	TF-04	TT	4.50E×18 (4.00E, 5K, 5.00F)	6.00-18	160	790	365	2 323	
6.50-20	TF-03	TT	5.00F×20 (4.00E, 5.50F)	6.50-20 7.00-20	175	865	408	2 543	
6.50-20	TF-04	TT	5.00F×20 (4.00E, 5.50F)	6.50-20 7.00-20	175	865	408	2 543	
6.50-20	TF-05	TT	5.00F×20 (4.00E, 5.50F)	6.50-20 7.00-20	175	865	408	2 543	
7.50-20	TF-01	TT	5.50F×20 (5.00F, 6.00F)	7.50-20	205	915	420	2 690	
7.50-20	TF-03	TT	5.50F×20 (5.00F, 6.00F)	7.50-20	205	915	420	2 690	



	Ply rating PR	Service description LI/SS	Tyre load capacity (kg) at speed (km/h)				Tyre pressure (bar)
			10 *	20	30	40	
8 PR	111 A6 (103 A8)	1 450	1 300	965	770	2.50	
		1 510	1 355	1 005	805	2.70	
		1 570	1 410	1 045	835	2.90	
		1 635	1 470	1 090	875	3.10	
8 PR	118 A6 (114 A8)	1 075	895	715	645	1.00	
		1 335	1 110	890	800	1.50	
		1 585	1 320	1 055	950	2.00	
		1 835	1 530	1 220	1 100	2.50	
		1 970	1 640	1 310	1 180	2.80	
10 PR	119 A6 (115 A8)	1 150	1 035	920	820	2.00	
		1 365	1 230	1 090	975	2.50	
		1 520	1 365	1 215	1 085	3.00	
		1 660	1 495	1 325	1 185	3.50	
		1 700	1 530	1 360	1 215	3.75	
6 PR	96 A6 (88 A8)	705	635	470	375	2.00	
		855	770	570	455	2.50	
		1 005	905	670	535	3.00	
		1 065	960	710	560	3.20	
6 PR	96 A6 (88 A8)	705	635	470	375	2.00	
		855	770	570	455	2.50	
		1 005	905	670	535	3.00	
		1 065	960	710	560	3.20	
6 PR	97 A6 (89 A8)	795	715	530	425	2.00	
		930	835	620	495	2.50	
		1 060	950	705	565	3.00	
		1 095	985	730	580	3.20	
6 PR	97 A6 (89 A8)	795	715	530	425	2.00	
		930	835	620	495	2.50	
		1 060	950	705	565	3.00	
		1 095	985	730	580	3.20	
6 PR	97 A6 (89 A8)	795	715	530	425	2.00	
		930	835	620	495	2.50	
		1 060	950	705	565	3.00	
		1 095	985	730	580	3.20	
6 PR	103 A6 (96 A8)	880	790	585	470	1.50	
		1 050	945	700	560	2.00	
		1 215	1 095	810	650	2.50	
		1 315	1 180	875	700	2.80	
6 PR	103 A6 (96 A8)	880	790	585	470	1.50	
		1 050	945	700	560	2.00	
		1 215	1 095	810	650	2.50	
		1 315	1 180	875	700	2.80	

Tractor Front Tyres (continued)

Technical data and load capacities

Tyre size	Tread pattern	Type	Rim (permitted)	Tube	Section width (mm)	Overall diameter (mm)	Loaded static radius (mm)	Rolling circumference (mm)	
7.50-20	TF-05	TT	5.50F×20 (5.00F, 6.00F)	7.50-20	205	915	420	2 690	

* Basic Inflation Pressure must be increased about 25%.

For Non-standard version, please contact a producer.

These tyres are for normal agricultural use and not for continuous highway service.



Ply rating PR	Service description LI/SS	Tyre load capacity (kg) at speed (km/h)				Tyre pressure (bar)
		10 *	20	30	40	
6 PR	103 A6 (96 A8)	880	790	585	470	1.50
		1 050	945	700	560	2.00
		1 215	1 095	810	650	2.50
		1 315	1 180	875	700	2.80



B 2



B 5



B 6



B 11



B 15



V-5501



V-5501A

Bantam tyres

For light agricultural equipment and hand trucks

Tyre size	Tread pattern	Ply rating PR	Service description LI/SS	Type	Rim (permitted)	Tube Flap	Section width (mm)	Overall diameter (mm)	Tyre load capacity (kg)	Tyre pressure (bar)	Speed (km/h)
3.50-6	B 15	4 PR	45 A6	TT	2.50×6	4.00-6	96	343	165	3.00	30
3.50-6	B 15 Ribbed	4 PR	49 A6	TT	2.50×6	4.00-6	100	343	185	2.50	30
4.00-6	V-5501	2 PR	42 A6	TT	3.00×6	4.00-6	114	374	150	2.10	30
4.00-6	V-5501	4 PR	54 A6	TT	3.00×6	4.00-6	114	374	212	2.50	30
4.00-6	V-5501	6 PR	63 A6	TT	3.00×6	4.00-6	114	374	272	3.50	30
4.00-6	B 11	6 PR	59 A6	TT	2.50×6	3.50/4.00-6	109	367	243	4.25	30
3.50-8	B 6	2 PR	42 A4	TT	2.50×8	3.50-8	100	393	150	2.00	20
3.50-8	B 11	4 PR	49 A6	TT	2.50×8	3.50/4.00-8	98	400	185	3.00	30
3.50-8	B 15	4 PR	49 A6	TT	2.50×6	3.50/4.00-8	96	388	185	3.00	30
3.50-8	V-5501	2 PR	42 A6	TT	2.50×8	3.50/4.00-8	100	393	150	2.10	30
3.50-8	V-5501	4 PR	48 A6	TT	2.50×8	3.50/4.00-8	100	393	180	2.50	30
16×4	B 2	4 PR	71 A2	TT	2.50A×8	16×4	114	415	345	3.50	10
16×4	B 5	4 PR	71 A2	TT	2.50A×8	16×4	114	415	345	3.50	10
4.00-8	V-5501B	2 PR	45 A6	TT	3.00×8	3.50/4.00-8	112	418	165	2.10	30
4.00-8	V-5501A	4 PR	55 A6	TT	3.00×8	3.50/4.00-8	112	418	218	2.50	30
4.00-8	B 11	4 PR	57 A6	TT	3.00×8	3.50/4.00-8	109	410	230	2.75	30

These tyres are for normal agricultural use and not for continuous highway service.



Tread pattern marking – United States

Production name	United States Marking
Tractor Radial Tyres	
HC 1000	R-1
HC 2000	R-1W
HC 3000	R-1W
SFT	R-1W
SST	R-1W
AC 65	R-1W
HC 70	R-1W
AC 70 T	R-1W
AC 70 G	R-1
AC 70 H	R-1W
AC 85	R-1W
AC 85 Row Crop	R-1W
AC 90 Row Crop	R-1
TF	
TF-01	F-2
TF-03	F-2
TF-04	F-2
TF-05	F-2
TF-06	F-2
IM-05	F-3
AR	
AR-01	I-3 / HF-2
AR-02	I-3 / HF-2
AR-03	I-3 / HF-2
AR-04	I-3 / HF-2
AR-05	I-3 / HF-2
AGRITERRA 02	I-3 / HF-2
AGRITERRA 03	I-3 / HF-3
AGRITERRA 04	I-3 / HF-2
Tractor Diagonal Tyres	
TD	
TD-01	R-1
TD-02	R-1
TD-03	R-1
TD-05	R-1
TD-10	R-1

Production name	United States Marking
TD-13	R-1
TD-17	R-1
TD-19	R-1
AF	
AF-01	R-1
TL-01	R-1
IM	
IM-01	I-3
IM-02	I-3
IM-03	I-1
IM-04	I-1
IM-06	I-1
IM-07	I-1
IM-08	I-1
IM-09	I-2
IM-10	I-1
TR	
TR-01	R-1
TR-03	R-4
TR-04	R-4
TR-05	R-4
TR-06	I-3
TR-07	I-3
TR-08	I-3 / HF-2
TR-09	R-4
TR-10	R-4
TR-11	R-4
TR-12	R-4
TS	
TS-01	R-1
TS-02	R-1
TS-03	R-1
TS-04	R-1
TS-05	R-1
TS-06	R-1
TS-07	R-1

Use and Maintenance

Storage

- > Keep the tyres clean and away from heat, light, ozone or hydrocarbon sources.
- > Avoid prolonged exposure of the tyres to direct sunlight.
- > Avoid any contact with grease, petrol, volatile solvents or other substances that may deteriorate the rubber.
- > Avoid horizontal storage for tubeless tyres, only small size tyres may be stacked or stored flat (maximum 6 months).
- > When tyres are stored flat (horizontal), the position must be lug against lug.
- > Reduce inflation pressure when tyres are stored fitted on rims.
- > Ensure there is no water or moisture inside the tyre.
- > Never store tyres directly in contact with the ground for long periods.

Tyre repairs

- > For safety reasons, repairs should only be carried out by specialists using the correct tools.

Proper use of tyres

- > When loading tyres you have to consider the correlation between speed, inflation pressure and load capacity.
- > Overloading results in premature tyre failure. Use the technical documentation and inflation tables which show the load and pressure figures for different operating speeds.
- > Underinflation results not only in incorrect tread wear but also in ply separation and eventually further damage to the ply.
- > Overinflation makes the tyre stiff and decreases its resistance against hits, leading to ply tear.



Check inflation pressure regularly.



Avoid contact with grease, oil and other chemicals.



Inspect tyres for damage and irregularities.



Observe tyre and vehicle load limits.



Read safety and maintenance recommendations.



Use only authorised repair.

Fitting and removal instructions

Demounting and mounting procedures can be dangerous, and should be performed only by trained and qualified staff, using proper tools and procedures. Failure to comply with these procedures may result in faulty positioning of the tyre on the rim, and cause the tyre to burst with explosive force leading to serious physical injury or death.

Fitting

1. Make sure that the rim, the tyre and the tube are compatible.
2. Check that the tyre is suitable for the machine. Use only rims recommended or permitted by the tyre manufacturer.
3. Always use the proper specialised equipment and tools.
4. The rim must be clean and in perfect condition (no damage, etc.). If necessary, clean the rim thoroughly with a wire brush. Never fit a tyre onto a rim that shows cracks, significant distortion, evidence of welded repair, etc.
5. Thoroughly inspect the inside as well as the outside of the tyre in order to identify any damage which may be present. If the damage is considered to be beyond repair, the tyre should be scrapped.
6. If fitting with a tube, always use the correct new tube and flap for the tyre size. For fitting tubeless tyres without tubes, on tubeless rims, always use a new tubeless valve.
7. Before fitting, lubricate the rim and the beads. Use only a suitable lubricant that will not damage the tyre (never use silicone or petroleum-based products).
8. We recommend vertical fitting. In case of horizontal fitting it is impossible to see if the lower bead is correctly seated.
9. Fit the tyre on the rim diametrically opposite to the valve hole (respect, if present, the rotation direction indicated by the arrows). With the help of a suitable lever and closely repeated applications, get the first bead over the rim flange. Then pose the lightly inflated talc coated tube (if fitted) inside the tyre. Locate the valve, fitting the ferrule loosely. Fit the second bead, lever it progressively over the rim flange, finish at the valve.
10. For seating the beads and centring of the tyre, remove the valve core. Slowly inflate to ensure correct seating of the beads. Ensure that the beads do not pinch the tube.
11. During tyre inflation keep at a safe distance and always use a safety cage. If possible, fasten the tyre to the wall or use retaining chains. During pressure readings ensure that no part of the body is within the possible trajectory of the valve mechanism or of the caps. It is recommended to use suitable pressure limitation gauges. Use a filter and dehumidifier on the compressed air line to avoid introducing humidity or dirt. Never use a hammer to make a tyre bead seat by hitting it.
12. Continue inflation. Make sure that you do not inflate beyond 2.5 bar if the beads are not well seated and centred on the wheel.
13. If the beads are not correctly seated, deflate, lubricate and inflate again. Repeat these operations until the beads are correctly seated.
14. When all the previous operations have been correctly done refit the valve core. Set the pressure according to the load – see tables in technical databook.
15. Make sure the valves do not touch the rims, the brake drums or other fixed mechanical parts.

Removing

- > Never try to unseat the beads of an inflated tyre.
- > Always remove the valve core.
- > Let the tyre deflate, check before unseating that the tyre is completely deflated. Never use tools that could damage the rims or the beads of the tyre.

Liquid ballasting of tractor tyres

In some cases, it is necessary to add weight to tyres to increase traction power. Filling the tyre with a liquid (water) is a simple and inexpensive way. It is possible to add liquid to the tyres up to 75% of their volume. In winter, to avoid the water damaging the tyres when it freezes, suitable quantities of anti-freeze must be added.

Instructions for adding liquid

1. Jack the wheel up and position the valve at the highest vertical point.
2. Unscrew the removable valve body from the valve and connect a combined air-water fill and draining valve to the valve chunk. Air can be removed from the tyre through this valve while the water is entering.
3. Introduce the water or anti-freeze mixture into the tyre. Stop filling when liquid starts to issue from the valve. The quantity of liquid added will be about 75%. Do not over-fill!
4. Replace the valve body and inflate the tyre to the recommended operating pressure.
5. Clean all metal parts – anti-freeze solution is corrosive.

Instructions for draining liquid

1. Jack the wheel up and position the valve at the lowest vertical point.
2. Unscrew the valve core and let the water drain out.
3. Attach a small rubber hose of suitable length to the locking washer and insert the hose into the tyre tube, then screw the washer down over the stem of the valve.
4. Inflate the tyre with air.
5. Remove the internal valve stem and let the remaining water drain from the tyre.
6. Remove the rubber hose and reassemble the valve. Inflate with air up to the recommended pressure.

Anti-freeze solution

- > As protection against frost, it is recommended to add Calcium Chloride (CaCl_2). If a tubeless tyre is mounted, we recommend that the rim should be treated against corrosion or an inner tube must be used.
- > Remember – prepare the solution by pouring the Calcium Chloride into the water, stirring to help it dissolve. Never pour water on to Calcium Chloride, it is dangerous.

CaCl_2 per litre of water	Protection to
200 g	-10 °C
250 g	-15 °C
300 g	-20 °C
350 g	-25 °C
400 g	-30 °C

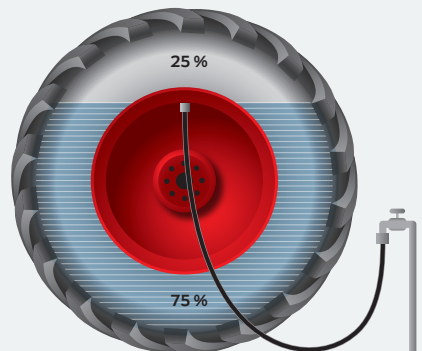

Liquid ballasting of tractor tyres

Quantity when approx. 75 % full

Inch	Tyre size (Alternative Tyre size)	Tread pattern	Liquid (l)
16"	200/70 R 16	AC 70 T	35
	240/70 R 16	AC 70 T	40
	260/70 R 16	AC 70 T	45
	265/70 R 16 MPT	AC 70 G	45
	280/70 R 16	AC 70 T	50
	285/80 R 16 MPT	AC 70 G	60
	320/65 R 16	AC 65	65
17"	425/55 R 17 MPT	AC 70 G	95
18"	280/70 R 18	AC 70 T	55
	325/70 R 18 MPT	AC 70 G	82
	365/70 R 18 MPT	AC 70 G	105
20"	260/70 R 20	AC 70 T	52
	275/80 R 20 MPT	AC 70 G	65
	280/70 R 20	AC 70 T	60
	280/85 R 20 (11.2 R 20)	AC 85	65
	300/70 R 20	AC 70 T	70
	320/70 R 20	AC 70 T	80
	335/80 R 20 MPT	AC 70 G	105
	360/70 R 20	AC 70 T	115
	375/70 R 20 MPT	AC 70 G	120
	380/70 R 20	AC 70 T	120
	405/70 R 20 MPT	AC 70 G	140
	420/65 R 20	AC 65	145
	425/75 R 20 MPT	AC 70 G	150
22.5"	445/65 R 22.5 MPT	AC 70 +	170
24"	280/85 R 24 (11.2 R 24)	AC 85	85
	320/70 R 24	HC 70	100
	320/70 R 24	AC 70 T	100
	320/85 R 24 (12.4 R 24)	AC 85	115
	340/85 R 24 (13.6 R 24)	AC 85	140
	360/70 R 24	HC 70	125
	360/70 R 24	AC 70 T	125
	380/70 R 24	HC 70	145
	380/70 R 24	AC 70 T	145

Inch	Tyre size (Alternative Tyre size)	Tread pattern	Liquid (l)
24"	380/70 R 24	AC 70 G	145
	380/85 R 24 (14.9 R 24)	AC 85	185
	405/70 R 24 MPT	AC 70 G	155
	420/70 R 24	HC 70	170
	420/70 R 24	AC 70 T	170
	420/70 R 24	AC 70 G	170
	420/85 R 24 (16.9 R 24)	AC 85	240
	440/65 R 24	AC 65	185
	440/80 R 24 IND	HCM	230
	445/70 R 24 MPT	AC 70 G	205
	460/70 R 24 IMP	AC 70 G	220
	480/65 R 24	AC 65	210
	480/70 R 24	HC 70	225
	480/70 R 24	AC 70 G	225
	495/70 R 24 MPT	AC 70 G	240
	500/70 R 24 IMP	AC 70 G	245
	500/85 R 24 IMP	SFT	310
	540/65 R 24	AC 65	300
	25"	1000/50 R 25	SFT
26"	620/75 R 26	SFT	505
	750/65 R 26	SFT	600
28"	280/85 R 28 (11.2 R 28)	AC 85	100
	320/85 R 28 (12.4 R 28)	AC 85	130
	340/85 R 28 (13.6 R 28)	AC 85	160
	380/70 R 28	HC 70	165
	380/70 R 28	AC 70 T	165
	380/85 R 28 (14.9 R 28)	AC 85	205
	400/80 R 28 IND	HCM	205
	420/70 R 28	HC 70	200
	420/70 R 28	AC 70 T	200
	420/70 R 28	AC 70 G	200
	VF 420/85 R 28 (16.9 R 28)	HC 2000	250
420/85 R 28 (16.9 R 28)	AC 85	250	
440/65 R 28	AC 65	200	

Inch	Tyre size (Alternative Tyre size)	Tread pattern	Liquid (l)	
	440/70 R 28 IND	AC 70 G	215	
	440/80 R 28 IND	HCM	255	
	480/65 R 28	AC 65	250	
	480/70 R 28	HC 70	260	
	480/70 R 28	AC 70 T	260	
	500/80 R 28 IMP	SFT	350	
	540/65 R 28	SFT	315	
	540/65 R 28	AC 65	315	
	600/65 R 28	SFT	400	
	600/65 R 28	AC 65	400	
	600/65 R 28 IMP	AC 65	400	
	600/70 R 28	SFT	490	
	30"	380/85 R 30 (14.9 R 30)	AC 85	220
		420/70 R 30	HC 70	225
420/70 R 30		AC 70 T	225	
420/85 R 30 (16.9 R 30)		AC 85	270	
420/90 R 30		AC 85	285	
460/85 R 30 (18.4 R 30)		AC 85	340	
480/70 R 30		HC 70	275	
480/70 R 30		AC 70 T	275	
480/70 R 30		AC 70 G	275	
500/85 R 30 IMP		SFT	390	
VF 600/70 R 30		HC 2000	490	
540/65 R 30		SFT	330	
540/65 R 30		AC 65	330	
540/65 R 30 IMP		AC 65	330	
600/65 R 30		AC 65	430	
VF 600/70 R 30		HC 2000	490	
600/70 R 30		SFT	490	
620/70 R 30 IMP		SFT	495	
620/70 R 30 IMP		SFT N	495	
620/75 R 30		SFT	550	
620/75 R 30 IMP	SFT	550		
710/55 R 30	SFT	520		

Inch	Tyre size (Alternative Tyre size)	Tread pattern	Liquid (l)
	710/60 R 30	SFT	550
	710/60 R 30 IMP	SFT	550
	710/65 R 30 IMP	SFT	630
	750/55 R 30	SFT	500
32"	270/80 R 32	AC 90	100
	270/95 R 32	AC 85	115
	320/85 R 32 (12.4 R 32)	AC 85	140
	320/90 R 32	AC 85	150
	650/75 R 32	AC 70 N	700
	650/75 R 32	AC 75 G	700
	650/75 R 32	AC 70 G	700
	680/85 R 32 CHO	AC 70 G	950
	680/85 R 32	AC 70 G	950
	800/65 R 32	AC 70 H	900
	800/65 R 32	AC 70 N	900
	800/70 R 32 CHO	SFT	1000
	800/70 R 32	SFT	1000
	900/60 R 32 CHO	SFT	1030
	900/60 R 32	SFT	1030
	900/70 R 32 CHO	SFT	1200
900/70 R 32	SFT	1200	
1050/50 R 32	SFT	1280	
1250/50 R 32	SFT	1500	
34"	320/85 R 34	AC 85	205
	VF 380/85 R 34 (14.9 R 34)	HC 2000	240
	380/85 R 34 (14.9 R 34)	AC 85	240
	420/85 R 34 (16.9 R 34)	AC 85	290
	460/85 R 34 (18.4 R 34)	AC 85	380
	480/70 R 34	HC 70	310
	480/70 R 34	AC 70 T	310
	480/70 R 34	AC 70 G	310
	500/85 R 34 IMP	SFT	445
	520/70 R 34	HC 70	335
	520/70 R 34	AC 70 T	335

Liquid ballasting of tractor tyres (continued)

Quantity when approx. 75 % full

Inch	Tyre size (Alternative Tyre size)	Tread pattern	Liquid (l)
	520/70 R 34	AC 70 G	335
	540/65 R 34	AC 65	360
	600/65 R 34	AC 65	465
	650/60 R 34	SFT	540
	650/65 R 34	SFT	600
	710/60 R 34	SFT	660
36"	270/80 R 36	AC 90	115
38"	320/85 R 38 (12.4 R 38)	AC 85	205
	340/85 R 38 (13.6 R 38)	AC 85	215
	380/80 R 38 (14.9 R 38)	AC 85	240
	VF 380/95 R 38	HC 2000	280
	380/95 R 38	AC 85	280
	420/85 R 38 (16.9 R 38)	AC 85	320
	460/85 R 38 (18.4 R 38)	AC 85	420
	480/70 R 38	HC 70	340
	480/70 R 38	AC 70 T	340
	480/80 R 38 IND	HCM	385
	520/70 R 38	HC 70	395
	520/70 R 38	AC 70 T	395
	520/70 R 38	AC 70 G	395
	520/85 R 38 (20.8 R 38)	AC 85	530
	540/65 R 38	AC 65	420
	540/80 R 38 IND	HCM	505
	580/70 R 38	HC 70	550
	580/70 R 38	AC 70 T	550
	600/65 R 38	SST	500
	600/65 R 38	AC 65	500
650/65 R 38	SFT	630	
650/65 R 38	SST	630	
650/65 R 38	AC 65	630	
650/75 R 38	SFT	750	
650/85 R 38	SFT	900	
680/80 R 38 CHO	SFT	865	
710/70 R 38	SFT	800	

Inch	Tyre size (Alternative Tyre size)	Tread pattern	Liquid (l)
	710/70 R 38	AC 65	800
	800/70 R 38 CHO	SFT	1100
	800/70 R 38	SFT	1100
	900/60 R 38 CHO	SFT	1200
	900/60 R 38	SFT	1200
	42"	300/85 R 42 (11.2 R 42)	AC 90
300/95 R 42 (12.4 R 42)		AC 90	185
480/80 R 42		AC 85	460
VF 520/85 R 42		HC 2000	580
VF 520/85 R 42 CFO		HC 3000	580
520/85 R 42 (20.8 R 42)		AC 85	580
VF 580/85 R 42 CFO		HC 3000	645
580/85 R 42		SFT	645
VF 650/65 R 42		HC 2000	650
650/65 R 42		SST	650
650/65 R 42		AC 65	650
650/75 R 42		SFT	740
680/80 R 42 CHO		SFT	1020
680/80 R 42		SFT	1020
VF 710/70 R 42		HC 2000	880
VF 710/70 R 42 CFO		HC 3000	880
710/70 R 42		SFT	880
710/75 R 42		SFT	950
800/70 R 42 CHO		SFT	1135
900/60 R 42		SFT	1320
900/60 R 42 CHO	SFT	1320	
46"	320/95 R 46	AC 85	215
	VF 380/90 R 46	HC 1000	330
	380/90 R 46	AC 85	330
	VF 480/80 R 46	HC 2000	500
	480/80 R 46	AC 85	500
	520/85 R 46 (20.8 R 46)	AC 85	620
	710/65 R 46	SFT	925
	IF 710/65 R 46	SFT	925

Inch	Tyre size (Alternative Tyre size)	Tread pattern	Liquid (l)
48"	270/95 R 48	AC 90	150
	340/90 R 48 (13.6 R 48)	AC 85	230
50"	320/90 R 50	AC 85	245
	380/90 R 50	AC 85	360
	VF 380/105 R 50	HC 1000	395
	480/80 R 50	AC 85	550
	VF 480/95 R 50	HC 2000	650
	480/95 R 50	AC 85	650
	54"	320/90 R 54	AC 85
380/90 R 54		AC 85	345
VF 380/105 R 54		HC 2000	414
380/105 R 54		AC 85	414

Tyre size Diagonal tyres	Liquid (l)
8.3 - 20	45
8.3 - 24	50
9.5 - 24	60
11.2 - 24	70
12.4 - 24	80
13.6 - 24	120
14.9 - 24	150
16.9 - 24	210
18.4 - 26	305
23.1 - 26	470
11.2 - 28	90
12.4 - 28	110
13.6 - 28	140
14.9 - 28	180
16.9 - 28	220
16.9 - 30	240
18.4 - 30	320
9.5 - 32	80
12.4 - 32	140
16.9 - 34	250
18.4 - 34	330
12.4 - 36	150
12.4 - 38	170
13.6 - 38	190
14.9 - 38	220
15.5 - 38	245
16.9 - 38	280
18.4 - 38	370

Explanations referring to tractor tyres

Tables on page 24 to 105, 158 to 173 and 200 to 209

Load capacity and speed

When determining the minimum tyre size necessary for a vehicle, the approved axle load and the maximum design speed of the vehicle should always be used as the basis.

Nominal load capacity = 100 % load, as indicated by the Load Index (LI), see page 13.

In the case of twin-fitted driven wheels, a factor of 1.76 is applied to the load capacity of a single-fitted tyre.

Tyre pressure

The tyre pressures given in the tables are minimum tyre pressures and should be used as a guide only.

The given max. air pressures may not be exceeded. All tyre pressures refer to the "cold" tyre which has been standing outdoors for several hours, not exposed to intense sunlight.

For twin fitments of radial tyres on tractors (to minimise ground pressure) a min. tyre pressure of 0.4 bar is allowed.

The Static Loaded Radius is the distance between centre of wheel and paved ground measured at reference load and pressure.

The Rolling Circumference (at reference load and reference pressure) is the distance a tyre covers with one revolution on paved surface. Measurement acc. to ISO 11795.

The Speed Radius Index (SRI) is by convention a parameter used exclusively for calculation of theoretical speed of tractors. In no case SRI can be used as measurable value of rolling circumference.

Instead of W or W...L rims, the same size in DW or DWW may be used if the flange height is the same. (Designation of rims see pages 220.)

Old	Temporary	New	In millimetres
8	8.3/8	8.3	
9	9.5/9	9.5	240
10	11.2/10	11.2	280
11	12.4/11	12.4	320
12	13.6/12	13.6	340
13	14.9/13	14.9	380

Old	Temporary	New	In millimetres
14	16.9/14	16.9	420
15	18.4/15	18.4	460
16	20.8/16	20.8	520
18	23.1/18	23.1	
Sample			
13-28	14.9/13-28	14.9-28	380/85-28

Variation in load capacity with speed dependence

Tractor Radial & Diagonal

Speed (km/h)	0	5	10	15	20	25	30	35
Speed Category A6	+130%	+70%	+40%	+30%	+20%	+7%	(0)	-10%
A8	+130%	+70%	+50%	+34%	+23%	+11%	+7%	+3%
D	+130%	+70%	+40%	+34%	+23%	+18.5%	+15%	+12%

Speed (km/h)	40	45	50	55	60	65	70
Speed Category A6	-20%	–	–	–	–	–	–
A8	(0)	-4%	-9%	–	–	–	–
D	+9.5%	+7%	+5%	+3%	+1.5%	(0)	-9%

All Field Applications:

A6 Tyres – loads as in the Table

A8 Tyres – loads as in the Table plus 7%

The Inflation Pressure must be increased for:

- road transport and long-distance transport with semi-trailer +0.3 bar
- harvesting machines and front-end loader tractor application +0.4 bar

Tractor Front – Steering Wheels

Speed (km/h)	10 *	15	20	25	30	35	40	45
Speed Category A6	+50%	+43%	+35%	+15%	(0)	-10%	-20%	
A8	+67%	+50%	+39%	+28%	+11%	+4%	(0)	-7%

* Basic Inflation Pressure must be increased about 25%.

If a front-end loader is fitted on the tractor, +100% applies.

Explanations referring to IMP/MPT tyres

Tables on page 106 to 127 and 174 to 199

IMP = Implement tyres

MPT = Multi purpose tyres

Load capacity and speed

When determining the minimum tyre size necessary for a vehicle, the approved axle load and the maximum design speed of the vehicle should always be used as the basis.

Nominal load capacity = 100 % load, as indicated by the Load Index (LI), see page 13.

Tyre pressure

The tyre pressures given in the tables are minimum tyre pressures and should be used as a guide only.

The given max. air pressures may not be exceeded.

All tyre pressures refer to a “cold” tyre which has been standing outdoors for several hours, not exposed to intense sunlight.

The static radius is for the new tyre laden at the max. load capacity and at the corresponding tyre pressure as per the table concerned.

The rolling circumference corresponds to the max. load capacity (100%) and is inflated at the corresponding tyre pressure as per the table concerned. At 50% of the max. load capacity the rolling circumference is increased by approx. 1% for a radial tyre and by approx. 1.8% for a cross-ply tyre on the drive wheel of an agricultural tractor.

Rims. Only the rims indicated in this data book are approved for fitting to new vehicle series.

 – drive wheel

 – free rolling wheel

Variation in load capacity with speed dependence

AR-01, AR-02

Speed (km/h)		0	5	10	15	20	25	30	35	40
Speed Category	D	+95%	+87%	+75%	+60%	+50%	+40%	+35%	+30%	+24%
	F	+150%	+110%	+80%	+65%	+50%	+35%	+25%	+19%	+15%

Speed (km/h)		45	50	55	60	65	70	75	80
Speed Category	D	+17%	+11%	+7%	+3%	(0)	–	–	–
	F	+13%	+12%	+11%	+10%	+7.5%	+5%	+2.5%	(0)

Agriterra 02, Agriterra 03 & Agriterra 04

Speed (km/h)		0	5	10	15	20	25	30	35	40
Speed Category	D	+130%	–	+80%	+73%	+65%	+58%	+51%	+44%	+36%

Speed (km/h)		45	50	55	60	65	70	75	80
Speed Category	D	+29%	+21%	+14%	+7%	(0)	–	–	–

Implement, Implement Traction, Tractor Small – Free rolling

Speed (km/h)		0	10	15	20	25	30	35	40	45	50
A6 (30 km/h)	LLV	+65%	+29%	+21%	+14%	+7%	(0)	-5%	-10%	–	–
	HLV	+98%	+55%	+45%	+37%	+28%	+20%	+14%	+8%	–	–
A8 (40 km/h)	LLV	+65%	+40%	+33%	+26%	+19%	+12%	+5%	(0)	-5%	-10%
	HLV	+98%	+68%	+60%	+51%	+43%	+34%	+26%	+20%	+14%	+8%

Implement, Implement Traction, Tractor Small – Drive wheels

Speed (km/h)		0	10	15	20	25	30	35	40	45	50
A6 (30 km/h)	LLV	+135%	+29%	+21%	+14%	+7%	(0)	-5%	-10%	–	–
	HLV	+193%	+84%	+73%	+63%	+53%	+43%	+36%	+29%	–	–
A8 (40 km/h)	LLV	+135%	+40%	+33%	+26%	+19%	+12%	+5%	(0)	-5%	-10%
	HLV	+193%	+100%	+90%	+80%	+70%	+60%	+50%	+43%	+36%	+29%

LLV = Low Load Variation

HLV = High Load Variation, is where the tyre load varies by a factor of "2" or more between loaded and unloaded conditions.

The inflation pressure for HLV application must be increased, consult tyre manufacturer.

In the case of HLV, the maximum distance should not exceed 1 km. For a longer distance, consult tyre manufacturer.

Rim specification

Sample of rim marking

DW18L x 38	Meaning
DW	Rim Contour
18	Nominal Rim Width in inches
L	Flange Height code
x	One-piece rim
38	Nominal Rim Diameter in inches

Sample of rim marking

	Meaning
W	Wide Drop Centre – Single Well shape rim
DW	Wide Drop Centre – Double Well shape rim
SDC	Semi-drop Centre rim
-	Multi-piece rim
x	One-piece rim
H2	Double Hump
DC	Drop Centre rim

Nominal	D	Nominal	D
16"	405.6	34"	868.4
18"	462.0	36"	919.2
20"	512.8	38"	970.0
24"	614.4	42"	1 071.6
26"	665.2	46"	1 173.2
28"	716.0	48"	1 224.0
30"	766.8	50"	1 274.8
32"	817.6	54"	1 376.4

W and DW rims

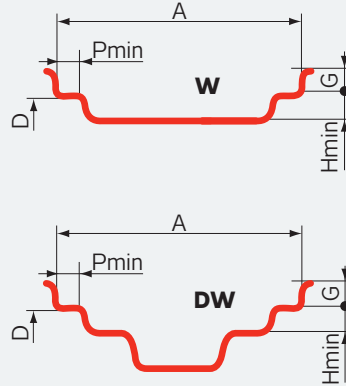

Rim	A	G	P min.	H min.
W6	152.5	22.5	23.5	20.5
W7	178.0	22.5	23.5	20.5
W8	203.0	22.5	23.5	20.5
W9	228.5	25.5	27.0	20.5
W10	254.0	25.5	27.0	20.5
W11	279.5	25.5	27.0	20.5
W12	305.0	25.5	27.0	20.5
W13	330.0	25.5	27.0	20.5
W8L	203.0	22.5	27.0	20.5
W14L	355.5	25.5	27.0	20.5
W15L	381.0	25.5	33.0	20.5
W16L	406.5	25.5	33.0	20.5
W18L	457.0	25.5	33.0	20.5
DW16L	406.5	25.5	50.5	27.0
DW18L	457.0	25.5	50.5	27.0
DW20B	508.0	29.0	50.5	27.0
DW21B	533.5	29.0	50.5	27.0
DW23B	584.0	29.0	50.5	27.0

5° Drop-centre rims

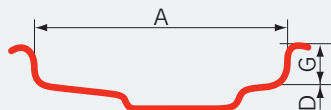

Rim	A	G	D
3.00B×10	76.0	14.1	253.2
3.50B×10	89.0	14.1	253.2
4J×10	101.5	17.3	253.2
4J×15	101.5	17.3	380.2
41/2K×15	114.5	18.0	380.2
5J×12	127.0	17.3	304.0
5J×14	127.0	17.3	354.8
5J×15	127.0	17.3	380.2

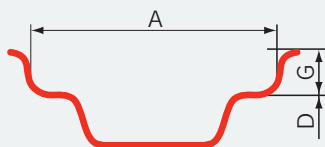

Rim	A	G	D
4.00E×12	101.5	20.0	304.0
4.00E×16	101.5	20.0	405.6
4.50E×16	114.5	20.0	405.6
5.00F×16	127.0	22.5	405.6
5.00F×20	127.0	22.5	512.8
5JA×12	127.0	16.0	304.0
5.50F×16	139.5	22.5	405.6
5.50F×20	139.5	22.5	512.8
6.00F×16	152.5	22.5	405.6
6.00F×20	152.5	22.5	512.8
7.00×12	178.0	20.5	304.0
7.00×15	178.0	20.5	380.2
7.00I-16 **	178.0	16.0	405.6

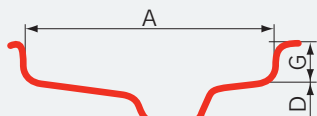

Rim	A	G	D
9×18	228.5	25.5	462.0
9.00×12	228.5	19.0	305.6
9.00×15.3	228.5	19.0	388.8
11×18	279.5	25.5	462.0
12×18	305.0	25.5	462.0
13×17	330.0	25.5	436.6
13.00×17	330.0	19.0	436.6
16.00×17	406.5	19.0	436.6

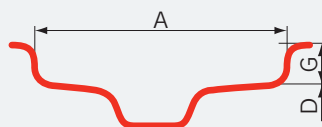

Rim	A	G	D
2.50×8	63.5	14.0	202.4
2.50A×8	63.5	11.5	202.4
3.00D×8	76.0	17.5	202.4
3.00D×10	76.0	18.0	253.2
3.00D×12	76.0	18.0	304.0
3.00D×15	76.0	18.0	380.2

Rim specification (continued)

15° Drop-centre rims

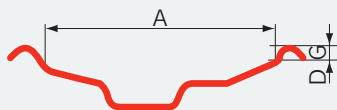

Rim	A	G	D
6.75 × 14.5	171.5	12.7	368.3
10.50 × 17.5	266.5	12.7	444.5
11.75 × 22.5	298.5	12.7	571.5
13.00 × 15.5	330.0	12.7	393.7
14.00 × 22.5	355.6	12.7	571.5
16.00 × 22.5	406.4	12.7	571.5
20.00 × 22.5	508.0	12.7	571.5
AG20.00 × 26.5	508.0	12.7	673.1
AG24.00 × 26.5	609.5	12.7	673.1
AG20.00 × 30.5	508.0	12.7	774.7

5° Semi drop-centre rims

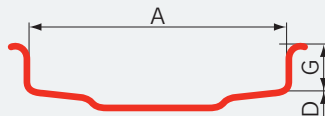

Rim	A	G	D
13 × 20 SDC	330.0	25.5	512.8

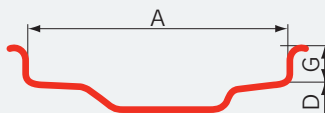

Rim	A	G	D
13LB × 15	330.2	11.0	380.2

5° Divided rims

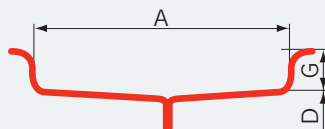

Rim	A	G	D
2.10-4 *	53.5	12.0	100.8

5° Tapered rim

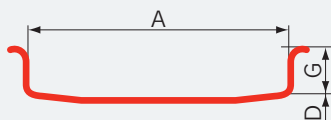

Rim	A	G	D
7.0-401.5	178.0	38.0	401.5

D Specified diameter (mm)

* divided rim

** multi-piece rim



Terms and abbreviations used in this catalogue

Acronyms	Meaning	Definition
PR	Ply Rating	Identifies different versions (load capacity/inflation pressure) of tyres having the same size designation.
TYPE	Tubeless or Tube Type	Tubeless (TL) – Tyres specifically designed for fitment without an inner tube on appropriate rims. Tubeless tyres may be used with a tube.
LI	Load Index	Is a numerical code associated with the maximum load a tyre can carry at the speed indicated by its Speed Symbol under service conditions specified by the tyre manufacturer.
SS	Speed Symbol	Indicated the maximum speed at which the tyre can carry a load corresponding to its Load Index under service conditions specified the tyre manufacturer.
	Free Rolling Wheels	Free rolling wheels, that not transmit motion, e.g. trailer
	Drive Wheels	Drive wheels, that transmit motion, e.g. drive wheel axle on tractors
RIM	Recommended Rim	The rim which gives the best fitment of the tyre for all conditions and types of service.
RIM (PERMITTED)	Permitted Rim	Any rim which can be permitted in addition to the recommended rim.
	New Tyre Dimensions	The dimensions of an unloaded new tyre mounted on its Measuring Rim at the recommended inflation pressure and allowed to stand for a minimum of 24 hours at normal room temperature before readjustment of the pressure back to its original level.
	Section Width (design)	The linear distance between the outsides of the sidewalls of an inflated new tyre excluding elevations due to labelling (marking), decorations, or protective bands or ribs.
	Overall Diameter (design)	The diameter of an inflated tyre at the outermost surface of the tread.
	Static Radius (theoretical nominal)	The radius of the new tyre loaded at the maximum load capacity and with the corresponding tyre pressure.
	Rolling Circumference (theoretical nominal)	The circumference of the tyre loaded at the maximum load capacity and with the corresponding tyre pressure.

Acronyms	Meaning	Definition
LOAD CAPACITY	Tyre Load Carrying Capacity	The maximum load (kg) a tyre is permitted to carry under specified operating conditions. In the case of twin-fitted driven wheels, a factor of 1.76 is applied to the load capacity of a single fitment tyre.
	Inflation Pressure	The “cold” pressure (kPa) of the fluid with which the tyre is inflated.
HLV	High Load Variation	Is where the tyre load varies by a factor of “2” or more between loaded and unloaded conditions. The inflation pressure for HLV application must be increased, consult tyre manufacturer. In the case of HLV, the maximum distance should not exceed 1 km and maximum speed 10 km/h. For a longer distance or higher speed, consult tyre manufacturer. Example of purpose: without HLV – normal use with constant load in transport service, on tractor in field service, e.g. trailer, tractor; with HLV – use with various load conditions, factor > 2 between loaded and unloaded, e.g. loaders
LLV	Low Load Variation	Standard application with low load difference between loaded and unloaded conditions.
WATER 75%	Capacity of Water	Capacity of water for Water balasting.
ETRTO	The European Tyre and Rim Technical Organisation	Data in this Technical Databook are relevant with ETRTO standards, the further data you can find there.
SRI	Speed Radius Index	The Speed Radius Index is by convention a parameter used exclusively for the calculation of the theoretical speed of tractors during European Union homologation procedures and for interchangeability of different tyre sizes.
	Nominal Section Width	The section width of an inflated tyre mounted on its theoretical rim and indicated in the tyre size designation.
IND		Agricultural tyres for traction wheels for construction applications with load capacities and inflation pressures which differ from those for tyres which the same size designation for use on agricultural tractors.
REINFORCED		Tyres with better protection against tyre damage (puncture). The load capacity and tyre dimensions stay like standard execution.

Trelleborg Wheel Systems Czech Republic a.s.
Švehlova 1900/3, 106 00 Prague 10, Czech Republic



Trelleborg Wheel Systems is fully compliant with the limits on Polycyclic Aromatic Hydrocarbons (PAHs) determined by the European Directive EC/2005/69 and REACH Regulation EC/1907/2006, since December 1st 2009.

© TWS CZ : 09/2019// Magic Seven
Subject to technical amendments,
printing errors and mistakes in text or illustrations.



Your Distributor/Dealer:

Mitas

mitas-tyres.com